

TRACKING BIASES CAUSED BY IMPERFECTIONS IN DLL RECEIVERS

Gerhard Hejc and Wolfgang Schaefer
TimeTech GmbH
D-70569 Stuttgart, Germany

Abstract

Delay Lock Loop (DLL) is a feedback system that is able to track the code phase of a pseudo-noise (PN) signal. Imperfections in the DLL or the RF front end may or may not lead to tracking biases, which have to be removed by a receiver-specific calibration factor. The goal of this work is to show that also imperfections (spectral asymmetry of the signal, carrier-phase imbalance of the DLL), which do not change the code phase, can result in significant biases when both effects are combined.

I INTRODUCTION

GNSS signals are generated by the modulation of a sinusoidal carrier with a spreading code and navigation data. Neglecting multipath [1], the received signal from one satellite is given by

$$S_R(t) = \sqrt{2C}D(t - \tau(t))PN(t - \tau(t))\cos(2\pi f_0 t + \varphi(t)) + n(t) \quad (1)$$

where t is the actual time in the receiver time scale and C is the power of the received signal. The navigation data $D(t)$ takes only +1 or -1 values (NRZ modulation) and the spreading code $PN(t)$ is the pseudo-random code sequence. $\tau(t)$ and $\varphi(t)$ are code and carrier phase due to the signal propagation over the distance between receiver and transmitter, including biases induced by propagation path, clock errors, and relativistic effects, and f_0 is the carrier frequency. $n(t)$ summarizes all noise contributions of receiver, antenna, and environment.

Code phase measurements are realized with a Delay Locked Loop (DLL), which is able to track the phase of the pseudo-random modulation of the signal by synchronizing it with a local replica of the code. The in-phase and quadrature component of the received signal is correlated with the advanced (early) and delayed (late) local code replicas.

$$\begin{aligned} PN_E(t) &= PN\left(t - \tau_0 + \frac{T_C}{2}\right) \\ PN_L(t) &= PN\left(t - \tau_0 - \frac{T_C}{2}\right) \end{aligned} \quad (2)$$

A code-tracking loop can be designed as coherent or non-coherent DLL. The coherent DLL requires that the carrier tracking loop is locked and the navigation data bits have been removed, while the non-coherent DLL is able to track the code without these restrictions. An overview of these DLL types can be found in the next table:

Table 1. Properties of coherent, non-coherent, and SATRE DLL.

DLL Type	Algorithm	Normalized Signal	Error	Properties
Coherent DLL	$I_E - I_L$	$D \cos(\Delta\phi) \sqrt{C} \frac{2}{T_C} \Delta\tau$		Data removal and carrier-phase control needed
Non-coherent DLL	$I_E^2 - I_L^2 + Q_E^2 - Q_L^2$	$\frac{2C}{T_C} \Delta\tau$		Independent of data and carrier-phase error
SATRE DLL	$I_E^2 - I_L^2$	$\frac{2C}{T_C} \Delta\tau$		Similar properties as non-coherent DLL

where I_E and I_L are the in-phase early and late auto correlation function, and Q_E and Q_L are the quadrature early and late auto correlation function. The range of the normalized error signal is $[-T_C/2..T_C/2]$ in all three cases and $\Delta\tau = \tau - \tau_0$ is the difference between received and local code phase.

In the SATRE receiver [2,3], a non-coherent DLL is used; therefore, the focus of this article is on this DLL type. The S-curves for these three types of DLL's are shown in the next figure.

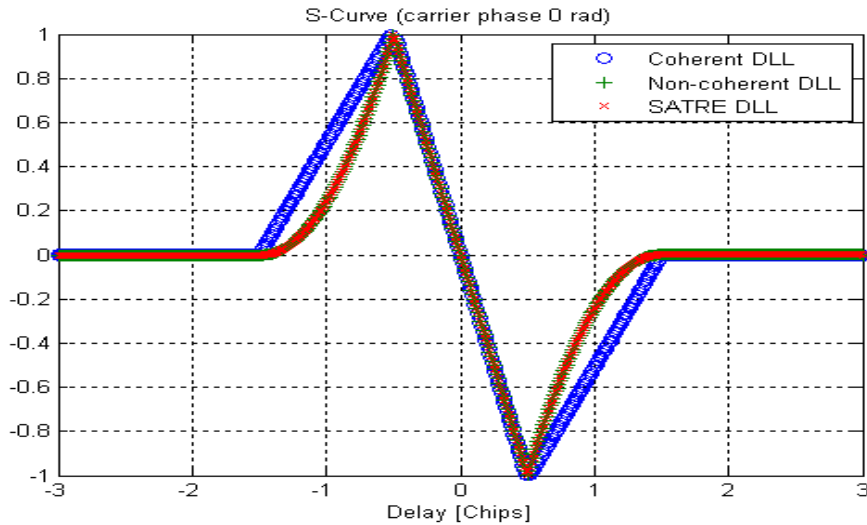

Figure 1. S-Curve of coherent, non-coherent, and SATRE DLL.

Phase and amplitude imperfections in the DLL lead to systematic biases of the S-curve zero-crossing compared to the ideal case. Also, asymmetries and imperfections in the bandpass filtering of the incoming signal introduce unknown delays. The purpose of this paper is to study the effect of these contributions using a simplified receiver model.

II IMPERFECT DLL

In this work, we only study systematic effects introduced by a non-ideal signal or DLL and, therefore, set the noise contribution to zero. Also, the data modulation is neglected.

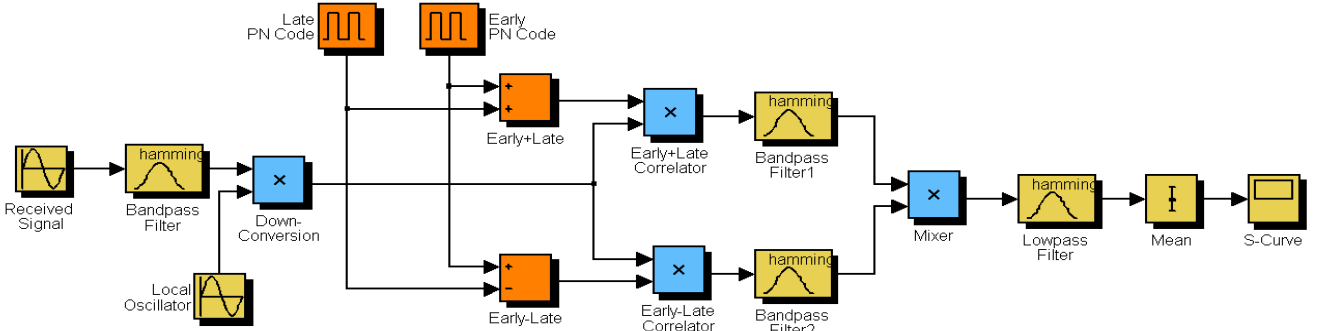

Figure 2. Simulation model of the SATRE Receiver (RF front-end + DLL).

After the down-conversion, the received signal is correlated with the early plus late and the early minus late code replica, which is filtered with narrow-band bandpass filters. The resulting signals in both arms are given by

$$(R_{PN}(\Delta\tau - T_C/2) - R_{PN}(\Delta\tau + T_C/2)) \cos(\Delta\omega t + \Delta\phi_1) \quad (3)$$

$$(R_{PN}(\Delta\tau - T_C/2) + R_{PN}(\Delta\tau + T_C/2)) \cos(\Delta\omega t + \Delta\phi_2) \quad (4)$$

where $\Delta\omega = \omega_0 - \omega_{LO}$, $\Delta\phi = \phi - \phi_{LO}$ and $R_{PN}(\Delta\tau \pm T_C/2)$ are the auto-correlation function of the incoming PN code with the early and late code replica. The carrier phase in the early-plus-late correlator arm is $\Delta\phi_1$ and in the early-minus-late correlator arm is $\Delta\phi_2$.

The final mixer removes the residual carrier and only a contribution of the carrier-phase difference between the correlator arms remains in the case of an imperfect DLL. The auto-correlation functions of both arms from (3) and (4) are multiplied together, yielding an early-squared-minus-late-squared discriminator.

(5)

$$(R_{PN}(\Delta\tau - T_C/2)^2 - R_{PN}(\Delta\tau + T_C/2)^2)\cos(\Delta\varphi_{12})$$

where the term $\Delta\varphi_{12} = \Delta\varphi_1 - \Delta\varphi_2$ is called the carrier phase imbalance. The effect of this imbalance can be seen in the next figure.

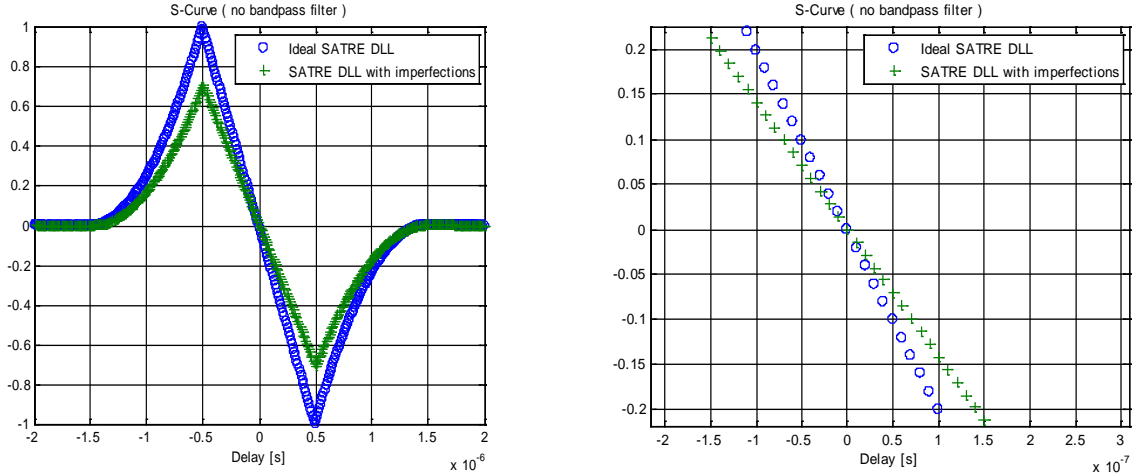

Figure 3. Effect of carrier-phase imbalance on the S-curve in the case of an ideal signal.

A carrier-phase imbalance does not lead to a shift of the zero-crossing of the S-curve; only the slope changes.

III SPECTRAL ASYMMETRY

The RX filter affects both the code and carrier phase and, therefore, leads to a tracking bias proportional to the group delay of the filter. To distinguish the group delay contribution from the effect introduced by a filter asymmetry, we construct a bandpass filter from a low-pass and high-pass FIR filter, which have a constant group delay proportional to the filter order.

The tracking bias introduced by a symmetric and asymmetric RX filter after group delay compensation can be seen in the next figure.

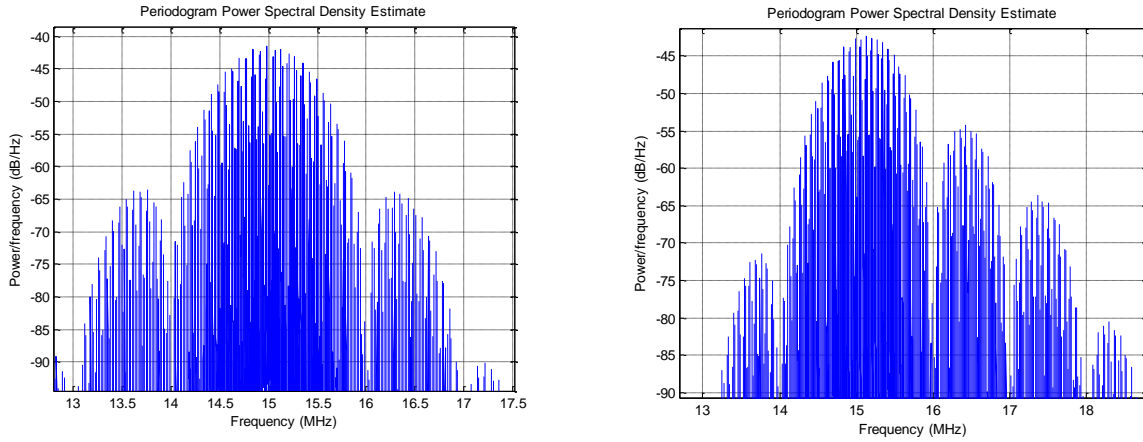

Figure 4. Symmetric and asymmetric RX filter.

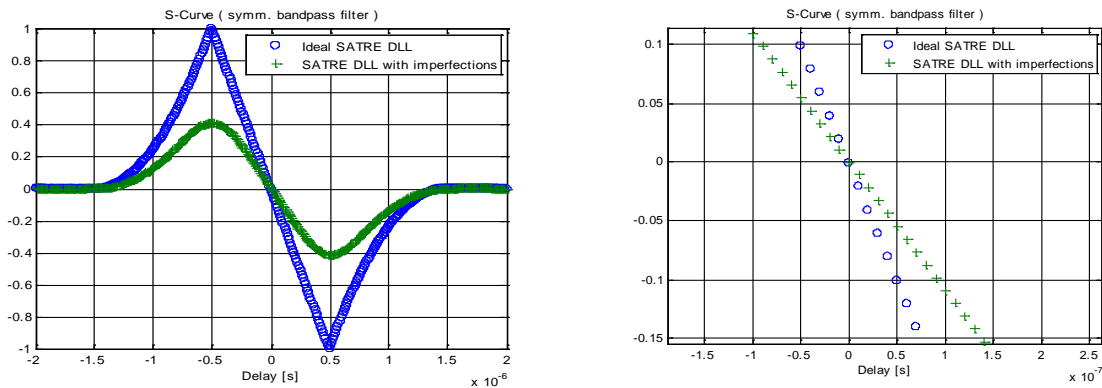

Figure 5. Effect of a symmetric RX filter on the S-curve in the case of ideal DLL.

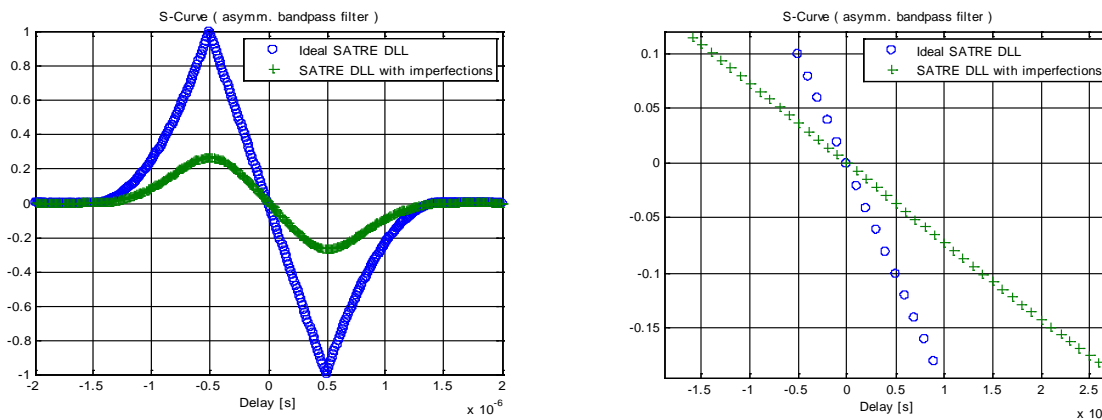

Figure 6. Effect of an asymmetric RX filter on the S-curve in the case of an ideal DLL.

Neither a symmetric nor an asymmetric RX filter shifts the zero-crossing of the S-curve relative to the case with no filter (after a group-delay compensation).

IV RESULTS

The result for the case of a non-ideal DLL with a carrier-phase imbalance together with an imperfect signal can be seen in the next figure.

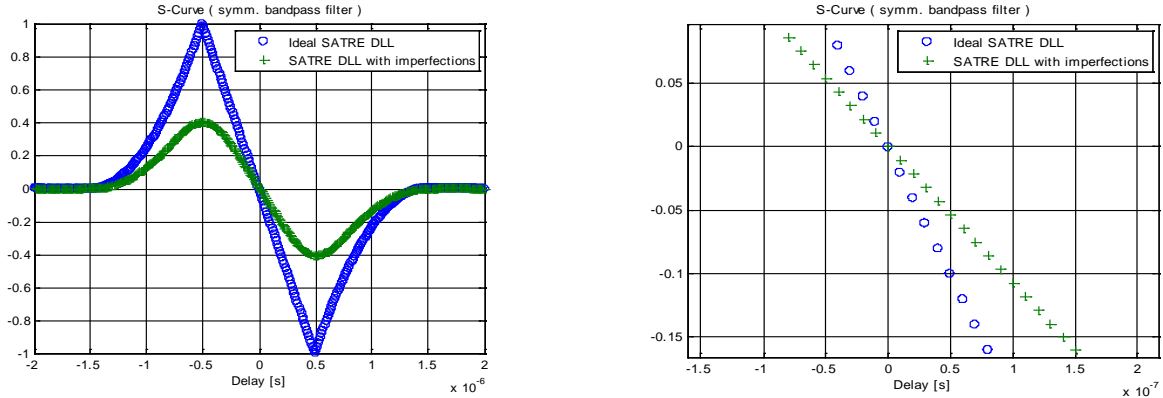

Figure 7. Effect of a symmetric RX filter in combination with a non-ideal DLL (carrier-phase imbalance).

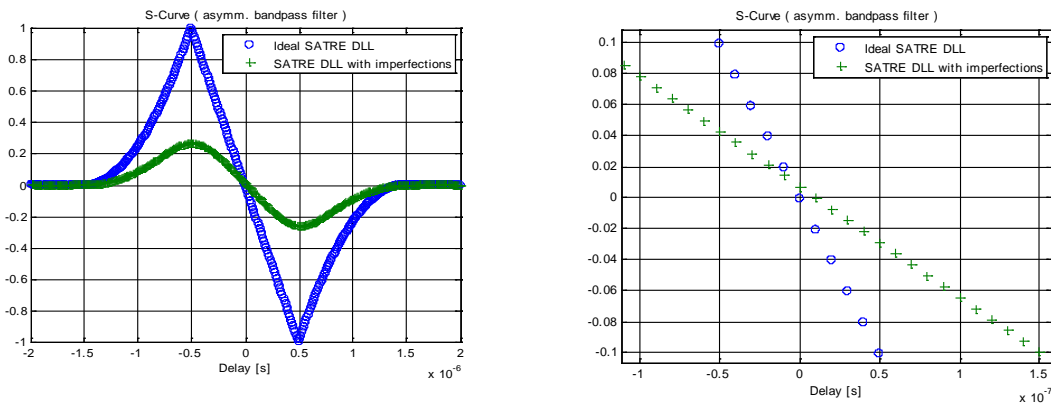

Figure 8. Effect of an asymmetric RX filter in combination with a non-ideal DLL (carrier-phase imbalance).

If a carrier-phase imbalance is present, an asymmetric RX filter leads to a small shift of the zero-crossing of the S-curve compared to the symmetric case, where no bias is present.

As an example, we consider a worst-case asymmetry between the first left and right side lobe of the received signal of 8dB and a carrier-phase imbalance between different receivers of 5 degrees. The resulting bias is $5.1\text{ns} \pm 0.3\text{ns}$ (chip rate 1Mchip/s).

V CONCLUSIONS

The analysis was based on the actual, analog implementation of SATRE receiver and studied the effects of imperfections in the DLL and in the signal. The main result is that neither an asymmetric RX filter nor

a carrier-phase imbalance alone leads to a tracking bias, but a combination of both effects gives a bias in the order of several ns (worst case). Recent observations show that similar effects are present in digital receivers.

Receiver-based tracking bias must be removed by calibration. In the case of CDMA systems, where each satellite is sending its own code on the same frequency, one receiver-specific calibration factor is sufficient for this purpose.

In the case of FDMA systems, where more than one frequency is present, an asymmetric RX filter will look more asymmetric for frequencies farther away from the center frequency and, therefore, leads to different biases. In such a case, a different calibration factor for each satellite link must be applied in addition to the receiver-specific calibration factor.

VI REFERENCES

- [1] F. G. Ascarrunz, T. E. Parker, and S. T. Jefferts, 1999, “*Pseudo-Random Code Correlator Timing Errors Due To Multiple reflections In Transmission Lines,*” in Proceedings of the 30th Annual Precise Time and Time Interval (PTTI) Systems and Applications Meeting, 1-3 December 1998, Reston, Virginia, USA (U.S. Naval Observatory, Washington, D.C.), pp. 433-437.
- [2] D. Kirchner, 1991, “*Two-Way Time Transfer via Communication Satellites,*” in **Proceedings of the IEEE, 79**, 983-990.
- [3] W. Schaefer, A. Pawlitzki, and T. Kuhn, 2000, “*New Trends In Two-Way Time and Frequency Transfer via Satellite,*” in Proceedings of the 31st Annual Precise Time and Time Interval (PTTI) Systems and Applications Meeting, 7-9 December 1999, Dana Point, California, USA (U.S. Naval Observatory, Washington, D.C.), pp. 505-514.

