

## TIMING ACTIVITIES AT INRIM IN THE FRAME OF THE GALILEO PROJECT

I. Sesia, G. Cerretto, and P. Tavella,  
Istituto Nazionale di Ricerca Metrologica (INRiM), Torino, Italy  
*p.tavella@inrim.it*

### Abstract

*Since 1999 different timing activities at the INRiM (formerly IEN G. Ferraris) are devoted to the development of the European Satellite Navigation System Galileo, in collaboration with European space industries and the European Space Agency (ESA). Currently four main projects are in progress.*

*In early 2006, an experimental phase called “Galileo System Test Bed V2 (GSTB V2)” or “GIOVE Mission” has been launched, supported by ESA, and INRiM takes part in it, hosting a Galileo prototype receiver connected to the time reference signals, and analyzing the data coming from the first experimental Galileo satellites in order to characterize the onboard clocks.*

*In addition, INRiM is also involved in the Galileo development (phase CDE1), supported by ESA, by designing the time scale algorithm of one of the Galileo ground time laboratories named the Precise Time Facility.*

*A consortium of different industries and UTC(k) laboratories are developing the prototype of the Galileo Time Service Provider, supported by the European Union, with the aim to provide to the Galileo system the necessary corrections to maintain the Galileo system time in agreement with UTC. INRiM contributes as one of the UTC(k) laboratories, supporting also the algorithm, standardization, and BIPM interface activities.*

*Recently, INRiM began to develop an integrity algorithm for monitoring the clock and identifying possible malfunctioning.*

## INRIM, THE ITALIAN NATIONAL INSTITUTE OF METROLOGICAL RESEARCH

On 1 January 2006, the Istituto Elettrotecnico Nazionale “Galileo Ferraris” (IEN) and the Istituto di Metrologia Gustavo Colonnetti (IMGC), merged to establish the Istituto Nazionale di Ricerca Metrologica (INRiM) [1].

INRiM is the national public body with the task of carrying out and promoting scientific research in metrology. Its research activities in measurement science, materials science, and innovative technologies are recognized worldwide. With the handover of the tasks of the primary metrology institute previously

assigned to IMGC and IEN, INRiM has become the focus of most scientific metrology activities in Italy, except for the field of ionizing radiations, where ENEA-INMRI maintains its role, with ENEA continuing to report to the Ministry for Economic Development (MiSE).

INRiM carries out studies and research on the realization of primary measurement standards for the basic and derived units of the International System of units (SI). It assures the maintenance of such standards, their international comparison, the dissemination of SI units, and in general provides measurement traceability to the SI units. In addition to physical and engineering metrology, its main R&D areas are in fundamental physical constants, materials, metrology for chemistry, health and environment, nanotechnology, innovation, quantum information, and computer vision.

Furthermore, INRiM:

- undertakes, promotes, and coordinates scientific and technological research projects, often in liaison cooperation with the European Union and international bodies, both through resources of its own and through programs of collaboration with universities and other national or international public and private organizations;
- promotes and coordinates the participation of Italy in international organizations, projects, and initiatives;
- supplies scientific expertise and advisory services;
- carries out communication and promotion activities concerning research;
- circulates its economic and social results on a national scale;
- promotes the technical and professional education and growth of its staff and personnel, also by awarding scholarships, and supporting PhD theses;
- provides technical and consultancy services to other scientific bodies, public administrations, companies or other private organizations;
- provides technological transfer for social and economic aims through the communication of scientific results;
- provides high-level calibration services to third parties under private law;
- participates in evaluation of research and structures;
- independently operates the national accreditation body for calibration laboratories (SIT).

INRiM has its main premises in Torino, Strada delle Cacce, and operational centers at the Politecnico of Torino – Dipartimento di Ingegneria Aeronautica e Spaziale – and the Università di Pavia – Dipartimento Chimica Generale.

The OPTICS Scientific Division – structured as depicted in Figure 1 – and in particular the OT2 project “Algorithm and satellite navigation,” is the structure involved in the activities described in this paper, also taking advantage of the collaboration with the OT2 group of “Time scale and synchronization.”

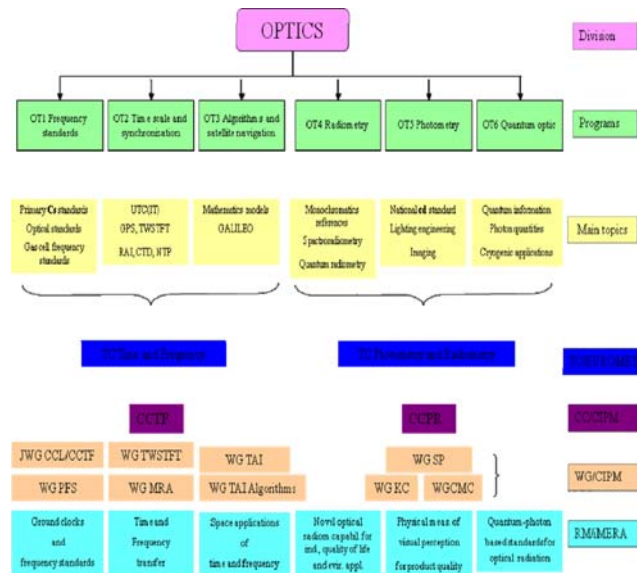

Figure 1. OPTICS division organization [1].

Since 1998, different timing activities at the INRIM have been devoted to the development of the European Satellite Navigation System Galileo, in collaboration with European space industries and the European Space Agency (ESA).

Concerning the Galileo project, the INRIM team was involved in:

- Autonomous Ephemerides Determination, ESA, 1998;
- Comparative System Study, ESA, 1999;
- GEMINUS, CE, 2000;
- GALA, CE, 2000;
- GALILEOSAT, ESA, 2000;
- GalileoSat Time Interface Working Group, ESA, 2000-2001;
- GALILEO Phase B2, ESA, 2002;
- GALILEO Phase B2 Consolidation, ESA, 2002;
- Galileo System Test Bed V1 (GSTB-V1), ESA, 2002-2005;
- Galileo Phase C0, ESA, 2003-04;
- Galileo Time Service Provider (TSP), GJU CE, 2004-2005;
- Galileo System Test Bed V2 (GSTB-V2), ESA, 2005-2007;
- Galileo Time Service Provider (TSP), GJU CE, 2005-2008;
- Galileo Time Service Provider (TSP), GJU CE, 2005-2008;
- Precise Timing Facility (PTF), ESA, 2005-2008;
- PROGENY, GJU CE, 2005-2007.

INRiM was invited in the ESA Working Group on Galileo Time Interface, and Dr. Patrizia Tavella was the Co-chairperson with Dr. Laverty of the English NPL.

## GSTB-V1 AND E-PTS

The Galileo System Test Bed V1 (GSTB-V1) [2] was the first experimental phase in the Galileo project, supported by the European Space Agency (ESA) and performed in 2004 and 2005. The aim was testing the Galileo algorithms in a mixed configuration where the space segment was given by the existing GPS constellation, while the ground segment was an experimental setup as close as possible to the Galileo architecture.

In the framework of GSTB-V1, Alenia Spazio and INRiM (formerly, the Istituto Elettrotecnico Nazionale - IEN), had the responsibility to design and realize an infrastructure able to generate the Experimental Galileo System Time (E-GST) and then provide a set of experiments dedicated to an assessment of the Galileo time scale.

The infrastructure that allowed the realization of E-GST was the Experimental Precise Timing Station (E-PTS), which was implemented at the INRiM. E-GST was obtained by a set of algorithms implemented in dedicated software (SW) that daily was able to generate the time scale of the GSTB-V1 system. In addition, off-line alternative time scale algorithms, as well as different clocks ensembles, measurement systems, and remote synchronization techniques, were used to test the stability and accuracy performances of the resulting time scale.

The behavior of the time scale realized at INRiM during the GSTB-V1 experiment is reported in Figure 2, where the time offset between E-GST and the Universal Coordinated Time (UTC) modulo 1 second is reported starting from 5 March 2004 to the end of November 2004. Further details on E-PTS performance assessment can be found in [3].

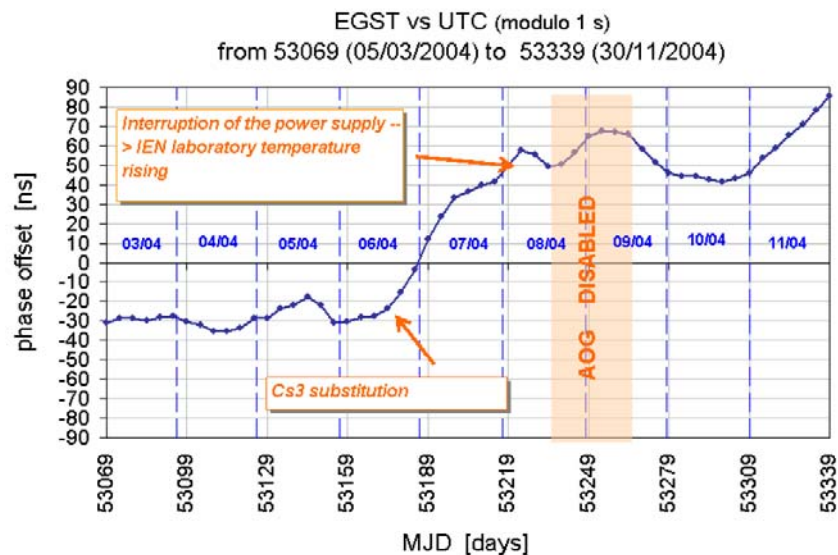

Figure 2. Time offset between E-GST and UTC (modulo 1 s), as evaluated at INRiM during GSTB-V1.

During the “GalileoSat Definition Phase” – an early experimental stage – the GSTB has been defined as an integral part of the “Galileo Design Development and Validation Phase,” in order to mitigate program risks [4-6]. The main goal for the GSTB first stage was to verify, in a real context, the Galileo concepts defined for the following “Galileo B2” phase. These major objectives have been pursued, realizing an

infrastructure close to the final Galileo setup, where the timekeeping algorithms could be implemented and tested continuously for a significant period (12 months).

With more details, the timing infrastructure inside the GSTB-V1, suitably designed to experiment with the Galileo System Time algorithms, was the E-PTS (Experimental Precise Timing Station). It was an infrastructure able both to generate the reference time (Experimental Galileo System Time- E-GST) for the whole GSTB-V1 and to provide all the data needed to realize a large set of timing experiments. Moreover, as a prototype of the final Galileo System Time (GST), the E-GST needed to have optimal characteristics for navigation and time dissemination purposes.

The use of E-GST as a reference time of GSTB V1 activities required that E-GST be realized in real time and with an hardware representation. In fact, a GPS geodetic receiver, which was part of the GSTB-V1 sensor stations network, has to be referenced to a signal representing the E-GST. In this way, the E-GST was injected in the OD&TS (Orbit Determination and Time Synchronization) algorithms. In addition, the E-GST algorithm had to be robust and flexible to fulfill the GST aims and allow further modifications.

To accomplish to these different scopes, the reference time scale has been realized in two versions:

- *a real time version*, as a fundamental part of the E-PTS infrastructure, giving the time reference to the OD&TS process via the E-PTS sensor station;
- *offline version*, mainly intended to test the various time scale and steering algorithms.

The E-PTS infrastructure, that provided the E-GST, was installed at INRiM using the facilities and personnel of the INRiM Time & Frequency laboratory, in collaboration with Alenia Spazio.

The E-PTS infrastructure, depicted in Figure 3 and installed during the year 2003, partially re-used the infrastructure of the INRiM Time and Frequency laboratory, in particular the INRiM clock ensemble and the remote transfer equipment, limiting the new hardware installation at the GSTB-V1 experimental stage [7,8]. All the other equipment, especially procured for E-PTS, were all located in dedicated rack hosted at INRiM.

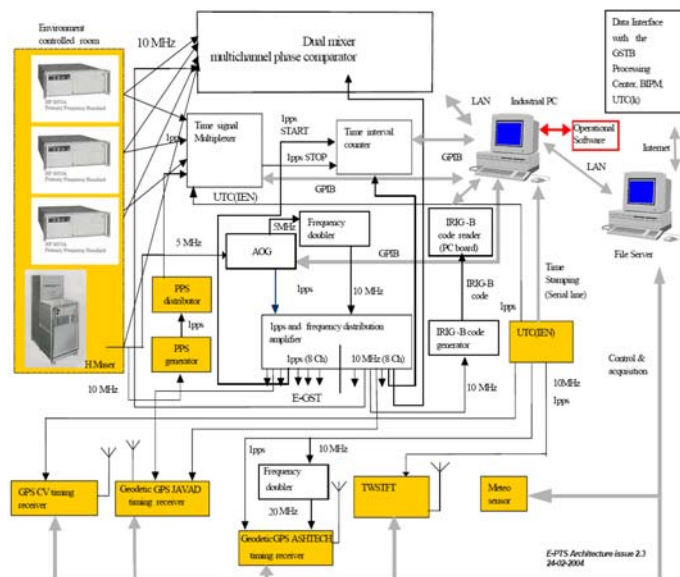

Figure 3. E-PTS architecture [8].

The E-PTS architecture, pointing out the six major elements that composed it, was [8]:

- Atomic clock ensemble;
- Hardware for the real-time E-GST generation;
- Local measurement system;
- Hardware and software for the time scale calculation and the data exchange;
- Remote synchronization hardware for the E-GST comparison with external UTC laboratories;
- Sensor station.

In the experimental phase, concerning time and frequency activities, the target requirements were reached [9] and the baselines for the future realization of GST algorithm set, while the E-PTS installation and the first months of its operation provided some important feedbacks for the future realization of the Galileo PTF implementation, basically:

- The PTF infrastructure has to be designed with a large instrument redundancy, since a failure in critical timing equipment impacts directly the performance at the system level;
- The long lead items (e.g., AOG, H-maser) need to be procured as soon the realization phase starts;
- The SW architecture could be revised to take into account for the different tasks in the GST generation process: for instance, the continuous acquisition of clock measures has to be guaranteed even other SW parts are in failure;
- All the PTF equipment should be located in environmentally controlled rooms to avoid thermal instability effects.

## **GSTB-V2, THE GIOVE MISSION**

As described in the previous section, for the development of the Galileo system, the European Space Agency launched in 2002 the development of an experimental ground segment (Galileo System Test Bed Version 1). Within the GSTB-V1 project, tests of Galileo algorithms were conducted, taking into account, for GPS satellites, an experimental ground segment consisting of a worldwide network of sensor stations, an Experimental Precision Timing Station providing the reference time scale, and a Processing Center located at ESA/ESTEC in The Netherlands.

The following step after GSTB-V1 was the second version of the Galileo System Test Bed (GSTB-V2) or GIOVE (Galileo In-Orbit Validation Element) mission. Within the GIOVE Mission, two experimental satellites called GIOVE-A and GIOVE-B have been launched. They mark the first step in the validation of the Galileo system to be completed with the deployment of the In-Orbit Validation (IOV) satellites. The GIOVE-A satellite has been developed by Surrey Satellite Technology Ltd. (UK), whilst GIOVE-B satellite has been developed by a consortium of European industries led by the firm Austrium of Germany. GIOVE-A spacecraft was launched on 27 December 2005, and its payload includes two Rubidium Atomic Frequency Standards (RAFS), while the GIOVE-B spacecraft was launched on 26 April 2008 and its payload includes one Passive Hydrogen Maser (PHM) and two RAFS.

The overall GIOVE core infrastructure for experimentation consists mainly of a network of 13 Galileo Experimental Sensor Stations (GESSs) worldwide distributed to acquire and collect the GIOVE and GPS

satellite signals and to send pseudorange and carrier-phase measurements to a Ground Processing Center (GPC) located at ESTEC, in the Netherlands. One of these Ground Sensor Stations is located at INRiM, and it is connected to an Active Hydrogen Maser that realizes the reference time scale for the GIOVE Mission, to which all the system clocks are referenced and, hence, evaluated. Moreover, Satellite Laser Ranging (SLR) stations send ground-to-satellite distance measurements to the GPC as well.

The main objectives of the GIOVE Mission were related to Signal-in-Space occupation and validation, the monitoring of Galileo in-orbit environment, and the validation and characterization of onboard clock technologies.

In particular, INRiM is in charge of the GIOVE onboard clock performance assessment, which is based on the GIOVE measurement system and the so-called Orbit Determination and Time Synchronization (ODTS) process [10].

As an example of onboard GIOVE clocks characterization, Figure 4 presents the Allan deviation of PHM onboard GIOVE-B, RAFS onboard GIOVE-A, together with all GPS onboard clocks, as estimated by the ODTS over the period from 1 November 2008 to 5 November 2008. A detailed assessment of in-orbit performance of GIOVE clocks can be found in [11].

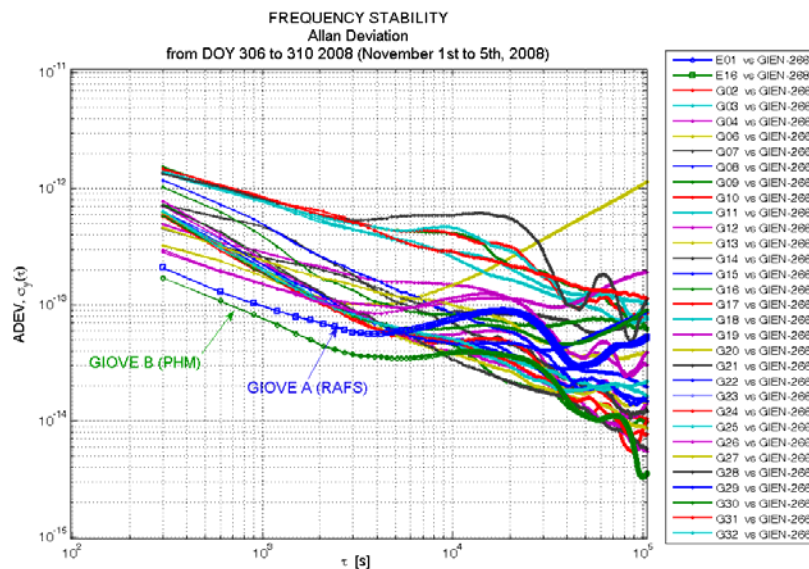

Figure 4. Example of frequency stability of PHM (GIOVE-B), RAFS (GIOVE-A) and GPS clocks.

An additional mission goal is the implementation and evaluation of an experimental version of the so-called GPS to Galileo Time Offset (EGGTO), i.e. the predicted difference between the GPS and Galileo system times. This predicted offset will allow the user of a dual GPS/Galileo receiver to obtain a combined navigation solution from pseudorange measurements to the GPS and GIOVE satellites.

An example of EGGTO experimental results obtained during GIOVE Mission is reported in Figure 5. Further details can be found in [12].

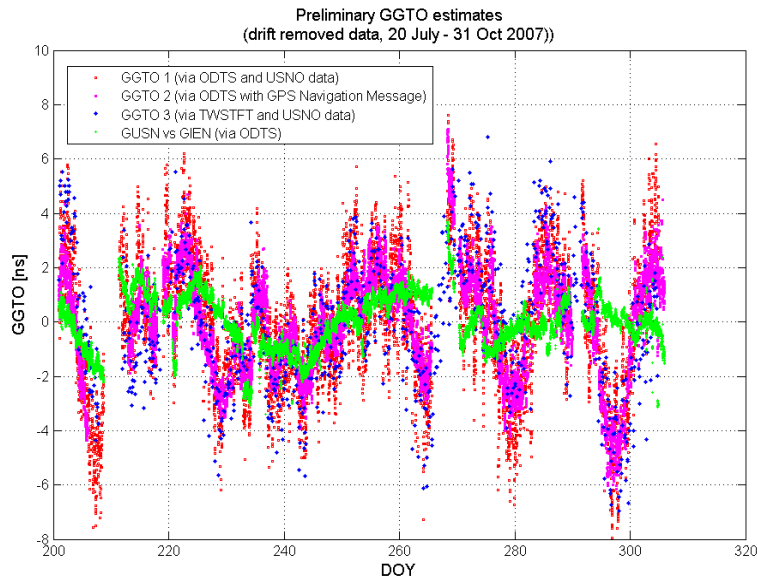

Figure 5. Example of EGGTO experimental results obtained during GIOVE Mission.

## PRECISE TIME FACILITY (PTF)

The Precise Time Facility (PTF) [13] represents a key aspect in the Galileo System function.

The PTF can be considered the modern version of the clock invented by John Harrison in the 18th century to solve the Longitude determination problem of maritime navigation. The PTF is actually in charge to generate the physical time scale of Galileo, the Galileo System Time (GST), with two main purposes:

- Metrological Timekeeping: this function is implemented by the PTF with the support of the Time Service Provider (TSP), UTC (k) labs, and BIPM;
- Navigation Timekeeping: this is a critical task for Navigation, needed for orbit determination and prediction, to be ensured even in lack of TSP.

The operational scenario of the PTF is shown in Figure 6.

The key functional and design requirements of the PTF are:

- Unmanned Operations with Error & Anomaly management, under Remote Control & Monitoring by GMS Control Elements;
- Cooperation with the Time Service Provider (TSP), i.e. acceptance of Steering corrections and supply of GST (MC)-to-TAI offset measurement data;
- Master/Slave Operational Modes (with respect to the second PTF), Autonomy Mode in case of TSP loss;
- Supply of the GST (MC) signals to the co-located Galileo Sensor Station (GSS) for measurement of the Galileo Satellite clocks;
- Reliability (including redundancy handling), Availability, Maintainability, and Safety to ensure the coverage of the entire Galileo operational life;



- SW Quality in front of the Galileo SW Standards to satisfy the needs of safety critical applications.

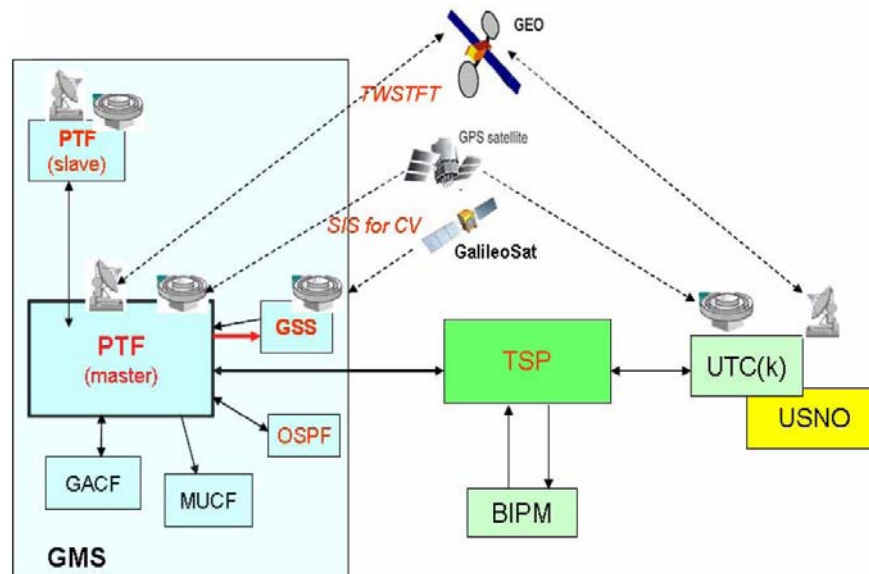

Figure 6. PTF operational scenario [13].

The main functions to be implemented by the PTF are the GST Generation chain and the Time Transfer and are operated under the PTF monitor & control functions.

The GST Generation chain is based on the Active Hydrogen Masers (AHM) that constitutes the source of the GST signals characterized by very good short-term stability. The stability on medium and long terms is ensured by a dedicated function mainly based on a local cesium ensemble and on the TSP data. A second AHM is present as a backup unit, whose output signal is steered to the master one. The Time Transfer function executes time offset measurements of the GST Master Clock (MC) with respect to the UTC (k) labs, the second PTF, and the GPS/USNO time scales. In addition, the GPS to Galileo Time Offset (GGTO) and the PTF1-PTF2 Time Offset products are evaluated.

The GST (MC) signals are provided as a physical reference to the co-located Galileo Sensor Station (not part of the PTF) to provide pseudo-ranging measurements to the GMS Orbit Determination & Time Synchronization functions. GST (MC) time codes are also provided to the Galileo Control Center (GCC) Elements.

PTF functional and architectural schemes are depicted in the following Figures 7 and 8.

The main external control functions are those of the GMS Galileo Asset Control Facility (GACF) for configuration aspects and, for performance aspects, those of the Time Service Provider (TSP) and the Monitoring and Uplink Control Facility (MUCF).

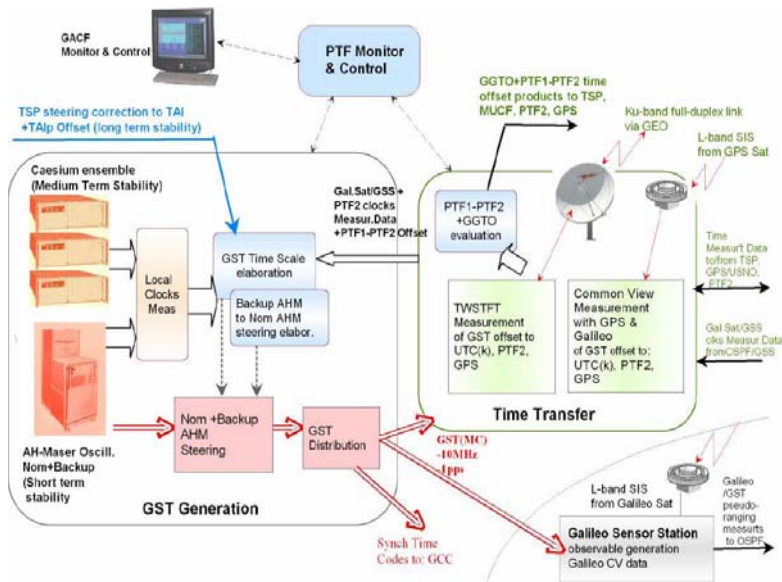

Figure 7. PTF functional block diagram [13].

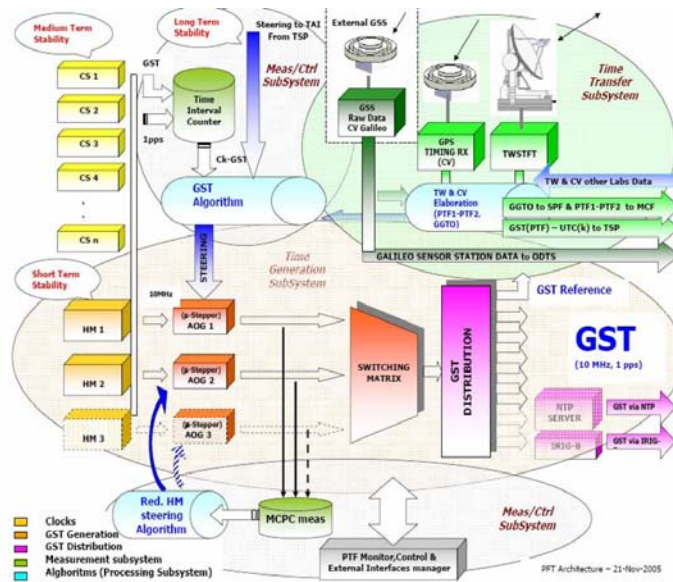

Figure 8. PTF architecture [13].

The PTF Architecture is organized in the following Sub-Systems (S/S):

- Time Generation S/S, including Instruments to generate and distribute GST (MC), i.e. 10 MHz and 1pps, with high dependability, namely the local oscillators, i.e. two Active Hydrogen Masers and four cesium clocks;

- Time Transfer S/S, including TWSTFT Station, CV Rx, OSPF/GSS I/F (to acquire the Galileo onboard and ground “remote” clocks) and the Time Transfer SW to control the such high-accuracy synchronization links;
- Measurement and Control S/S, including Control Computers, Data Network, and Measurement Instrumentation, namely a Time-Interval Counter (TIC) and a Multi-Channel Phase Comparator (MCPC). The SW includes the Algorithms to control the other S/S’s and to monitor the GST performance.

Currently, the PTF is in the Detailed Design Phase. The delivery is foreseen for mid-year 2008 to the “On-Site” Galileo Control Center, i.e. GCC/GMS (Telespazio/Fucino) or GCC/GCS (DLR/Oberpfaffenhofen). Here, the Galileo Segment and System level testing will take place, including also the interface with GPS for interoperability purposes. Afterwards, the Initial Operations Verification phase (IOV), will take place with four Satellites in orbit, and then the Final Operational Configuration Phase (FOC) with 30 Satellites.

The PTF foresees already specific upgrade capabilities for the internal and external resources required for the FOC.

## TIME SERVICE PROVIDER (TSP)

The Fidelity consortium has been under contract since June 2005 for the specification, design, implementation, testing, and operation of a Galileo Time Service Prototype Facility (GTSPF) [14]. The Fidelity consortium comprises a balance of leading industrial companies in the field of navigation and the scientific and technical capabilities of European NMIs, as listed and described in Table 1.

Table 1. Fidelity Team strengths and roles [14].

	Main activity	Role in project
Helios, UK	Technical and management consultancy	Project Manager Lead definition and design
NPL, UK	UK NMI	Lead for GTSP Operational. Contributing to definition and design, GST-TAI prediction and steering algorithms
Kayser-Threde, DE	Design, development & manufacturing in space, scientific and industrial sector	Systems engineering. Contributing to definition and design
CNES, FR	French space agency	GTSP operations.
INRiM, IT	Italian NMI	Standardization, support on algorithms, relation with BIPM
PTB, DE	German NMI.	TWSTFT: operations and link calibration
LNE-SYRTE, FR	French NMI	GPS: operation and receiver calibration
Thales, UK	Global electronics company	Composite clock software
AOS, PL	Polish research institute	Performance assessment

The role of the GTSPF is to deliver time metrology activities to support the In-Orbit Validation (IOV) phase of Galileo. Specifically, it must provide the parameters to steer the Galileo System Time (GST) time scale to Coordinated Universal Time UTC, in order to keep the difference UTC – GST in compliance with requirements [14]. The Fidelity consortium must also manage the relationship with the Bureau International des Poids et Mesures (BIPM). Further, Fidelity has to plan for a smooth transition from the GTSPF at IOV towards the future Full Operational Capability (FOC) of Galileo, together with the potential wider use and role of Galileo timing services. To fulfill its role, the GTSPF prototype has been designed as an automated facility.

The prediction of UTC – GST, a major issue with respect to the requirements of the GTSPF prototype, is based on an algorithm based on clock comparisons between the Galileo Precise Timing Facilities (PTF) and the European National Metrology Institute (NMI) core members of the Fidelity consortium, called the “UTC (k) laboratories” in many documents.

The main role of the GTSPF prototype is to provide parameters for steering GST as realized at the Galileo PTF to UTC (modulo 1 s). This is achieved in a three-step process. First, the GST, as realized in the PTF from an ensemble of atomic clocks (active H-masers, high-performance cesium standards) with dedicated measurement equipment and clock ensemble algorithm, is compared to UTC (k) time scales by Two-Way Satellite Time and Frequency Transfer (TWSTFT) [15] and GPS P3 [16] techniques. Clock and time transfer raw data are sent to the GTSPF for further processing on a daily basis. The Fidelity consortium is responsible for the calibration of the time transfer links [14]. Second, the GTSPF generates a prediction of the difference UTC – GST (modulo 1 s) by means of an intermediate composite clock obtained from the ensemble of H-masers and cesium clocks maintained in the PTFs and in the European NMIs, and using the data of UTC – UTC (k) as computed by the BIPM. The benefits of the composite clock include enhanced stability and integrated integrity monitoring [14]. Third, the GTSPF sends daily steering parameters to the PTF to be used to align the physical realization of GST against UTC (modulo 1 s) as required by the Galileo system specifications [10]. The performance requirements on GST steering which must be met by the GTSPF are: UTC – GST (modulo 1 s) time offset less than 50 ns (coverage factor  $k = 2$ ); uncertainty of the UTC – GST time offset less than 26 ns ( $k = 2$ ); contribution to GST stability due to the GST-to-UTC steering, as computed by GTSPF, less than  $3 \times 10^{-15}$  in terms of Allan deviation at an averaging time of 1 day; uncertainty of the UTC – GST normalized frequency offset less than  $5.4 \times 10^{-14}$  ( $k = 2$ ) at an averaging time of 1 day.

In Figure 9, the context and scope of the GTSPF for Galileo IOV is presented. The central solid rectangle represents the GTSPF specified and designed by Fidelity. This is currently under implementation and testing and will be delivered in time to support Galileo IOV activities. The external entities with which the GTSPF must interface are represented by the other boxes, and are described below. The broad arrows then represent the information flows across the GTSPF external interfaces.

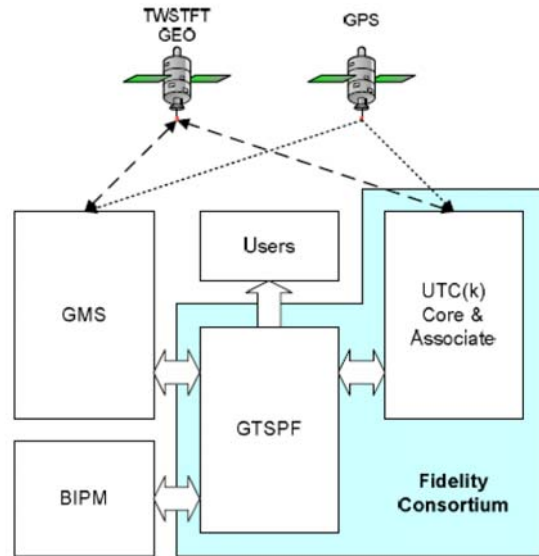

Figure 9. GTSPF Context and scope [14].

The external entities shown in Figure 9, are:

- GMS: The Galileo Ground Mission Segment (GMS) provides the GTSPF with PTF clock and time transfer data on a daily basis, together with the steers actually applied to GST (MC), where MC means “Master clock.” GST (MC) is the physical signal representing GST to which all measurements inside a PTF are referred [14];
- BIPM: provides the GTSPF with its Circular T on a monthly basis, which, among other information, contains in the header of its Section 1 the information regarding the offset between TAI and UTC (integer number of seconds) and scheduled changes of this difference whenever the introduction of a leap second is announced. TAI is the “Temps Atomique International,” computed by the BIPM from about 240 clocks located in about 55 worldwide institutions, from which UTC is built;
- The GTSPF may also provide the BIPM with the PTF clock and time transfer data to be used for the TAI computation and for possible inclusion of the time difference UTC – GST (MC) in the Circular T as per the current practice for GPS and GLONASS time scales. This is currently under discussion;
- UTC (k): The core and associate UTC (k) laboratories provide the GTSPF with individual clock data referenced to UTC (k) and time transfer data on a daily basis. The GTSPF also communicates processing results to individual UTC (k) laboratories;
- Users: The GTSPF provides a Web site including performance reports on GST to TAI steering among other information for authorized parties (e.g., ESA, GSA, Fidelity consortium members, etc).

## ADVANCED ALGORITHMS FOR INTEGRITY (ADVENT)

Integrity demands a rapid and secure anomaly detection in the GNSS. Starting from 2008, INRiM is working on the developing of a clock monitoring algorithm based on the evolution of the Dynamic Allan variance [17]. An example of analysis for clock anomaly detection is reported in Figure 10.

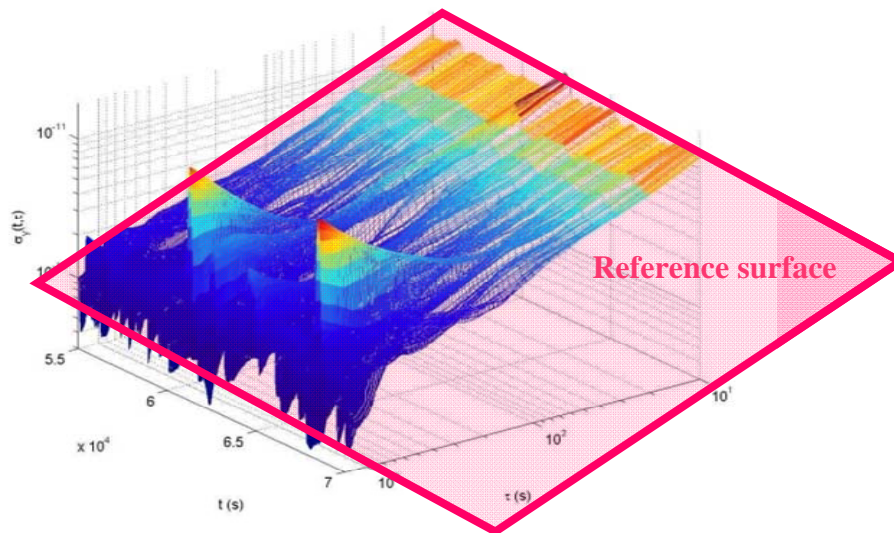

Figure 10. Example of Dynamic Allan variance for clock anomaly detection.

## ACKNOWLEDGMENT

The authors acknowledge the GJU, the European Space Agency (ESA), the Timing Advisory Group, and the industrial companies involved in the current phase of Galileo development for a very fruitful collaboration.

## REFERENCES

- [1] <http://www.INRiM.it>
- [2] F. Cordara, *et al.*, 2004, "The Galileo system test bed V1: first experimental results," in Proceedings of the 18<sup>th</sup> European Frequency and Time Forum (EFTF), 5-7 April 2004, Guildford, UK.
- [3] F. Cordara, R. Costa, L. Lorini, D. Orgiazzi, V. Pettiti, I. Sesia, P. Tavella, P. Elia, M. Mascarello, M. Falcone, and J. Hahn, 2005, "Galileo System Test Bed V1: results on the Experimental Galileo System Time," in Proceedings of the 19th European Frequency and Time Forum (EFTF), 22-24 March 2005, Besançon, France.
- [4] M. Falcone, F. Amarillo-Fernandez, J. Hahn, and H. Favin-Leveque, 2002, "The GALILEO System Test Bed for Early Prototyping and Experimentation of GALILEO Algorithms," in Proceedings of the ION GPS Meeting, 24-27 September 2002, Portland, Oregon, USA (Institute of Navigation, Alexandria, Virginia), pp. 2148-2159.
- [5] M. Falcone, R. Lucas Rodriguez, F. Emma, and J. Hahn, 2001, "The GALILEO System Test Bed (GSTB)," in Proceedings of the GNSS 2001 Conference, 8-11 May 2001, Seville, Spain.

- [6] E. Breeuwer, R. Franco, M. Falcone, J. C. De Mateo, P. Erhard, and N. M. Hollreiser, 2002, “*Simulation and Experimentation in the GALILEO System Design and Verification*,” in Proceedings of the GNSS 2002 Conference, 27-30 May 2002, Copenhagen, Denmark.
- [7] E. Detoma, S. Facinie, M. Gotta, G. Graglia, F. Cordara, L. Lorini, V. Pettiti, P. Tavella, and J. Hahn, 2003, “*The Experimental Precise Timing Station (E-PTS) for the Galileo System Test Bed –VI, Architectural Design and Experimental Goals*,” in Proceedings of the 34<sup>th</sup> Annual Precise Time and Time Interval (PTTI) Systems and Applications Meeting, 3-5 December 2002, Reston, Virginia, USA (U.S. Naval Observatory, Washington, D.C.), pp. 127-138.
- [8] G. Graglia, E. Detoma, F. Cordara, R. Costa, L. Lorini, D. Orgiazzi, V. Pettiti, P. Tavella, and J. Hahn, 2002, “*The Experimental Precise Timing Station and the Galileo System Time generation in the Galileo System Test Bed Phase VI*,” in Proceedings of the GNSS 2002 Conference, 27-30 May 2002, Copenhagen, Denmark.
- [9] S. Facioni, G. Graglia, M. Mascarello, F. Cordara, R. Costa, M. Farina, L. Lorini, D. Orgiazzi, V. Pettiti, I. Sesia, P. Tavella, M. Falcone, J. Hahn, and M. Brunet, 2004, “*The first months of operation for the Experimental Precise Timing Station in the GSTB-VI project*,” in Proceedings of the 8<sup>th</sup> European Navigation Conference (ENC-GNSS 2004), 17-19 May 2004, Rotterdam, The Netherlands.
- [10] I. Hidalgo, R. Piriz, A. Mozo, G. Tobias, P. Tavella, I. Sesia, G. Cerretto, P. Waller, F. Gonzalez, and J. Hahn, 2009, “*Estimation and Prediction of the GIOVE Clocks*,” in Proceedings of the 40<sup>th</sup> Annual Precise Time and Time Interval (PTTI) Systems and Applications Meeting, 1-4 December 2008, Reston, Virginia, USA (U.S. Naval Observatory, Washington, D.C.), pp. 361-374.
- [11] P. Waller, F. Gonzalez, J. Hahn, S. Binda, I. Hidalgo, R. Piriz, A. Mozo, G. Tobias, I. Sesia, P. Tavella, and G. Cerretto, 2009, “*In-Orbit Performance Assessment of GIOVE Clocks*,” in Proceedings of the 40<sup>th</sup> Annual Precise Time and Time Interval (PTTI) Systems and Applications Meeting, 1-4 December 2008, Reston, Virginia, USA (U.S. Naval Observatory, Washington, D.C.), pp. 69-82.
- [12] R. Piriz, A. Mozo, G. Tobias, V. Fernandez, P. Tavella, I. Sesia, G. Cerretto, and J. Hahn, 2008, “*GNSS Interoperability: Offset between reference Time Scales and Timing Biases*,” **Metrologia**, **45**, 87-102.
- [13] R. Zanello, M. Mascarello, L. Galleani, P. Tavella, E. Detoma, and A. Bellotti, “*The Galileo Precise Timing Facility*,” in Proceedings of TimeNav’07, IEEE Frequency Control Symposium (FCS) Joint with the 21<sup>st</sup> European Frequency and Time Forum (EFTF), 29 May-1 June 2007, Geneva, Switzerland (IEEE Publication 07CH37839), pp. 458-462.
- [14] J. Achkar, *et al.*, 2007, “*Fidelity – Progress report on delivering the prototype Galileo time service provider*,” in Proceedings of the 2007 IEEE International Frequency Control Symposium (FCS) Joint with the 21<sup>st</sup> European Frequency and Time Forum (EFTF) – TimeNav’07, 29 May-1 June 2007, Geneva, Switzerland (IEEE Publication 07CH37839), pp. 446-451.
- [15] 2003, “*The operational use of two-way satellite time and frequency transfer employing PN codes*,” **Rec. ITU-R TF.1153-2** (International Telecommunications Union).
- [16] P. Defraigne and G. Petit, 2003, “*Time transfer to TAI using geodetic receivers*,” **Metrologia**, **40**, 184-188.

- [17] L. Galleani and P. Tavella, 2007, “*Characterization of nonstationary atomic clocks,*” **Fluctuation and Noise Letters**, **70**, L461 - L471.