

TWO-WAY TIME TRANSFER TO AIRBORNE PLATFORMS USING COMMERCIAL SATELLITE MODEMS

Tom Celano and Jeremy Warriner, Timing Solutions Corporation
5335 Sterling Drive, Suite B
Boulder, CO 80301, USA
Tel: 303-939-8481; E-mail: tpcelano@timing.com

Scott Francis, Zeta Associates

Al Gifford, National Institute of Standards and Technology

Peter Howe and 1Lt Richard Beckman, U.S. Air Force Research Laboratory

Abstract

Time-based communications (TBC) involves the use of an active data channel for time transfer. TBC was demonstrated in 2000 using commercial SATCOM modems for two-way satellite time transfer between static locations. In 2002, testing was conducted with the Air Force Research Lab (AFRL) at Wright Patterson Air Force Base to demonstrate a TBC implementation from the ground to an airborne platform using standard communications channels and equipment. Algorithms to perform Dynamic Two-Way Time Transfer (DTWTT) have been developed to correct raw time transfer data for platform motion and measurement effects. Flight tests were conducted in November 2002 to demonstrate the algorithms and determine the level of performance that can be expected from dynamic two-way time transfer.

This paper begins with a review of time-based communications followed by the introduction of dynamic two-way time transfer. The flight experiment is presented with a description of the data collection hardware as well as a detailed presentation of the flight data. Conclusions on the use of DTWTT are drawn based on the results of the flight tests.

1.0 TIME-BASED COMMUNICATIONS

Time-based communications is a technology where an active data communications channel is utilized as a vehicle for two-way time transfer. The impetus for the development of this technology is the existence of users with stringent timing requirements and existing or planned communications infrastructures. Time-based communications provides precise time transfer capability in the background of an active data transfer channel (one that is being used for data communication). This allows two ends of a communications link to be precisely synchronized without fielding an independent timing system.

Time-based communications (TBC) is a generic technology with a few basic requirements [1]. Implementation of these concepts has been accomplished over fiber [2] and satellite channels [1,3] with excellent results.

The TBC program goals include a series of incremental demonstrations where each step is progressively more challenging and builds on the success of the previous step. Table 1 shows the TBC program goals and status. The program began with a short-baseline fiber implementation in 1996 [2]. Recent milestones include a 100-mile fiber implementation and a trans-Atlantic SATCOM implementation [3]. In each case, a standard communications protocol is used to demonstrate the technology. For the fiber case, the SONET protocol is used and for the satellite case a coded, scrambled, QPSK signal from a commercial SATCOM modem is used.

Table 1. TBC Program Goals.

Scenario	Implementation/Status	Future Plans
Gnd-to-Gnd (short baseline)	SONET point-to-point implementation. 17 ps performance	Network implementation through add/drop Mux's
Gnd-to-Gnd (long baseline)	SATCOM Relay using commercial modems	TDMA implementation to serve clients from a central site
Gnd-to-Air	LOS and SATCOM cases using commercial modems and new algorithms for platform dynamics	Flight Tests in 2002 and 2003 in coordination with AFRL.
Gnd-to-Space	Implementation using ITT Low Power Transceiver (LPT) in design stage	LPT development w/AFRL and NASA. Space demo on Space Shuttle and/or Space Station
Space-to-Space	Preliminary development	LPT platform as demonstration

This paper presents the results from the first dynamic implementation of TBC using a ground-to-air SATCOM implementation. Flight tests were performed in November 2002 using an AFRL RC-135E aircraft operating out of Wright Patterson Air Force Base.

2.0 DYNAMIC TWO-WAY TIME TRANSFER

Dynamic two-way time transfer (DTWTT) involves exchanging time between two locations where one or both of them may be moving. This section details the two-way time transfer equations for the static and the dynamic case.

2.1 STATIC TWO-WAY TIME TRANSFER

Two-way time transfer has been used for years over satellite links between static locations. Each location simultaneously transmits a time code through a satellite communications channel. The time between the

two clocks is determined by combining the measurements made at each end of the link. When performed using a geosynchronous satellite as the relay, the propagation delay from one side to the other is determined by the range from each transmitter through the transponder and then down to the receiver. In order for this delay to cancel sufficiently to measure the relative clock offset, the propagation delay difference between the two paths must be small. This translates to a requirement that the radial satellite motion (to each transmitter/receiver pair) must be minimal over the measurement interval. For the case of two static nodes on the earth communicating through a geosynchronous satellite, this is true to the sub-nanosecond level for simultaneous transmission (simultaneity need only be maintained at tens of microseconds for standard orbits) [4]. The propagation delay of the satellite communications channel cancels and the measurement need only be adjusted for measurement effects and differences in equipment delay.

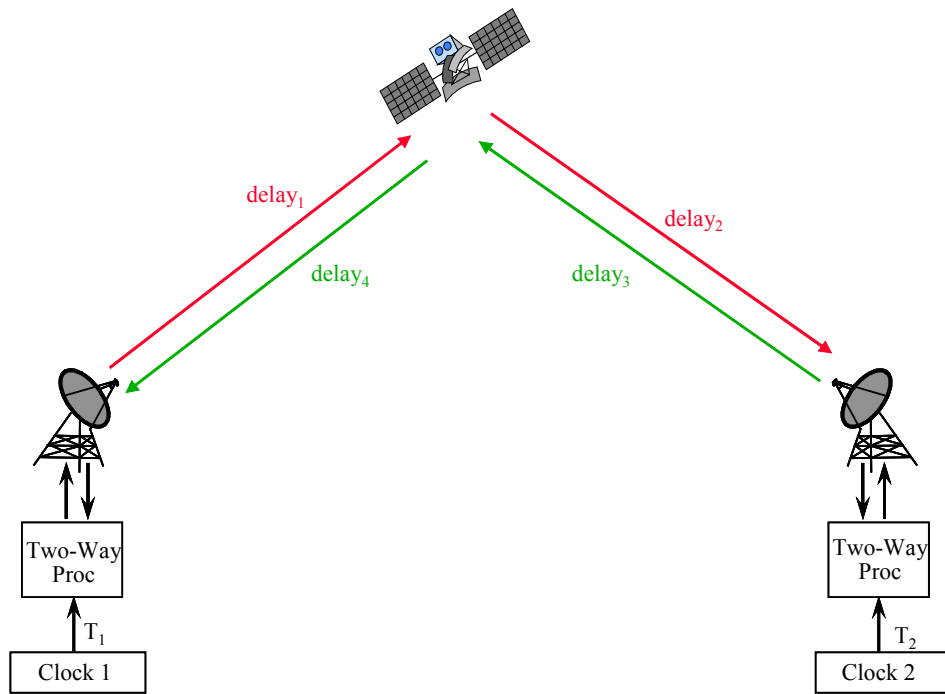

Figure 1. Static Two-Way Time Transfer.

The two-way equations for the static case involve two measurements (made at each side of the link) between two clocks. The measurement configuration for the static two-way calculation (satellite relay case) is depicted in Figure 1. The measurements that are made by the two-way processor at each end of the link are:

$$\text{Meas}_1 = T_1 - (T_2 + \text{delay}_3 + \text{delay}_4 + \text{Sagnac}_{12}) \quad (1)$$

$$\text{Meas}_2 = T_2 - (T_1 + \text{delay}_1 + \text{delay}_2 + \text{Sagnac}_{21}) \quad (2)$$

where:

T_1 = Time of clock 1

T_2 = Time of clock 2

delay_1 = delay from Clock 1 site to satellite during time of transmission

delay_2 = delay from satellite to Clock 2 site during time of transmission
 delay_3 = delay from Clock 2 site to satellite during time of transmission
 delay_4 = delay from satellite to Clock 1 site during time of transmission
 Sagnac_{12} = Sagnac time-of-flight correction from node 1 to node 2, and
 Sagnac_{21} = Sagnac time-of-flight correction from node 2 to node 1.

Subtracting (1) from (2) yields

$$\text{Meas}_2 - \text{Meas}_1 = 2*(T_2 - T_1) + (\text{delay}_1 - \text{delay}_4) + (\text{delay}_2 - \text{delay}_3) + \Delta\text{Sagnac} \quad (3)$$

where:

$$\Delta\text{Sagnac} = \text{Sagnac}_{21} - \text{Sagnac}_{12}$$

and

$$T_2 - T_1 = .5*[(\text{Meas}_2 - \text{Meas}_1) - (\text{delay}_1 - \text{delay}_4) - (\text{delay}_2 - \text{delay}_3) + \Delta\text{Sagnac}] \quad (4)$$

In the case of static time transfer, $\text{delay}_1 \approx \text{delay}_4$ and $\text{delay}_2 \approx \text{delay}_3$ over the measurement interval. In this case, (4) reduces to

$$T_2 - T_1 = .5*[(\text{Meas}_2 - \text{Meas}_1) + \Delta\text{Sagnac}]. \quad (5)$$

For the static case, ΔSagnac is a constant.

2.2 DTWTT CALCULATION

Dynamic two-way time transfer involves performing the same measurement depicted in Section 2.1 between two nodes where one (or both) may be moving. Figure 2 depicts a measurement scenario where a satellite channel is used between a ground node and an airborne node. This case is identical to the static case of Figure 1, except one of the nodes is now moving over the measurement interval. The addition of platform motion changes the computation of the two-way clock difference.

For the dynamic case, the cancellations in equation (3) cannot be assumed. For the example shown in Figure 3, $\text{delay}_1 \approx \text{delay}_4$, but $\text{delay}_2 \neq \text{delay}_3$ over the measurement interval. This is because over the 0.25 second between transmitting a signal and receiving the signal from clock 1, the platform containing clock 2 has moved and the radial delay from to the satellite has changed. In addition, the Sagnac term for the moving platform becomes time-varying based on the change in location of the platform.

The dynamic case can be represented as

$$T_2 - T_1 = .5*[(\text{Meas}_2 - \text{Meas}_1) + \Delta\text{prop_delay} + \Delta\text{Sagnac}]. \quad (6)$$

where:

$\Delta\text{prop_delay}$ = change in the propagation delay over the measurement interval.

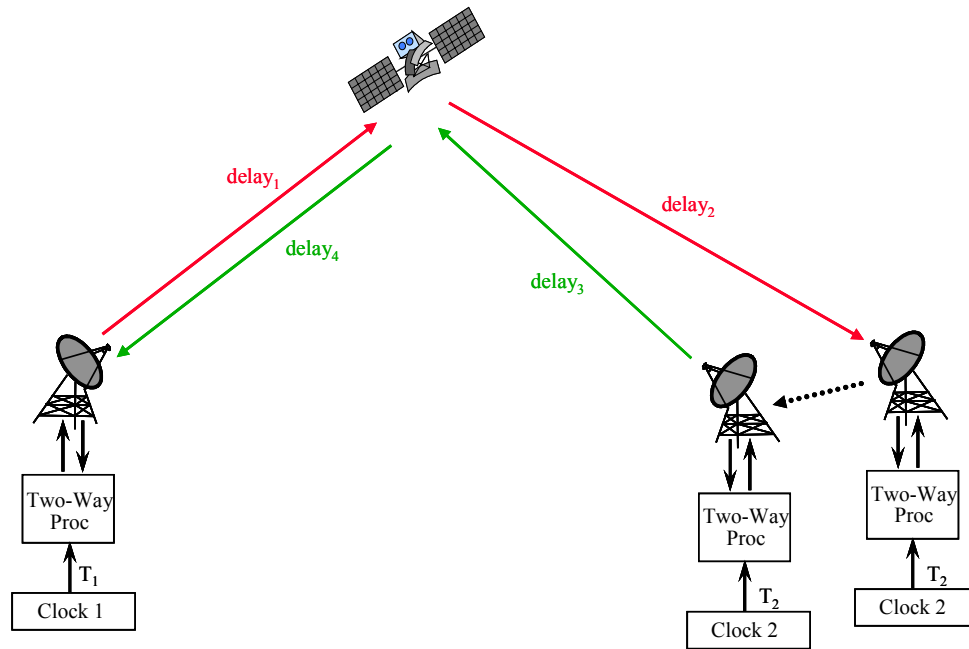

Figure 2. Dynamic Two-Way Time Transfer Configuration.

The Δ_{prop_delay} is a time varying value that solely depends on the relative platform motion during the measurement interval. The Δ_{Sagnac} term is a time-varying value that depends on the absolute position of the two platforms on the earth. The next section shows the magnitude of these effects for an airborne platform.

2.3 MEASUREMENT EFFECTS VS. CLOCK EFFECTS

When a clock is in motion and being measured using two-way time transfer, there are multiple effects that alter the performance of the clock and the fidelity of the measurement. This section presents the difference between clock effects and measurement effects and how they are handled in DTWTT.

The goal of DTWTT is to measure the relative phase offset between two clocks where one or both may be in motion. There are multiple effects that change the frequency of a clock in motion. For this presentation, these are all grouped into a category called *clock effects*. Clock effects include gravitational potential, velocity and Sagnac effects [5] and depend on altitude, speed, and/or direction. Each of these clock effects acts on the physical clock, altering its performance from its static state. While these effects are interesting, they are not corrected in the DTWTT measurement. The goal of DTWTT is to measure the offset of the clocks, and the clock effects merely make the origin of the offset more complex. The fact that one or both of the clocks is running faster or slower due to relativistic effects will be measured using the two-way calculation and can be compensated by the user of the two-way data.

Effects that are of concern to the measurement are Δ_{prop_delay} and Δ_{Sagnac} from (6). Note that the Δ_{Sagnac} term is a time-of-flight term from the propagation of the transmitted signal from each two-way terminal and not the relativistic effect listed in the clock effects above. Each of these *measurement effects* is a function of the motion of a platform and, if not corrected, will cause the two-way calculation to be compromised. These measurement effects are a direct result of the two-way measurement that is being made using a moving platform.

3.0 FLIGHT TESTS

Flight tests were conducted at Wright Patterson Air Force Base (WPAFB) in November 2002 using an RC-135 aircraft operated by the Air Force Research Lab (AFRL). The RC-135 (seen in Figure 3) is an airborne testbed that provides a laboratory environment supporting airborne terminal developments, on-orbit satellite evaluations, dynamic pointing and tracking algorithms, antenna and radome flight test, communications protocol validation, performance anomaly identification, and interoperability tests. For the dynamic two-way time transfer tests, equipment was installed in the aircraft and on the ground to make the timing measurements. The aircraft includes a Ku-band satellite terminal in a radome on the top of the aircraft as well as other antennas for GPS collection, L-Band links, and other applications.



Figure 3. AFRL RC-135 Aircraft.

Identical DTWTT equipment was installed on the aircraft and the ground (Figure 4). Each hardware suite included RF equipment (dish and transceiver) as well as two-way equipment (modem, measurement chassis, and cesium). The RF ground equipment was standard commercial hardware and the RF equipment on the aircraft was a custom terminal built for flight use. The modems were commercial satellite communications units that have been modified to provide two-way measurements in the background of standard data transmission. The measurement chassis, seen in Figure 5, consisted of precision timing equipment including two-channel timers, amplifiers, and a controlling computer. The computer was used to control the measurement collection and process the two-way measurements. The aircraft also includes multiple measurement devices (GPS and INS) to determine its location during flight.

The following sections detail the data collected during a flight test where a Ku-band communications channel was used between the ground and the aircraft. A commercial satellite was used to create a data channel with 768 kbps user data rate and Viterbi $\frac{1}{2}$ coding. The timing data are detailed in the next section.

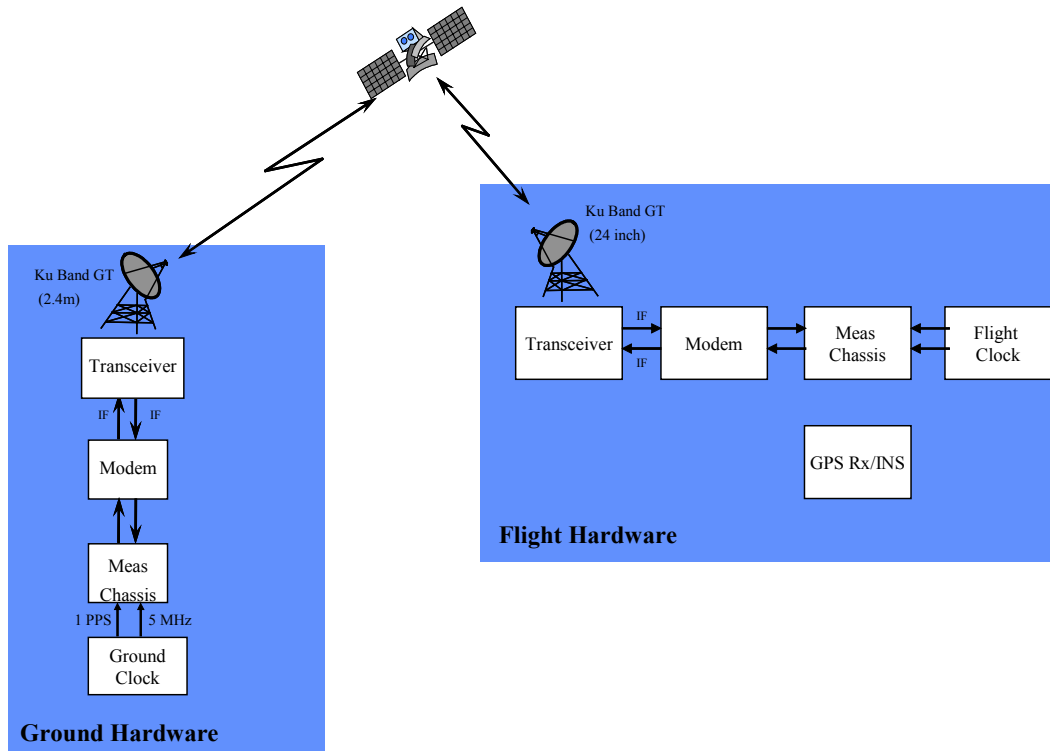

Figure 4. Hardware Configuration.

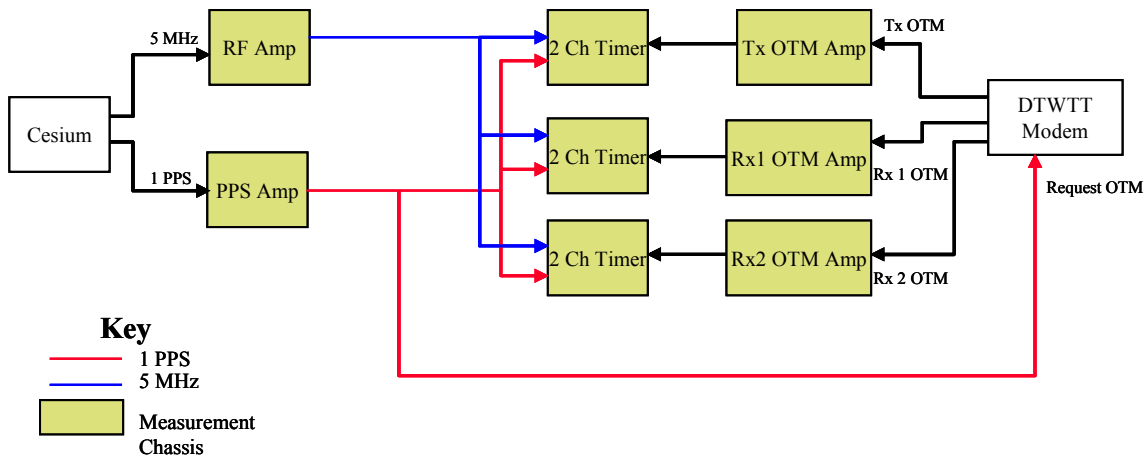

Figure 5. Measurement Chassis Hardware.

3.1 FLIGHT DATA

The collection of flight data was planned to provide the best method to verify flight measurements and combine them with ground measurements to create a record of the relative performance of two cesium clocks. The clocks were measured before and after the flight to establish the drift rate and phase

relationship between the 1 PPS signals. One of the clocks was then taken to the aircraft where it was measured during flight using DTWTT. After the flight, the clock was removed from the aircraft and returned to the ground measurement system, where measurements against the ground clock were resumed. Power was maintained on the flight clock at all times (either AC or battery).

The data record for the flight consists of the following plots:

- 1) Clock difference data before and after the flight
- 2) Lat/Lon plot of flight path
- 3) Range Rate of flight path (toward satellite)
- 4) Raw two-way data taken during flight
- 5) Corrections to two-way data (based on platform motion and change in Sagnac)
- 6) Corrected two-way data
- 7) Clock difference data with two-way data showing the trend during flight.

The data set begin in Figure 6 with the clock difference record between the ground clock and the flight clock. The clocks were measured using a two-channel timer using equal length cables. The gap in the middle of the data set is the period of time when the clocks were not co-located (because the flight clock was on the airplane).

After loading the flight clock into the aircraft, the plane took off and flew for four hours. Figure 7 shows the path of the aircraft during the flight. The aircraft flew a cross pattern in order to maximize the range rate during the north/south paths and minimize the range rate during the east/west paths. The DTWTT corrections should be maximized when the aircraft is flying directly toward or away from the satellite (max range rate) and should be minimized when the aircraft is flying tangential to the satellite (min range rate). Figure 8 shows the range, range rate, and range acceleration for the 4-hour flight.

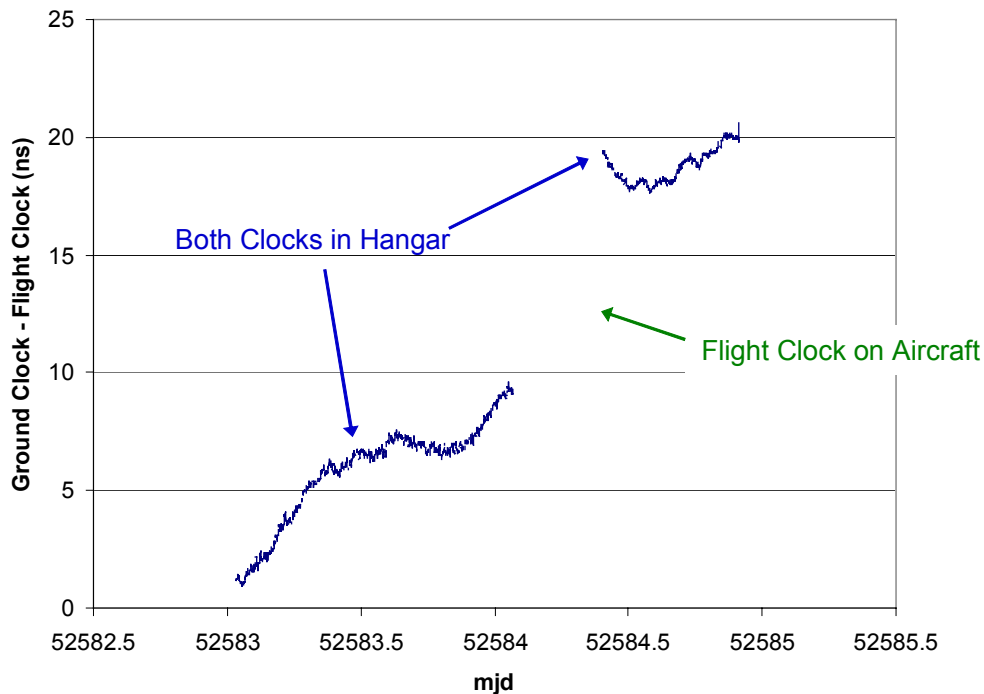

Figure 6. Clock Difference Data Before and After Flight 1.

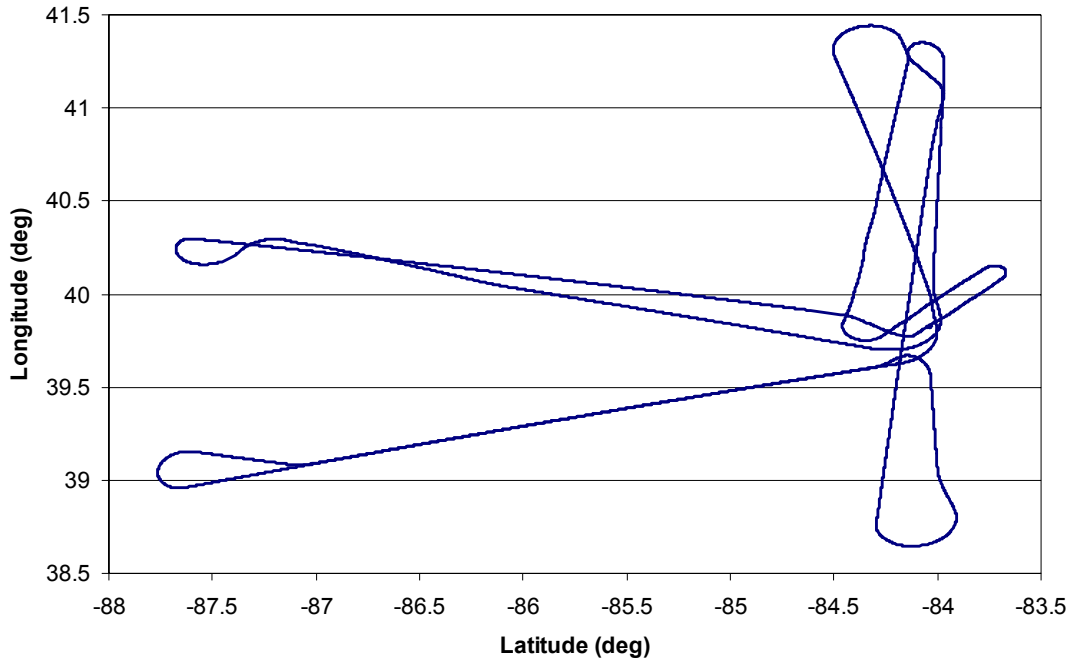

Figure 7. Flight Path.

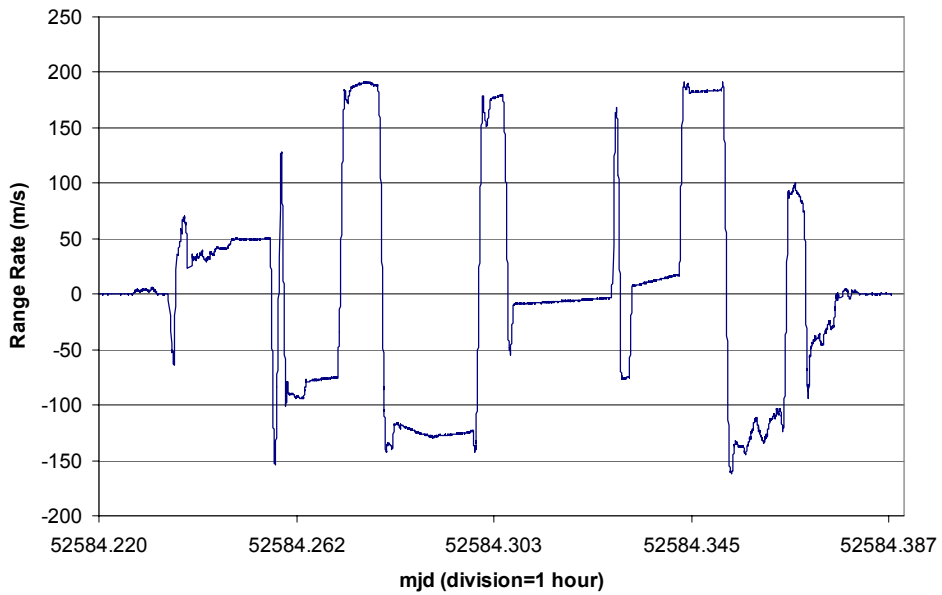

Figure 8. Range Rate between Plane and Satellite.

The raw two-way time transfer data are seen in Figure 9. Data were taken once a second. The raw two-way data are flat with an rms of approximately 6 ns during portions of the flight when the heading is constant. The raw two-way data steps to new values when the velocity vector changes. Comparing the data in Figure 9 with the data in Figure 8 shows a direct correlation between the shape of the raw data and

the range rate. This demonstrates that the motion of the aircraft had a profound effect on the uncorrected data.

In order to correct the data in Figure 9, the $\Delta\text{prop_delay}$ and ΔSagnac from (6) must be calculated and removed. Figure 10 shows the two corrections on the same plot. The $\Delta\text{prop_delay}$ is by far the dominant effect, but both must be removed in order to achieve a quality measurement. Figure 11 is a plot of the corrected data. The corrected data have been averaged over a sliding 30-second window. The precision of the data after averaging is < 1 ns.

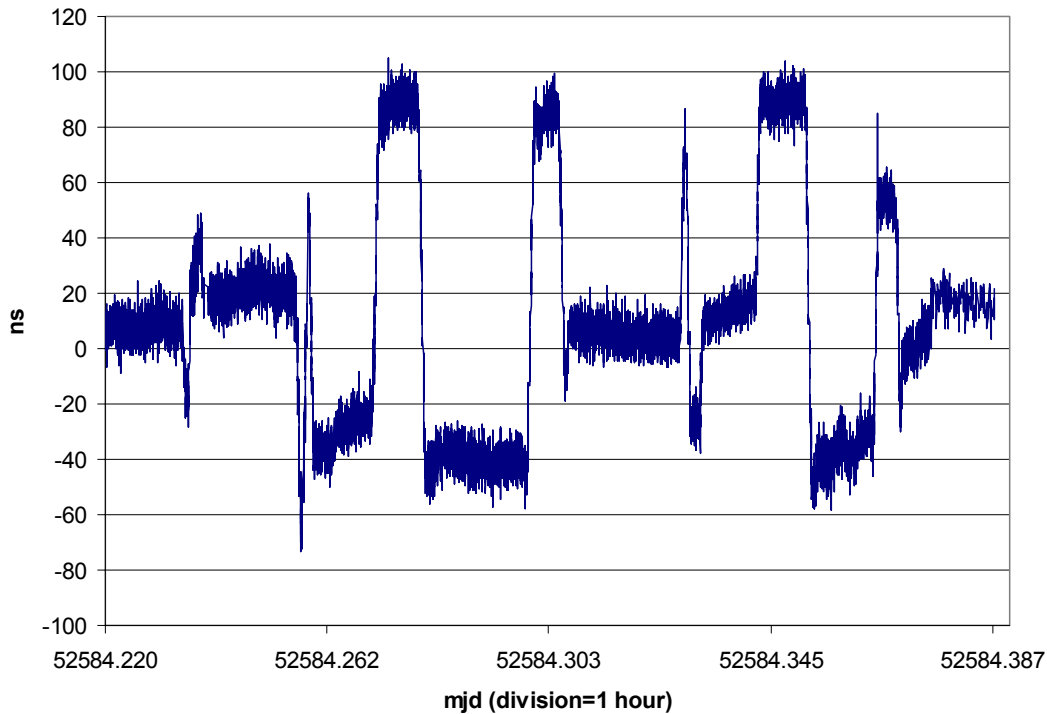

Figure 9. Raw Two-Way Data.

The final evaluation of the data is dependent on how well the measured data connect the two clock difference sets seen in Figure 6. This is seen in Figure 12, where the flight data are plotted on the same curve as the clock difference data collected on the ground before and after the flight. The flight data fill in the missing section well and provide a sub-nanosecond measurement of the relative clock offset during flight.

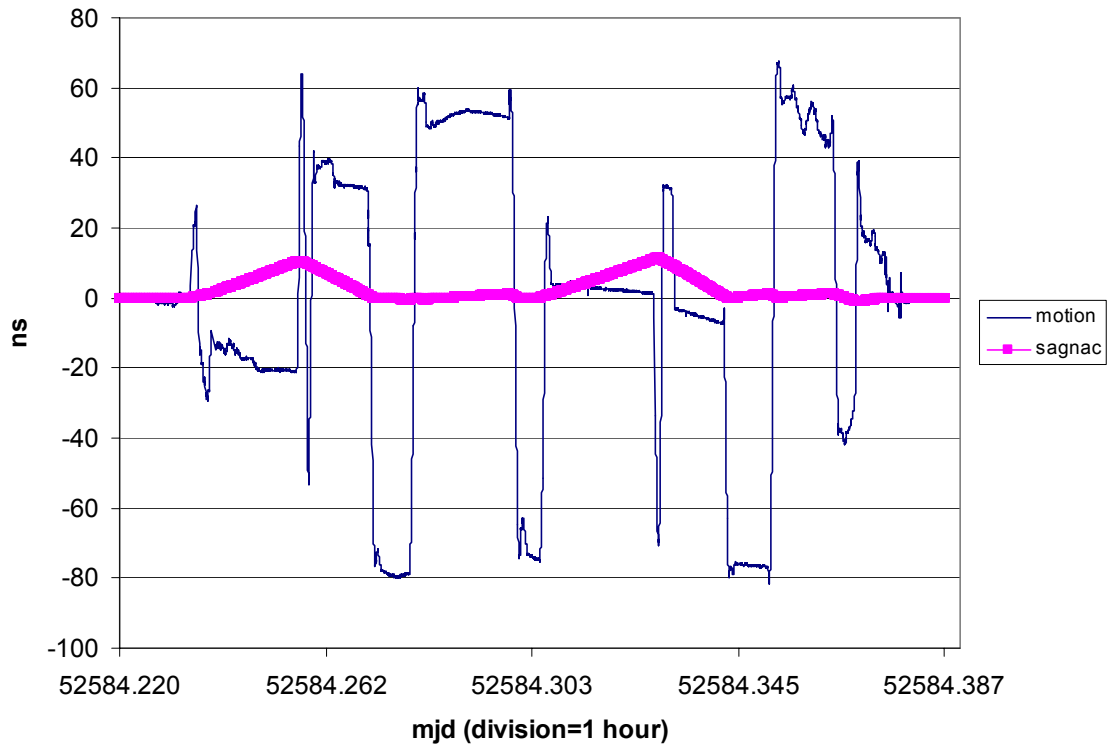

Figure 10. Corrections to Two-Way Data.

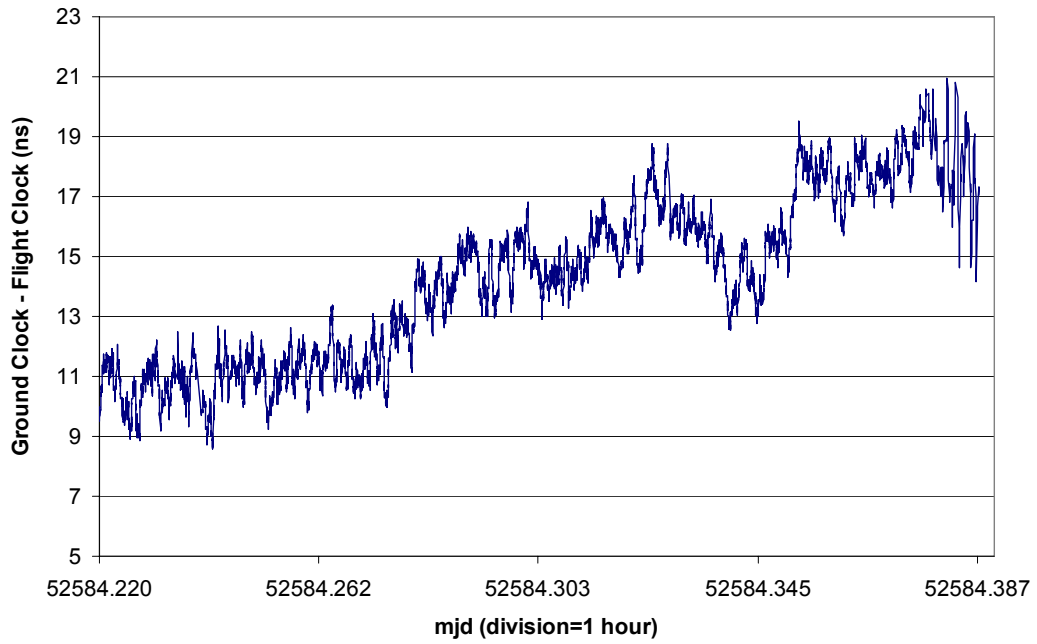

Figure 11. Corrected Two-Way Data (60-second average).

4.0 CONCLUSIONS

Time-based communications has been extended to the dynamic case to enable two-way time transfer between platforms in motion. The concepts of dynamic two-way time transfer have been introduced and demonstrated using an AFRL aircraft. Data were presented that shows that measurements can be made in flight to determine the clock difference between a ground clock and a flight clock to below 1 ns (rms on a 30-second average). Additional data sets were collected and will be presented in future publications. These data sets include line-of-sight links (no satellite relay), as well as higher data rate channels that provide better instantaneous measurement precision.

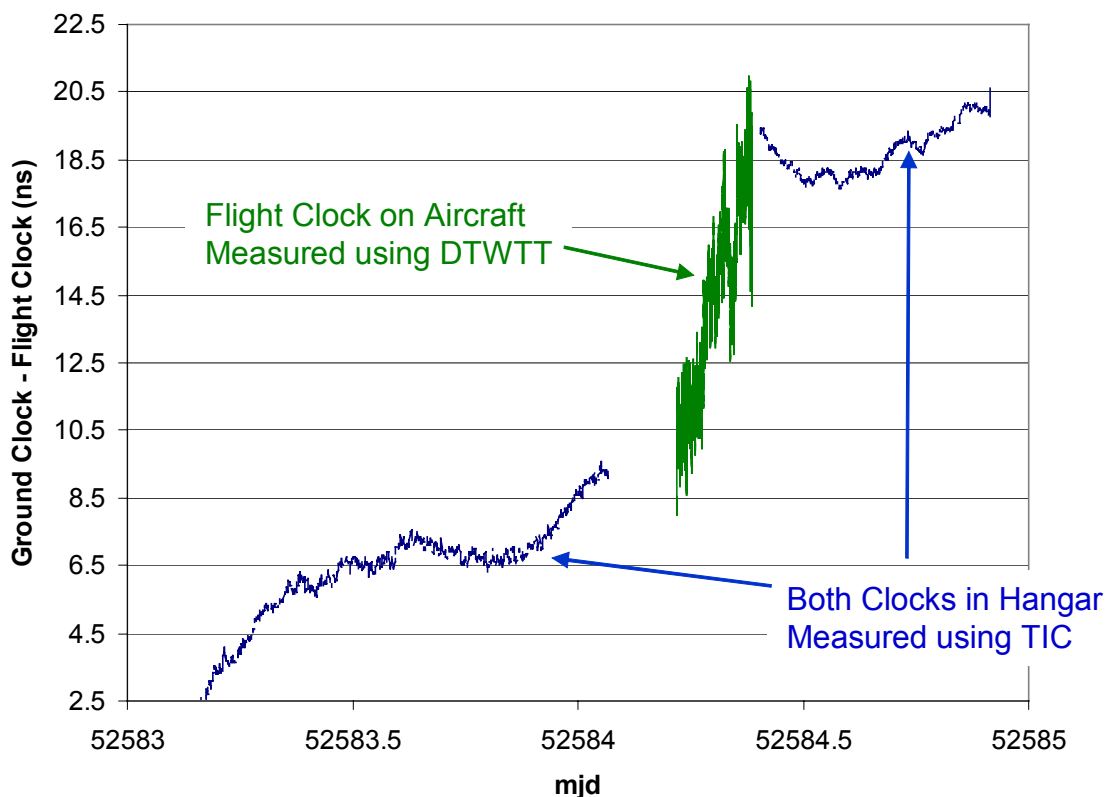

Figure 12. Clock Difference Data and Flight Data.

5.0 REFERENCES

- [1] T. P. Celano, S. P. Francis, and G. A. Gifford, 2000, "Continuous Satellite Two-Way Time Transfer Using Commercial Modems," in Proceedings of the 2000 IEEE/EIA International Frequency Control Symposium & Exhibition, 7-9 June 2000, Kansas City, Missouri, USA (IEEE Publication 00CH37052), pp 607-611.
- [2] M. Calhoun, P. Kuhnle, R. Sydnor, S. Stein, and A. Gifford, 1997, "Precision Time and Frequency Transfer Utilizing SONENT OC-3," in Proceedings of the 28th Precise Time and Time Interval (PTTI) Meeting, 3-5 December 1996, Reston, Virginia, USA (U.S. Naval Observatory, Washington, D.C.), pp. 339-348.

- [3] T. P. Celano, S. P. Francis, G. A. Gifford, B. J. Ramsey, and T. L. Erickson, 2001, “*Results of a Continuous Transatlantic Two-Way Satellite Time Transfer Test Using Commercial Modems*,” in Proceedings of the 32nd Precise Time and Time Interval (PTTI) Meeting, 28-30 November 2000, Reston, Virginia, USA (U.S. Naval Observatory, Washington, D.C.), pp. 211-219.
- [4] D. W. Hanson, 1989, “*Fundamentals of Two-Way Time Transfers by Satellite*,” in Proceedings of the 43rd Annual Symposium on Frequency Control, 31 May-2 June 1989, Denver, Colorado, USA (IEEE Publication 89CH2690-6), pp. 174-178.
- [5] R. A. Nelson, 2002, **Handbook on Relativistic Time Transfer**.

QUESTIONS AND ANSWERS

DAVE HOWE (National Institute of Standards and Technology): Excellent presentation. This is a marvelous result. How did you get the range rate data?

TOM CELANO: We had a GPS receiver on the aircraft. We solved for the position of the aircraft, and the satellite is pretty much stationary. So it is just a matter of computing the radial distance between the two.

HOWE: Second question is multi-path. Did you have any experience with that?

CELANO: In this scenario, no, Dave. We are talking about a KU-band satellite terminal dish where we have directional dishes. So we had a 2.4-meter dish on the ground, and a 2-foot dish on the aircraft, and we did not see any issues with multi-path.

I cannot say the same for our line-of-site stuff, where we had a Yagi antenna on the ground and a blade on the aircraft. And it is rampant with multi-path effects; you will see a lot of that at Frequency Control. But when you have directional dishes like this and you are doing a satellite link, it's much, much less of an issue.