

FIBER OPTIC REFERENCE FREQUENCY DISTRIBUTION TO REMOTE BEAM WAVEGUIDE ANTENNAS*

MALCOLM CALHOUN, PAUL KUHNLE, and JULIUS LAW
Jet Propulsion Laboratory
California Institute of Technology
Pasadena, California 91109

Abstract

In the NASA/JPL Deep Space Network (DSN), radio science experiments (probing outer planet atmospheres, rings, gravitational waves, etc.) and very long-base interferometry (VLBI) require ultra-stable, low phase noise reference frequency signals at the user locations. Typical locations for radio science/VLBI exciters and down-converters are the cone areas of the 34 m high efficiency antennas or the 70 m antennas, located several hundred meters from the reference frequency standards. Over the past three years, fiber optic distribution links have replaced coaxial cable distribution for reference frequencies to these antenna sites. Optical fibers are the preferred medium for distribution because of their low attenuation, immunity to EMI/RFI, and temperature stability. A new network of Beam Waveguide (BWG) antennas presently under construction in the DSN requires hydrogen maser stability at tens of kilometers distance from the frequency standards central location. The topic of this paper is the design and implementation of an optical fiber distribution link which provides ultra-stable reference frequencies to users at a remote BWG antenna.

The temperature profile from the earth's surface to a depth of six feet over a time period of six months was used to optimize the placement of the fiber optic cables. In-situ evaluation of the fiber optic link performance indicates Allan deviation on the order of parts in 10^{-15} at 1000 and 10,000 seconds averaging time; thus, the link stability degradation due to environmental conditions still preserves hydrogen maser stability at the user locations. This paper reports on the implementation of optical fibers and electro-optic devices for distributing very stable, low phase noise reference signals to remote BWG antenna locations. Allan deviation and phase noise test results for a 16 km fiber optic distribution link are presented in the paper.

INTRODUCTION

The NASA/JPL Deep Space Network is expanding its spacecraft tracking capability with a network of 34 meter Beam Waveguide antennas. A cluster of three of these antennas at the Goldstone Tracking Station (GTS) is located a distance of 16 kilometers from the Signal

*The research described in this paper was carried out at the Jet Propulsion Laboratory, California Institute of Technology, under a contract sponsored by the National Aeronautics and Space Administration.

Processing Center (SPC). Deep Space Station 24 (DSS 24), the first of the cluster to be completed is scheduled to go on-line in late 1994. In support of antenna tracking functions as well as radio science and VLBI experiments, precise time and stable reference frequency is required at this remote antenna site. The Frequency and Timing Systems Engineering Group at JPL is responsible for providing reference frequency and precise time to users at the antenna. Certain applications at the antenna require frequency stability and phase noise of the quality of a hydrogen maser. Since the hydrogen maser frequency standard is located at the SPC, the problem becomes one of distributing the signals to remote locations without signal degradation.

The distance between the SPC and the antennas is too great to consider coaxial cable for the reference frequency and time signals; also, microwave links do not provide the required stability. The method of choice for the distribution implementation is fiber optic links. Due to cost constraints, commercial off-the-shelf equipment was utilized as much as possible. The optical fibers in the link are standard, single mode SMF-28, 96 fibers contained in a direct burial cable. The burial depth is approximately 1.5 meters.

The hardware implementation for timing and reference frequency along with tests results measured after the installation was completed are presented in this paper. Also, stability considerations based on temperature effects on the optical fibers are discussed.

DISTRIBUTION HARDWARE

The 5 MHz reference frequency signal and the modified IRIG-G time code signals are transmitted over separate fiber optic links to avoid corruption of the reference signal. The terminal equipment for the fiber links is the Wavelink model 3290 manufactured by the Grass Valley Group, a subsidiary of Tektronix, Inc. The transmitter consists of a 1300 nm laser diode along with the required bias and modulation circuits. The receiver contains a photodetector for converting the 1300 nm light to RF which is demodulated to recover the signal. In order to meet the phase noise requirements for radio science applications, the 5 MHz reference frequency recovered from the optical receiver is phase locked by a FTS 1050 Disciplined Frequency Standard (DFS) with a 1 Hz loop bandwidth. The signal from the DFS is then distributed to the antenna users. A block diagram of the frequency and timing distribution is shown in Figure 1.

The filtered 5 MHz from the disciplined frequency standard is applied to a distribution assembly where it is multiplied to 10 MHz and to 100 MHz for users who require these frequencies. The distribution assembly employs low noise, high isolation amplifiers. The entire assembly is temperature controlled for improved stability.

The modified IRIG-G time code signal utilizes a 100 KHz carrier frequency. The source signal is derived from the Time Insertion Distribution Assembly at the SPC, applied to the laser transmitter, and recovered at the fiber optic receiver in the antenna pedestal room. A travelling clock was used to set the time at the remote antenna; the time offset between DSS 24 and the SPC is less than 100 nanoseconds. Approximately 82 microseconds time delay was removed at the Time Code Translator because of the 16 km of optical fiber.

TEMPERATURE EFFECTS ON STABILITY

The cables which distribute the reference signals to the remote antennas are buried at a depth of approximately 1.5 meters. This burial depth is sufficient to mitigate the effects of large diurnal temperature variations; however, seasonal changes and weather fronts can still be sensed even at a depth of 2 meters. Figure 2 is a plot of surface temperature variations at Goldstone Tracking Station, which is located in the California Mojave desert^[1]. Temperatures were recorded at four hour intervals for the period 11 June 1992 to 14 June 1992. Observe the extremes from a low near 12°C to a high near 55°C, with an average T of 35°C per 12 hour interval.

The 1.5 meter burial depth was determined by observing the temperature profile of the earth in the Mojave desert for several months^[1]. Thermocouples were buried at depths of 0.6, 0.9, 1.2, 1.5, and 1.8 meters, respectively. A data logger with a computer was used to record these data. The results of the measurements are shown in Figure 3. Measurements were begun on 14 January 1992 and terminated on 26 June 1992. Analysis of the data indicates that a burial depth of 1.5 meters is sufficient to attenuate the short term temperature variations. In Figure 3, the line with the larger variations is the daily average surface temperature.

The thermal coefficient of delay for the optical fiber is approximately 7 ppm/°C. The length of buried cable is 16 km. At a depth of 1.5 meters, a peak to peak temperature variation of 35°C is reduced to less than 0.1°C, peak to peak. The phase variations due to temperature effects may be calculated as follows:

$$\begin{aligned}\Delta\phi &= \Delta L \times 360^\circ / \lambda_o \\ \Delta L &= Lk\Delta T\end{aligned}$$

where $\Delta\phi$ is the change in phase delay introduced by the temperature variation T , k is the thermal coefficient of delay of the fiber in ppm/°C, L is the optical fiber length in meters, and λ_o is the wavelength of the reference signal in the medium. At a measurement frequency of 100 MHz, the wavelength in the fiber is 2.1 meters. Calculating the phase change for a 35°C surface excursion and a worst case 0.1°C peak to peak at the fiber yields 1.92° phase change at 100 MHz for the 16 km fiber link. This calculated value of $\Delta\phi$ is compared with test results in the next section of this paper.

STABILITY AND PHASE NOISE TEST RESULTS

Since there is no reference signal at the remote antenna site to compare the fiber optic distributed signal, the scheme shown in Figure 4 was used to measure the stability of the reference signal. The 5 MHz signal from the DFS was applied to the Reference Frequency Distribution Assembly where it is multiplied to 10 MHz and to 100 MHz. The 100 MHz output from this assembly was applied to the transmitter of a Fiber Optic Reference Frequency Distribution Assembly (FODA) which is known to have stability and phase noise performance an order of magnitude lower than a hydrogen maser^[2]. The signal was then returned to the

SPC over a test fiber in the same cable bundle that was used to send the reference signal to DSS 24. Figure 5 shows the stability test results using the configuration shown in Figure 4. The Allan deviation shown in Figure 5 was taken with a temporary fiber optic cable to complete the cable run to DSS 24 before the installation was completed. Approximately 420 meters of fiber cable was exposed at the surface of the Mojave desert during these measurements. The temporary cable failed to meet system requirements. Figure 6 shows the change in phase delay as a function of time. The temporary fiber cable caused a change in time delay of approximately 14° per 12 hour period at 100 MHz. The corresponding Allan deviation at the half-day period is 1.5×10^{-14} which does not meet the system requirements.

Figure 7 shows the results of the stability test after the installation of the permanent fiber optic cable. The test results shown are for a fiber optic cable buried at approximately 1.5 meters, with a total length of 16 km. Note that the Allan deviation is well below the specification limits with the exception of $\tau = 1$. This stability anomaly is believed due to the DFS which has a loop bandwidth of less than 1 Hz and a slight overshoot at 1 Hz. The change in phase delay over the fiber optic link is shown in Figure 8. The results indicate a peak-to-peak time variation (at 100 MHz) of approximately 110 picoseconds, which equates to 1.98^{circ} (for 16 km) per 12 hour interval, almost an order of magnitude improvement over the temporary fiber installation. Using the

$\Delta\phi$ equation from the previous section yields a calculated value of 1.92° per 12 hour interval, which closely agrees with the measured phase delay. Observe in Figure 7 that the Allan deviation value at the half-day interval is approximately 1.5×10^{-15} , which is an order of magnitude better than the temporary fiber and also meets the system requirement for long term stability.

Phase noise tests at DSS 24 were run using the test configuration shown in Figure 9. The test system included a high quality test oscillator which was phase locked to the distributed reference signals. Test results are summarized in Table 1.

Table 1. SPC 10 to DSS 24 Phase Noise Test Results

PHASE NOISE TEST RESULTS AT DSS 24				
FREQUENCY OFFSET FROM CARRIER (Hz)	ESTIMATED PERFORMANCE AT X BAND: FROM D-LEVEL REVIEW 12-17-92 (dBc)	MEASURED AT 5 MHz (dBc)	MEASURED AT 100 MHz (dBc)	EQUIVALENT AT X-BAND ($\mathcal{L}(f)$ 5 MHz -64 dB) (dBc)
1	-52	-121	-96	-57
10	-66	-140	-115	-76
100	-77	-148	-123	-84
1000	-77	-150	-125	-86
10000	-77	-151	-125	-87
100000	-77	-154	-126	-90

TIMING DISTRIBUTION

The timing distribution signal for DSS 24 is obtained from the master clock at SPC 10. The signal is a modified IRIG-G time code which is derived from the Time Insertion Distribution Assembly (TIDS) at SPC 10. The signal flow from the source to the remote antenna is shown in Figure 1. In order to have the time offset at DSS 24 within the required 1 microsecond of the SPC 10 master clock, a travelling Cesium Clock was used to determine and remove the time delay over the 16 km fiber optic cable. Approximately 82 microseconds of time delay was removed by a special Time Code Translator (TCT) at the remote antenna. Consequently, the remote clock at DSS 24 is within 50 nanoseconds of the SPC 10 clock and the measured jitter at the antenna is less than 2 nanoseconds.

CONCLUSIONS

The fiber optic reference frequency and timing distribution from SPC 10 to DSS 24 is complete. Testing was begun with a temporary fiber optic cable with 420 meters exposed to the desert extremes of hot and cold temperatures. Test results did not meet system requirements, and thus were delayed until a permanent, buried fiber cable was installed. Test results with the 16 km of buried cable indicate that the system phase noise performance meets requirements with some margin. The stability of the reference signals is within system requirements except at $\tau = 1$, where the commercial fiber optic terminal equipment and the DFS slightly degrade the Allan deviation. Commercial, off-the-shelf-equipment was used in order to stay within cost constraints of the project.

After removing 82 microseconds of cable delay, the remote clock at DSS 24 is within ± 50 nanoseconds time offset of the master clock with a jitter of less than 2 nanoseconds. The timing distribution meets all system requirements at the remote antenna site.

REFERENCES

- [1.] M. Calhoun, P. Kuhnle, and J. Law, "Environmental Effects on the Stability of Optical Fibers used for Reference Frequency Distribution", Proceedings of the Institute of Environmental Sciences, Las Vegas, NV, May 1993.
- [2.] M. Calhoun and P. Kuhnle, "Ultrastable Reference Frequency Distribution Utilizing a Fiber Optic Link", Proceedings, 24th Precise Time and Time Interval Applications and Planning Meeting, Tysons Corner, VA, December, 1992.

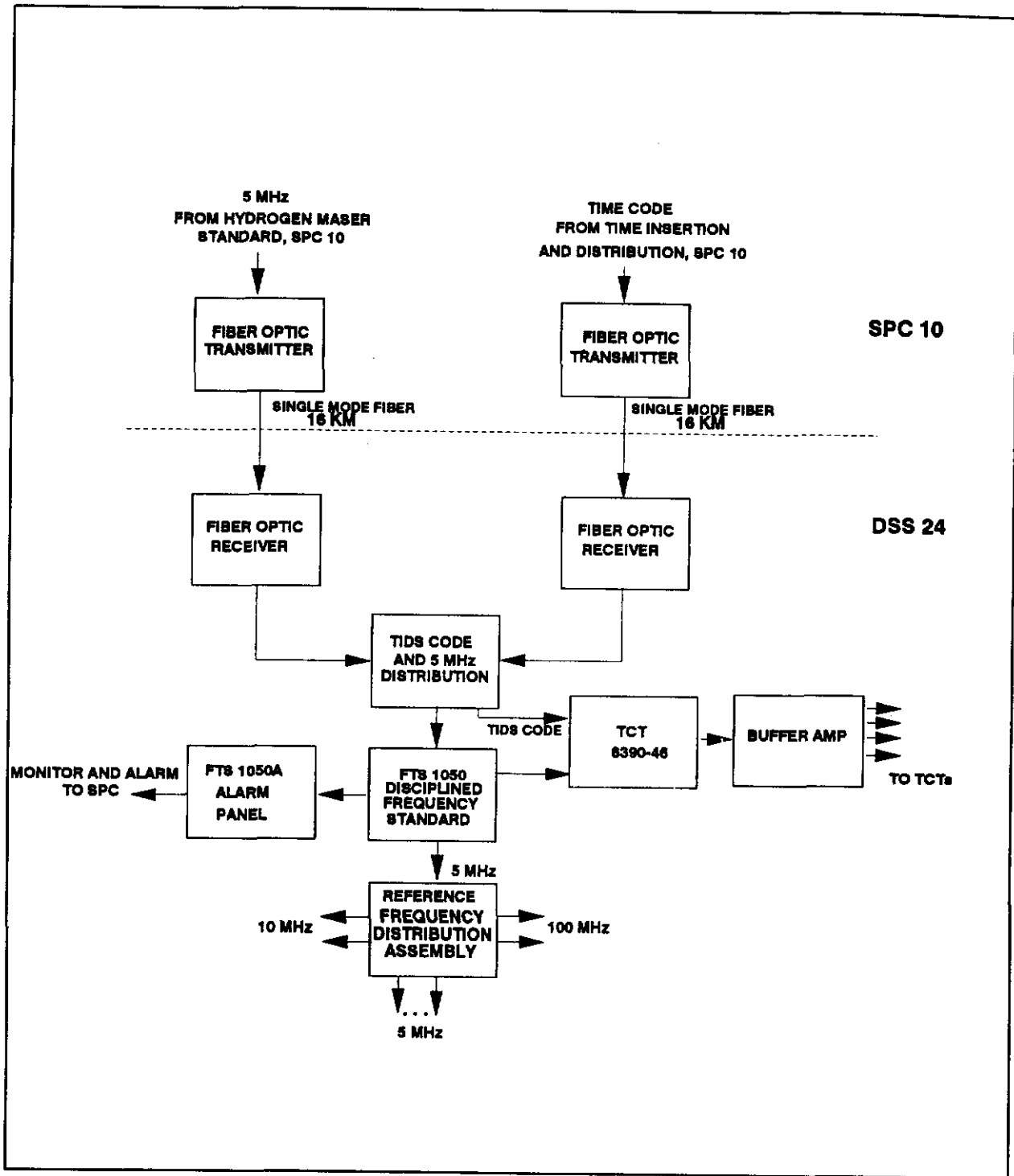

Figure 1. BLOCK DIAGRAM OF REFERENCE FREQUENCY AND TIMING DISTRIBUTION, SPC 10 TO DSS 24.

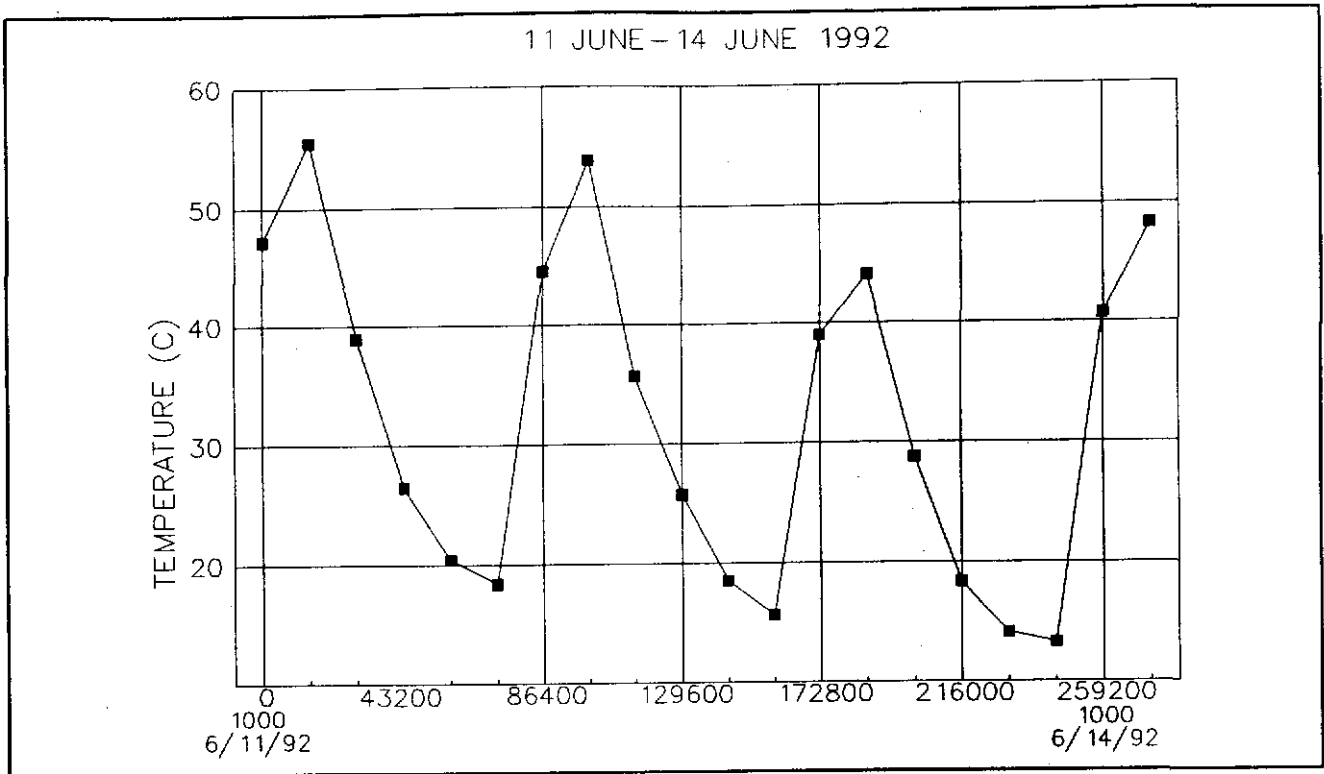

Figure 2. SURFACE TEMPERATURE MEASURED AT GOLDSTONE TRACKING STATION

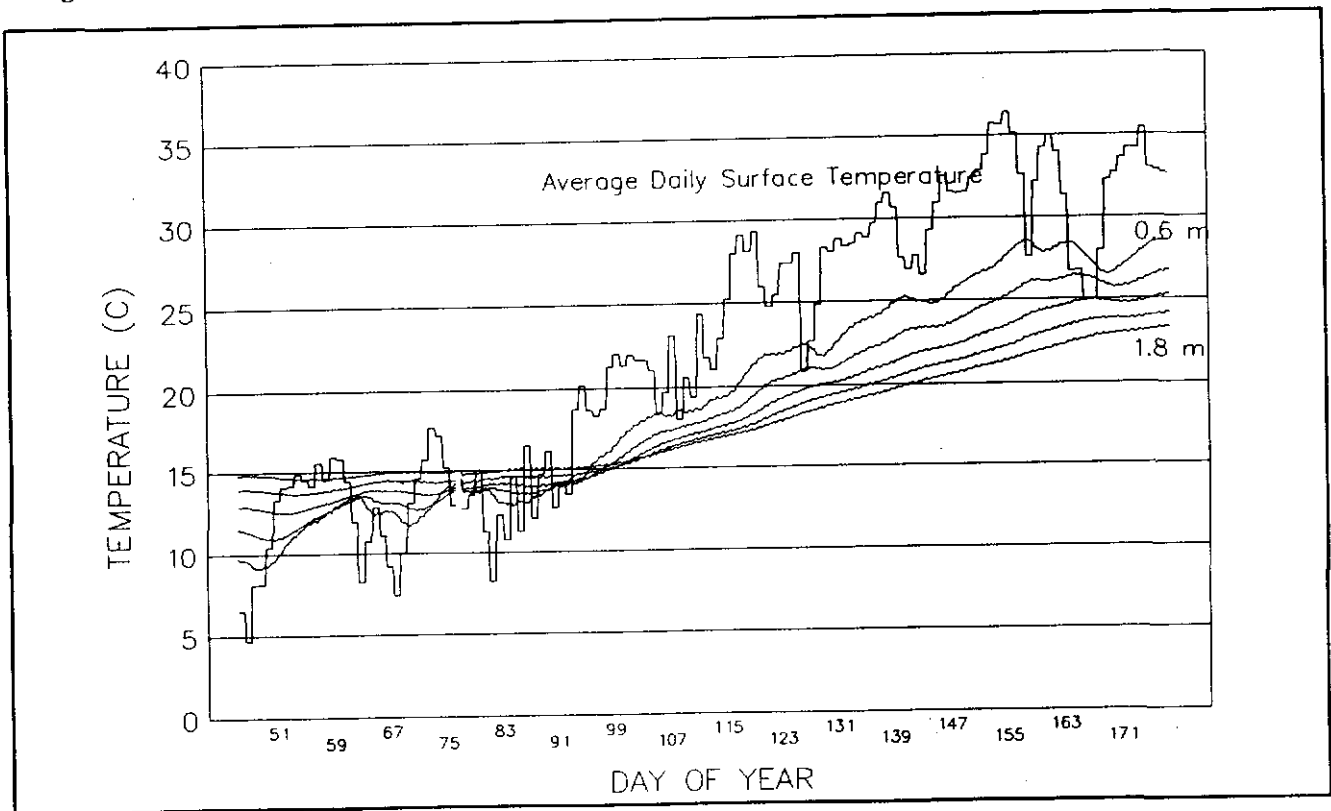

Figure 3. GROUND TEMPERATURE MEASURED AT GOLDSTONE TRACKING STATION

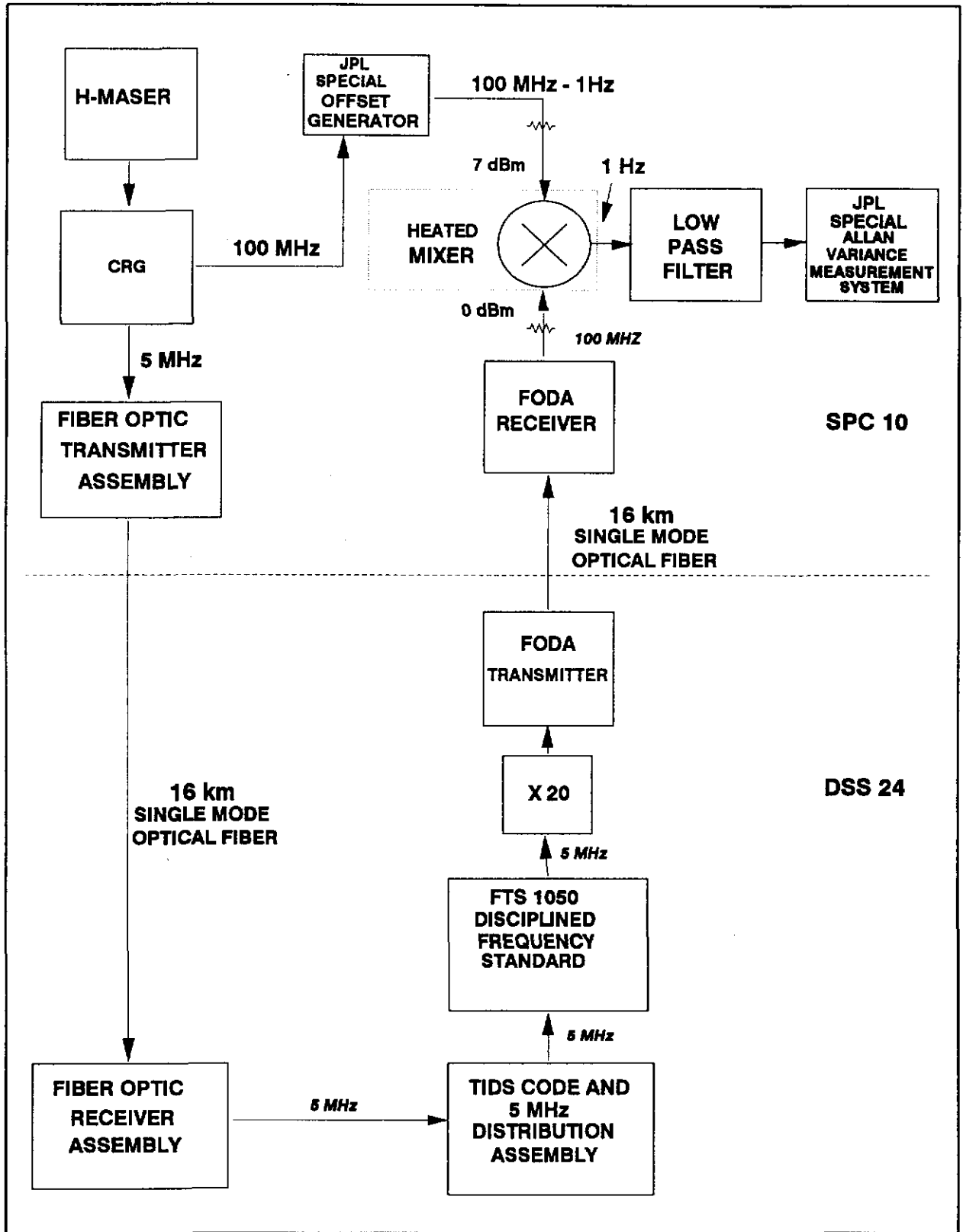

Figure 4. TEST CONFIGURATION FOR ALLAN DEVIATION MEASUREMENT, SPC 10 TO DSS 24.

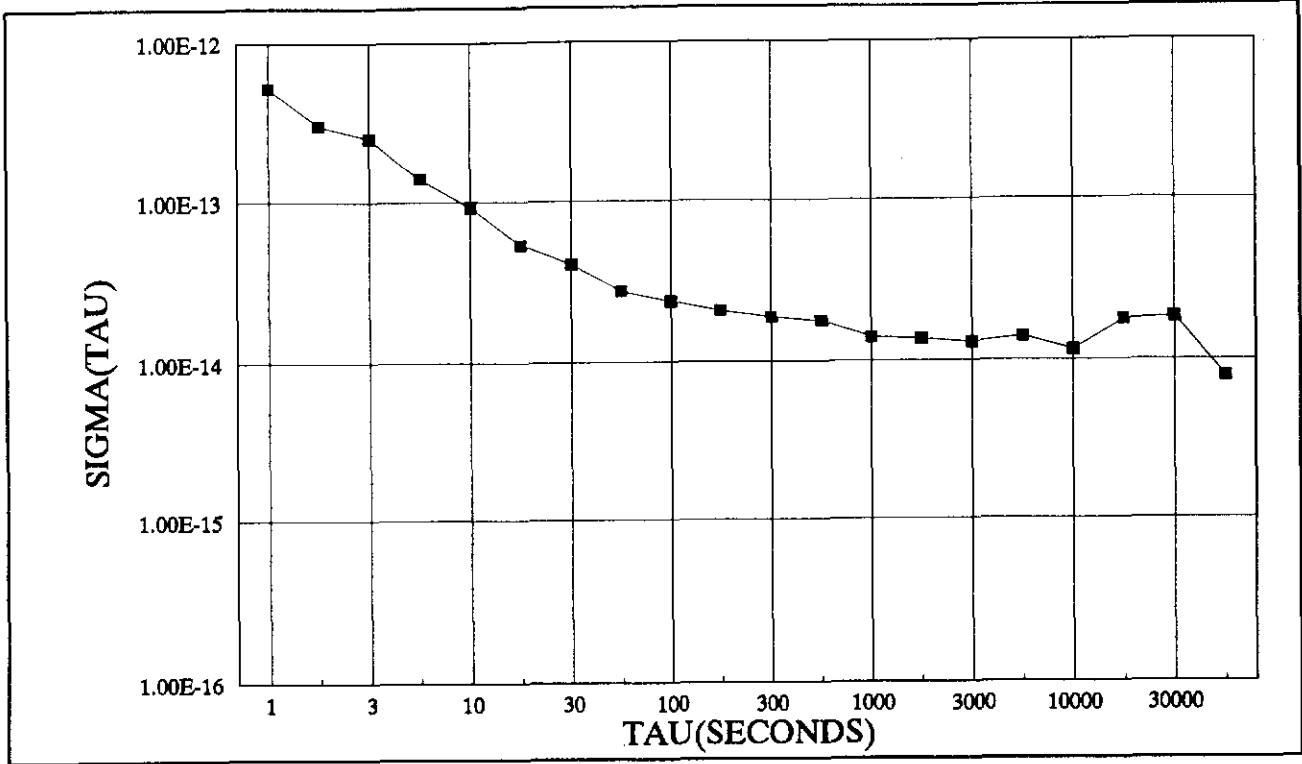

Figure 5. ALLAN DEVIATION AT DSS 24 WITH 420 METERS OF EXPOSED FIBER OPTIC CABLE

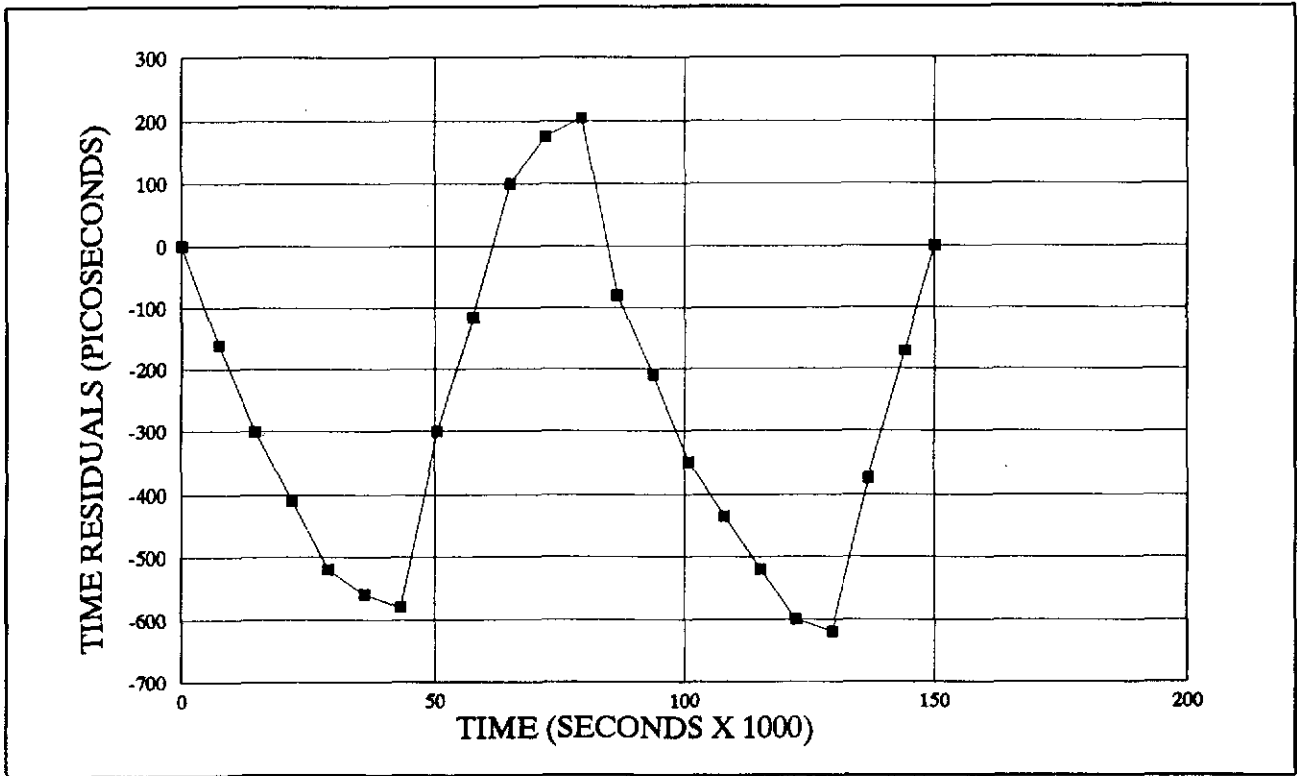

Figure 6. TIME RESIDUALS AT DSS 24 WITH 420 METERS OF EXPOSED FIBER OPTIC CABLE.

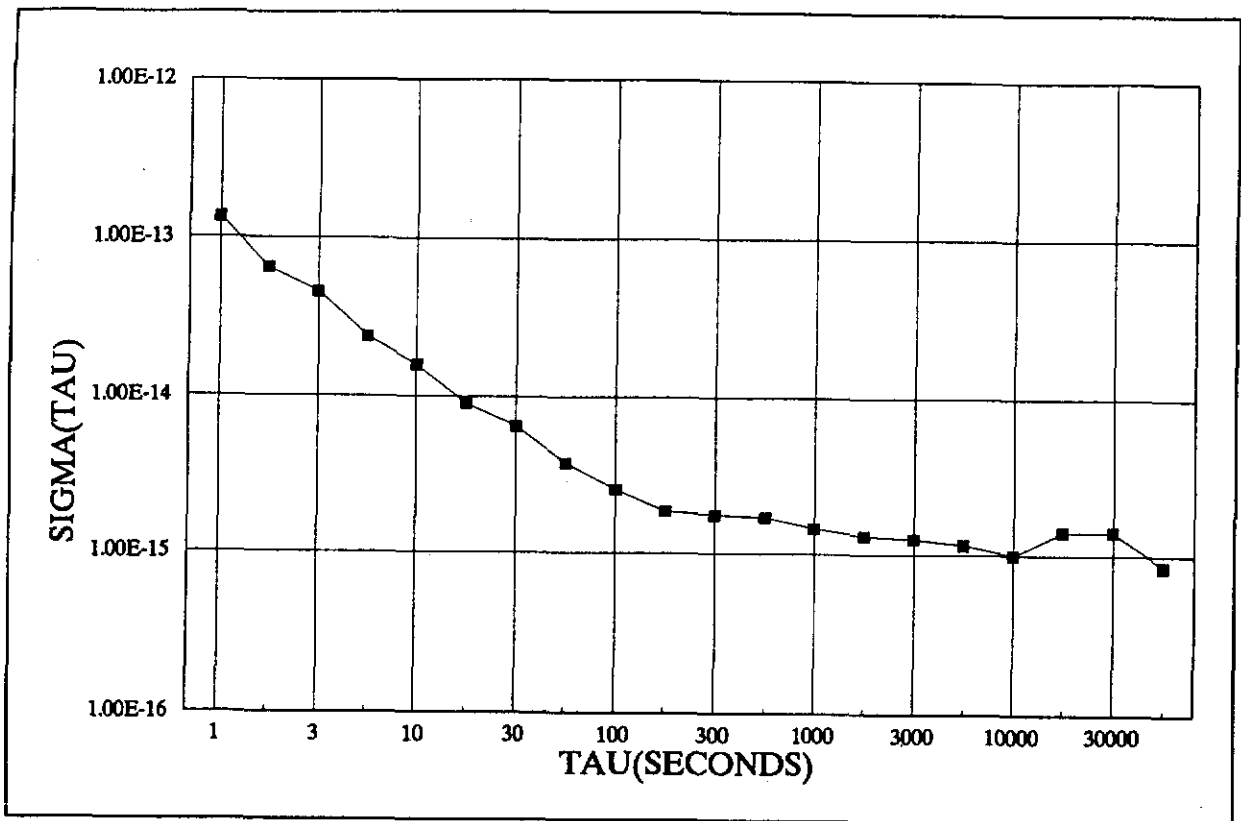

Figure 7. ALLAN DEVIATION AT DSS 24 WITH 16 km OF BURIED FIBER OPTIC CABLE

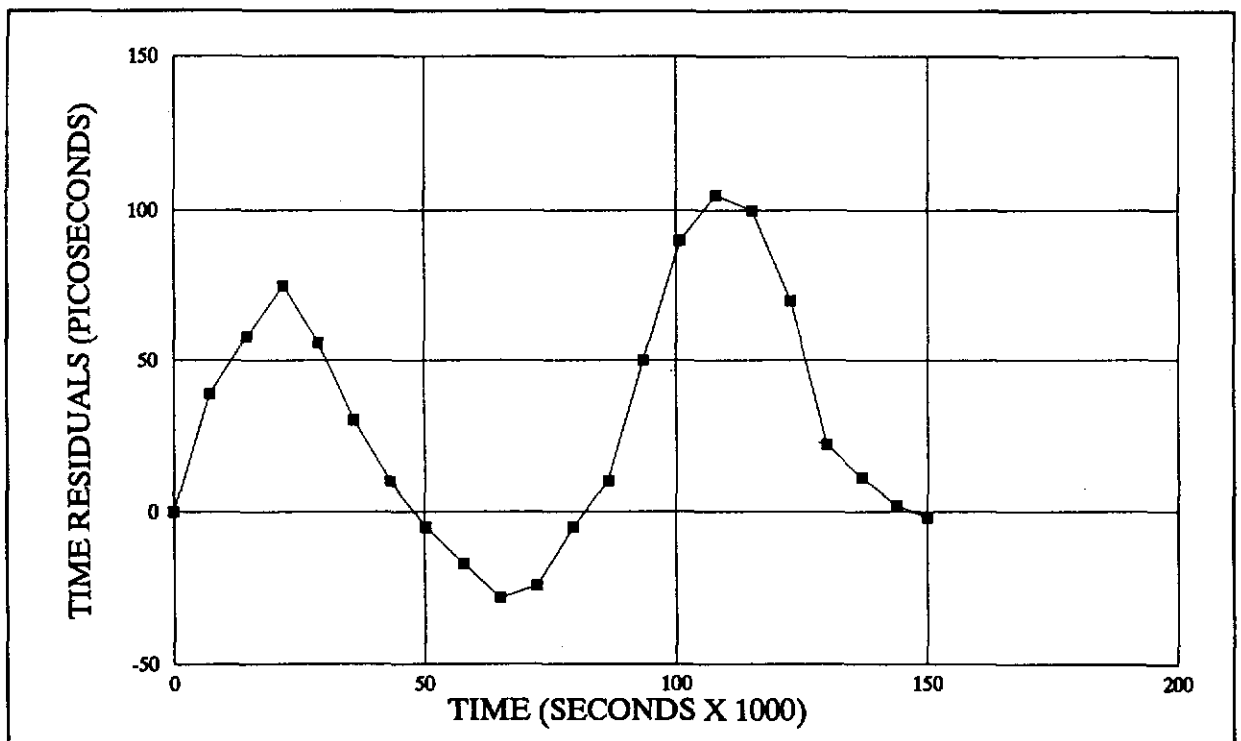

Figure 8. TIME RESIDUALS WITH 32 km OF BURIED FIBER OPTIC CABLE

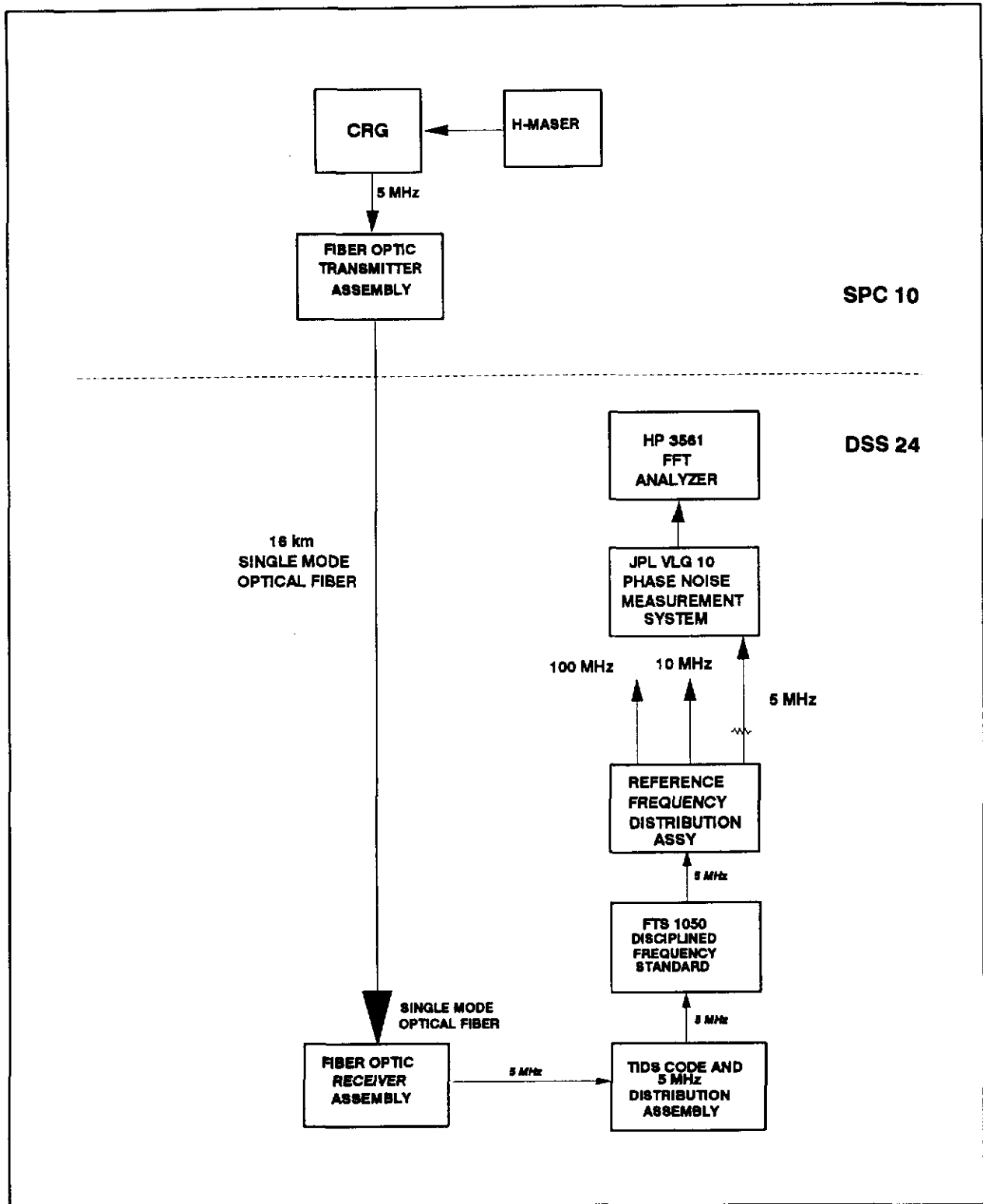

Figure 9. TEST CONFIGURATION FOR PHASE NOISE MEASUREMENT AT DSS 24

QUESTIONS AND ANSWERS

FREDERICK WALLS (NIST): How much of the phase noise degradation was due to the optical transmit received and how much due to fiber noise?

MALCOLM CALHOUN (JPL): Anything within about three or four Hz was degraded by the optical fiber transmitted and received. The band width of this frequency standard brought the noise floor down very rapidly. At 10 Hz, we're minus 140 dB below the carrier. And the floor on this was limited by the oscillator in the disciplined frequency standard; it's about minus 155. So it's just a little bit -- very close into the carrier.