

MEASUREMENT OF PRECISION OSCILLATOR PHASE NOISE USING THE TWO-OSCILLATOR COHERENT DOWN-CONVERSION TECHNIQUE

Christopher J. Pagnanelli and William F. Cashin
Ball Corporation, Efratom Division
Irvine, CA

Abstract

This paper addresses the characterization of precision frequency standard phase noise and spurious outputs using the two-oscillator coherent downconversion technique. This paper focuses on techniques for making accurate measurements of phase noise and spurious outputs within 100 KHz of a carrier. Significant sources of measurement error related to hardware design problems and inadequate measurement procedures are discussed, such as: measurement errors resulting from system noise sources, phase-locked loop effects, and system bandwidth limitations. In addition, methods and design considerations for minimizing the effects of such errors are presented. Analytic discussions and results are supplemented with actual test data and measurements made using measurement hardware developed at Ball Corporation, Efratom Division.

THEORY OF OPERATION

Two-oscillator coherent downconversion is a process by which the noise fluctuations and spurious outputs of a test oscillator are converted to equivalent baseband voltage fluctuations. As shown in Figure 1a, the basic ideal system consists of a test oscillator, a noiseless reference oscillator, an ideal mixer, a noiseless amplifier, and a spectrum analyzer. The spectrum analyzer is used to measure the power of the voltage fluctuations at the output of the coherent downconverter. Although this technique is commonly used at Efratom to make phase noise and spurious outputs measurements on precision frequency standards having output frequencies of 5 MHz or 10 MHz, coherent downconversion is a suitable technique for making noise measurements at any test oscillator frequency.

Random voltage fluctuations, at the output of the coherent downconverter, are produced by test oscillator phase noise and are expressed in terms of spectral density (dBc/Hz or dBV/Hz). However, making noise power measurements in a 1 Hz bandwidth can be inconvenient. For this reason, random noise power is typically measured in some known bandwidth and is then converted to an equivalent spectral density under the assumption that the voltage fluctuations approximate white noise within the measurement bandwidth. The conversion from noise power to noise spectral density can be realized by adding a correction factor equal to $10\log(1/BW)$ to the measured noise power.

The term BW is noise bandwidth and is approximately equal to the resolution bandwidth of the spectrum analyzer used during the measurement. Most modern low frequency, digital spectrum analyzers can be configured to display measurements as spectral densities. Voltage-relative spectral densities, in units of dBV/Hz, can be converted to carrier power-relative spectral densities, in units of dBc/Hz, by taking into account the carrier power of the test oscillator.

Deterministic voltage fluctuations, at the output of the coherent downconverter, are produced by test oscillator spurious outputs. Deterministic voltage fluctuations are narrowband and are, therefore, expressed in terms of spectral power (dBc or dBV). Spurious outputs are generally measured in units of dBV and are then converted to more meaningful carrier power-relative units of dBc by taking into account the carrier power of the test oscillator.

Since, in the ideal case, the reference oscillator has no phase noise, its output $v_r(t)$ can be represented by a pure sinusoid;

$$v_r(t) = A_r \sin[2\pi(f_r)t]. \quad (1)$$

The output of the test oscillator differs from a pure sinusoid in that it is modulated in amplitude, frequency, and/or phase by random and deterministic noise. Although all these modulation components contribute to the overall spectral density of the test oscillator output, treatment of each is beyond the scope of this paper. Therefore, for simplicity the effects of frequency modulation and amplitude modulation will be ignored. The resulting output of the test oscillator, $v_0(t)$, is given by

$$v_0(t) = A_0 \sin[2\pi(f_0)t] = \Phi(t). \quad (2)$$

The term $\Phi(t)$ accounts for both random and deterministic phase fluctuations, which are typically referred to as phase noise. The output, $m(t)$, of the ideal mixer is the product of the reference and test oscillator outputs and is given by

$$m(t) = [(A_r/2)K_a A_0] \{ \sin[2\pi(f_r - f_0)t + \Phi(t)] + \sin[2\pi(f_r + f_0)t - \Phi(t)] \}. \quad (3)$$

The term K_a is the low noise amplifier gain and the term $A_r/2$ can be thought of as the conversion gain/loss of the ideal mixer. Assuming that the reference oscillator and test oscillator are stable enough that they can be set to the same output frequency (i.e. $f_r = f_0$) and can be maintained in a quadrature phase relationship, then the output of the ideal mixer is given by

$$m(t) = [(A_r/2)K_a A_0] \{ \sin[\Phi(t)] + \sin[2\pi(2f_0)t - \Phi(t)] \}. \quad (4)$$

The sum term is filtered away via a discrete filter, or via the bandwidth limitations of the low noise amplifier and/or spectrum analyzer, leaving only the difference frequency term. If a small signal approximation is made for $\Phi(t)$, then

$$\sin[\Phi(t)] \sim [\Phi(t)] \quad (5)$$

and the filtered output, $m_f(t)$, of the ideal coherent downconverter is approximately given by

$$m_f(t) = [(A_r/2)K_a A_0] \Phi(t). \quad (6)$$

As equation 6 indicates, the output of the ideal coherent downconverter is a baseband signal having voltage fluctuations which are proportional to the phase noise fluctuations of the test oscillator.

Practical implementations of the coherent downconverter usually differ from the ideal implementation in several respects. One difference is that the ideal mixer is generally implemented as a double-balanced diode mixer to provide inherent input/output isolation, and to provide AM rejection and rejection of some spurious outputs applied to the non-linear (LO) port. Modern double-balanced mixers use schottky diodes which have an exponential voltage versus current response. The output of the double-balanced schottky diode mixer is, therefore, a highly nonlinear function containing many high-order terms. In addition to sum and difference frequency products, the mixer generates harmonic intermodulation products at frequencies equal to $[\pm M f_r \pm N f_0]$, where M and N are integers. Although double balancing serves to suppress products formed by even values of M and N , even products are nonetheless present.

In addition to producing harmonic intermodulation products, a double-balanced diode mixer has only one linear input port (the RF port) and its conversion gain/loss is a nonlinear function of the drive level applied to the nonlinear port (the LO port). Ignoring all but the first-order mixer products, and assuming that the reference oscillator output drives the nonlinear mixer port, then the filtered coherent downconverter output for a double-balanced mixer takes the form

$$m_f(t) = [G_m(A_r)K_a A_0] \sin[2\pi(f_r - f_0)t]. \quad (7)$$

In equation 7, the nonlinear function $G_m(A_r)$ replaces the term $A_r/2$ in equation 6 as the conversion loss of the of the double-balanced mixer.

Although Gilbert cell mixers, such as modern active FET mixers, are a better approximation of the ideal mixer (having a square law relationship of voltage versus current response), the noise performance of such mixers has in the past been inferior to that of schottky diode mixers. It is also more difficult to implement double-balanced mixers with FETs than with schottky diodes, which is probably why the schottky diode mixers are used more frequently despite their lack of conversion gain. References 3 and 4 are useful sources of more information on the subject of mixers.

A second difference between the ideal and non-ideal system is that the frequency coherence and quadrature relationship between the reference and test oscillators is difficult to maintain manually. For this reason, servo electronics are typically employed. Since the double-balanced mixer acts as a phase detector, it includes an implicit integration (converting the oscillator frequency into phase). Therefore, a second integrator is usually the only additional circuitry required to implement a phase-locked servo loop. This is conveniently realized using an active lag-lead filter as shown in Figure 1b. If the frequency of the reference oscillator is not electronically controllable, than additional hardware may also be required to provide this feature.

Ideal and non-ideal systems also differ in that reference oscillator phase noise and low noise amplifier voltage noise contribute to the overall voltage fluctuations at the output of the coherent downconverter in practical systems. Although in some cases the noise contributions of the reference oscillator and low noise amplifier are insignificant, with regard to the measurement of precision oscillator phase noise this is generally not the case. Obtaining lower noise reference oscillators was essential for upgrading Efratom's phase noise test equipment to provide for more accurate, repeatable measurements.

Advantages/Disadvantages of the Coherent Downconversion Technique

When using the coherent downconversion technique, it is possible to make accurate measurements of precision oscillator phase noise and spurious outputs at small carrier offset frequencies. Such

measurements are difficult or impossible with some of the other phase noise measurement techniques. Direct spectrum analyzer measurements of phase noise and spurious outputs, for example, are limited by the resolution bandwidth and dynamic range of the spectrum analyzer. The noise power within the resolution bandwidth of the measurement must be large enough to overcome the dynamic range constraints of the spectrum analyzer. Thus, wide resolution bandwidths are required for making low level noise density measurements using the direct spectrum analyzer technique. However, it is difficult to make measurements at carrier offset frequencies much less than several times the measurement resolution bandwidth. Therefore, measurement of phase noise at low carrier offset frequencies requires use of a narrow resolution bandwidth. When narrow resolution bandwidths are employed, the noise power within the resolution bandwidth may be too low to overcome the dynamic range constraints of the spectrum analyzer. These measurement limitations, which are imposed by the frequency resolution and dynamic range constraints of spectrum analyzers, are avoided by using the coherent downconversion technique.

High-frequency commercial spectrum analyzers have frequency resolutions which are typically no better than 10 Hz and have dynamic ranges on the order of 80 dB. The 10 Hz resolution bandwidth limitation makes direct spectrum analyzer measurements difficult for carrier offsets much less than 100 Hz. Although suppressing the carrier in direct spectrum analyzer measurements with a calibrated narrow band notch filter can enhance measurement dynamic range by as much as 30 dB, this is generally insufficient improvement for making close-in phase noise measurements on precision oscillators. At offsets of 100 Hz, precision oscillator phase noise specifications can be better than -155 dBc/Hz. Assuming a measurement dynamic range of 110 dB and a frequency resolution of 10 Hz, the lower limit of direct spectrum analyzer noise measurements is -120 dBc/Hz. In comparison, coherent downconverter systems may have measurement capability which is better than -160 dBc/Hz at 100 Hz carrier offsets.

The graphs in Figure 2 are plots of the noise floor of the Efratom 5 MHz Phase Noise Tester, and demonstrate the low-noise measurement capability of coherent downconversion systems. The data was generated using two low noise 5 MHz oscillators. For each graph, output voltage fluctuations, in units of dBV/Hz, are plotted versus carrier offset frequency in Hz. The dBV/Hz readings are converted to dBc/Hz readings by subtracting 36 dB to take into account the power of the carrier at the output of the coherent downconverter. Therefore, according to Figure 2, phase noise measurements to nearly -160 dBc/Hz are possible at carrier offsets of 100 Hz and measurements to nearly -170 dBc/Hz are possible at carrier offsets of 10 KHz.

Phase noise and spurious outputs measurements using the coherent downconversion technique have several disadvantages, however. One disadvantage is the inability to distinguish lower sideband noise from upper sideband noise. Since coherent downconverter measurements are double-sideband measurements, the voltage fluctuations which appear at the output of the coherent downconverter are due to the combined effects of upper and lower sideband noise. Thus, measurement errors can result if an invalid assumption of sideband symmetry is made in converting double-sideband measurements to single-sideband measurements. Another disadvantage is that coherent downconverter systems are more complex and require significantly more hardware than direct measurement systems. This added complexity introduces various error sources which must be accounted for if accurate measurements are to be made. These disadvantages, however, are generally outweighed by the ability to make very low phase noise measurements close to the carrier using the coherent downconversion technique.

Conversion From Units of dBV to Units of dBc

In order to convert voltage-relative spectrum analyzer measurements to more useful carrier power-relative measurements, the amplitude of the test oscillator at the output of the coherent downconverter must be determined. Carrier amplitude can be accurately measured by producing a frequency offset between the test and reference oscillators and measuring the slope of the resultant beat note. If the test and reference oscillators are not at the same frequency and if the sum frequency and noise terms are ignored, then the coherent downconverter output, given by equation 3, becomes

$$m(t) = [G_m(A_r)K_a A_0] \sin[2\pi(f_r - f_0)t]. \quad (8)$$

This output beat note is usually severely clipped because of the voltage swing limitations of the low noise amplifier. Therefore, it is not possible to measure the peak voltage of the beat note directly. Measurement of beat note amplitude can be measured indirectly, however, by observing the slope of the rising and/or falling edges of the clipped waveform. It can be shown that the peak amplitude of the beat note is given by

$$[G_m(A_r)K_a A_0] = \frac{m(t_2) - m(t_1)}{\sin[2\pi(f_r - f_0)t_2] - \sin[2\pi(f_r - f_0)t_1]}. \quad (9)$$

Since only points on the beat note near the zero crossing are observed, the small signal approximation for a sinusoid is valid and equation 9 becomes

$$[G_m(A_r)K_a A_0] \simeq \frac{m(t_2) - m(t_1)}{2\pi(f_r - f_0)(t_2 - t_1)} \quad (10)$$

$$= \frac{m(t_2) - m(t_1)}{t_2 - t_1} \times \frac{T}{2\pi}, \quad (11)$$

where T is the period of the beat note equal to $\frac{1}{f_r - f_0}$. Since voltage fluctuations are measured in units of dBV/Hz, beat note power P is usually expressed in units of dBV,

$$P\{[G_m(A_r)K_a A_0]\} = 20 \log\left[\frac{m(t_2) - m(t_1)}{t_2 - t_1} \times \frac{T}{2\pi}\right] + 3 \text{ dB}. \quad (12)$$

The beat note/carrier power is commonly referred to as the "gain" of the coherent downconverter.

The 3 dB correction factor in equation 12 accounts for conversion from double-sideband to single-sideband in phase noise measurements (by convention, phase noise $\mathcal{L}(f)$ is defined as an upper sideband measurement) and conversion from peak to RMS in spurious outputs measurement. An additional 3 dB correction factor for conversion from double-sideband to single-sideband is sometimes included in spurious outputs measurement, resulting in an overall correction factor of 6 dB. However, the extra 3 dB for spurious outputs is valid only if the lower sideband spur is equal in amplitude and phase to the upper sideband spur. It is possible that the lower sideband spur amplitude is significantly different from that of the upper sideband spur. Therefore, the accepted method is to assume that one sideband does not contribute to the measured spur amplitude so that the same 3 dB correction factor is applied to both phase noise, $\mathcal{L}(f)$, and spurious outputs measurements.

SOURCES OF ERROR IN PHASE NOISE/SPURIOUS OUTPUTS MEASUREMENT

The limitations imposed by practical realizations of the ideal coherent downconverter result in error sources which must be accounted for in order to make accurate phase noise measurements. Usually, it is not difficult to eliminate and/or to compensate for these sources of error.

Reference Oscillator Noise

With regard to the phase noise measurement of precision frequency standards, the contribution made to coherent downconverter output voltage fluctuations by the reference oscillator noise cannot be neglected. If reference oscillator noise contributes significantly to the output voltage fluctuations of the coherent downconverter, then the reference oscillator output cannot be represented as a pure sinusoid. The output of a noisy reference oscillator is given by

$$v_r(t) = A_r \sin[2\pi(f_r)t - \Theta(t)], \quad (13)$$

where $\Phi(t)$ is the phase noise of the reference oscillator and, for illustration, frequency and amplitude noise have been ignored. Assuming that the reference oscillator drives the mixer nonlinear port and that the reference oscillator and test oscillator output frequencies are equal and in quadrature, then the coherent downconverter output is given by

$$m(t) = [G_m(A_r)K_a A_0][\Phi(t) + \Theta(t)], \quad (14)$$

neglecting all but the first-order difference term.

Equation 14 implies that the significance of reference oscillator noise depends on its power relative to the test oscillator noise. Reference oscillator noise relative to reference oscillator carrier power is less important due to the nonlinear operation of the mixer which causes test set gain to be relatively independent of reference oscillator carrier power. Reference oscillator noise is summed with the test oscillator noise to produce voltage fluctuations at the coherent downconverter output. The degree to which output voltage fluctuations increase as a function of reference oscillator noise power relative to test oscillator noise power is given in Table 1. As the table indicates, reference oscillator phase noise becomes significant when its power is greater than approximately -10 dB relative to test oscillator phase noise power. For these reasons, the effects of reference oscillator phase noise are minimized when the mixer LO nonlinear port is driven with the reference oscillator output at as low a level as possible to ensure on/off switching of the mixer diodes and the mixer linear port is driven with the test oscillator output at as high a level as possible without nearing the breakdown region of the mixer diodes.

Note that this approach contradicts the normal procedure of driving the LO port as hard as possible and the RF port as low as possible to get minimum intermodulation products (see references 1, 5, and 6). The actual optimal drive levels will be a compromise between the requirements for minimizing reference oscillator noise and for minimizing intermodulation products. These levels will depend on the noise contributions of the mixer/low pass filter, the test oscillator, and the reference oscillator. Note when testing units with a range of output amplitudes, low noise, variable-gain amplifiers may be employed to optimize mixer drive levels to achieve the best overall system performance.

To this point, it has been assumed that either the LO nonlinear port of the double-balanced mixer is driven with the reference oscillator output or that the reference oscillator and test oscillator output amplitudes are equal. The first is generally a good practice because noise and spurious outputs measurements made on a test oscillator are most meaningful to system designers when they are expressed relative to test oscillator carrier power. As mentioned previously, to convert voltage-relative measurements (in units of dBV) to carrier power-relative measurements (in units of dBc) the carrier power at the output of the coherent downconverter must be determined. The gain of the coherent downconverter is a measure of test oscillator carrier power only when the test oscillator drives the linear port of the mixer. This is because the nonlinear (LO) port of the mixer approximates a hard-limiter when it is driven hard to minimize unwanted intermodulation products. For this condition, mixer output power is approximately independent of nonlinear port drive level. Thus, if the test oscillator output drives the mixer nonlinear port, then coherent downconverter gain becomes a measure of reference oscillator carrier power. In this case, conversion of measurements from dBV/Hz to dBc/Hz results in the phase noise of the test oscillator being expressed relative to reference oscillator carrier power. Therefore, driving the mixer nonlinear port with the test oscillator output will result in measurement errors unless the reference oscillator carrier power is exactly equal to the test oscillator carrier power, or unless the oscillator power levels are accurately measured and the difference is taken into account. Ensuring such a condition may not be practical in a high volume production environment without expensive automated testing equipment and development.

Although driving the mixer nonlinear port with the test oscillator output will result in measurement errors when the amplitudes of the test and reference oscillator differ significantly, a potential advantage of this scheme is the suppression of test oscillator amplitude noise. Amplitude noise and angle noise are indistinguishable at the coherent downconverter output. If the amplitude noise of the reference oscillator is negligible, then driving the mixer nonlinear port with the test oscillator output provides a means of isolating test oscillator angle noise from test oscillator amplitude noise (see references 1 and 5).

Although reference oscillator noise is typically a significant error source in the measurement of precision oscillator phase noise, its effects can be accounted for in the phase noise measurement of a test oscillator if a third oscillator is available. As equation 14 indicates, output voltage fluctuations at the coherent downconverter output are approximately a linear function of the sum of reference oscillator and test oscillator phase noise fluctuations. Therefore, noise measurements made on each pair of three oscillators results in three independent linear equations which can be solved to determine the phase noise of the reference oscillator (keeping in mind the stochastic nature of the signals). Once reference oscillator phase noise is known, it can be subtracted from future phase noise measurements of test oscillators. This technique is sometimes referred to as a three-corner hat measurement [reference 1; Walls, *et al.*].

Low Noise Amplifier Effects

In addition to reference oscillator noise, low noise amplifier noise is another significant noise source with regard to the measurement of precision oscillator phase noise. The noise floor of the coherent downconverter system is a function of reference oscillator noise, mixer conversion loss and low noise amplifier noise. Therefore, careful attention should be given to the design or selection of the low noise amplifier.

PLL Tracking Effects

Servo electronics are typically employed in order to maintain the frequency coherence and quadrature phase relationship between the test and reference oscillators in coherent downconverter systems. Phase-locked loop (PLL) tracking effects, however, produce attenuation of test oscillator noise at frequencies significantly below the natural frequency of the loop and can, therefore, result in measurement errors. By examination of the block diagram in Figure 1b, the closed-loop transfer function from the coherent downconverter input to the coherent downconverter output can be written:

$$H(s) = \frac{\Phi_{out}}{\Phi_{in}} = \frac{2G_m(A_r)K_a A_0}{\pi} = \frac{s^2}{s^2 + s2\zeta W_n + W_n^2}, \quad (15)$$

where $W_n = \sqrt{\{4K_v G_m(A_r)K_a A_0/R_s C_f\}}$ and $\zeta = R_f C_f W_n/2$. The term K_v is the modulation sensitivity of the reference oscillator in units of hertz per volt. Equation 15 is the transfer function of a damped two-pole high-pass filter with a pole frequency at W_n . From equation 15 it is apparent that at frequencies much greater than W_n , phase noise fluctuations are amplified and at frequencies much below W_n , phase noise fluctuations are attenuated. The criteria for selection of the PLL filter is covered in many standard texts on phase-locked loops; reference 5 also includes a discussion.

Figure 3 contains plots of the measured spectral density of an Efratom commercial rubidium frequency standard (model FRS-C). Figure 3a is a plot of spectral noise at carrier offset frequencies ranging from 0 Hz to 5 Hz, measured using PLLs with three different natural frequencies. The results given in Figure 3a clearly demonstrate the effects of PLL tracking and their relation to loop natural frequency. Note that testing at low offset frequencies with a fast PLL loop can lead to significant errors in phase noise readings; over 18 dB at 1 Hz and 31 dB at 0.5 Hz for the measured FRS.

Because of PLL tracking effects, the bandwidth of coherent downconverter loops are generally very narrow (i.e., W_n is a low frequency). Not only does the use of narrow band loops minimize the errors associated with PLL tracking effects, but a secondary benefit is realized in that the noise contributions of the loop filter are minimized. Again, by examination of the block diagram in Figure 1b, the closed-loop transfer function from the loop filter input to the coherent downconverter output can be written

$$H(s) = \frac{e_{nout}}{e_{nin}} = \frac{2\zeta W_n + W_n^2}{s^2 + s2\zeta W_n + W_n^2}. \quad (16)$$

Equation 16 is a single-pole low pass filter response with a pole frequency at W_n . Therefore, the input voltage noise associated with the loop filter is attenuated at frequencies greater than W_n .

A disadvantage of narrow band servo loops is that they acquire very slowly. If the frequency offset between the test oscillator and the reference oscillator is large compared to the loop bandwidth, acquisition may require hours. This problem is typically overcome by incorporating variable bandwidth capability into the coherent downconverter servo loop design. Acquisition is achieved quickly with a wide loop bandwidth and measurements are made in a narrow band mode. Measurement systems at Efratom have successfully employed variable-bandwidth phase-locked loop designs.

System Bandwidth Limitations

While PLL effects cause low frequency noise measurement errors, system bandwidth limitations result in the attenuation of high frequency noise, and therefore, produce measurement errors at high

frequency. The availability of wide band, low-noise amplifiers reduces the severity of this problem, and generally, it is not difficult to design low noise measurement systems with bandwidths in excess of a few hundred kilohertz. For example, the latest measurement systems at Efratom typically exhibit only fractions of a dB of amplitude variation to frequencies of 100 KHz, as shown by the flat noise floor performance to 100 KHz in Figures 2d, 3d, and 4d. The phase noise measurement system at Efratom uses a Hewlett Packard model HP3561A spectrum analyzer, which has a maximum frequency span of 100 KHz. A 100 KHz frequency span is typical of fast-fourier real time spectrum analyzers, although Tektronix has recently introduced a 200 KHz model (model 2642).

The usable bandwidth of a coherent downconverter system can be extended by measuring the amplitude response of the system versus frequency, and incorporating frequency dependent calibration factors into the equation for system gain. This compensates for the high frequency attenuation imposed by system bandwidth limitations. The amplitude response of a coherent downconverter can be determined using two synchronized signal generators in place of the test and reference oscillators.

Frequency Conversion Effects

Unlike an ideal mixer, a double-balanced mixer produces harmonic intermodulation products. For this reason, spurious outputs which are far from the test oscillator carrier, and are outside the measurement bandwidth of the coherent downconverter, can be translated to frequencies which are within the measurement bandwidth of the system. Although harmonic intermodulation products are typically many decibels below the desired first-order mixer products, high-order spurious conversion products which fall within the system bandwidth are indistinguishable from spurious outputs which are close to the carrier. One key to minimizing these effects is to properly terminate the output (IF) port of the mixer. This issue is discussed in detail in reference 4.

Accurate measurement of spurious outputs using coherent downconversion requires that high frequency spurious outputs first be identified and measured using a direct spectrum analyzer technique. An analysis of mixer spurious outputs, which takes into account the specified harmonic intermodulation performance of the mixer, can then be performed to predict the location and level of high-order spurious conversion products. However, such an analysis is generally not practical in a large-scale production environment, and the source of spurious outputs is usually of little concern as long as they are within specified performance limits.

Frequency conversion effects become more significant when, instead of a sinusoid, the test oscillator output is a square wave which is rich in harmonic content. Harmonic intermodulation effects resulting from square wave inputs can be minimized by inserting low pass filters between square wave oscillator outputs and coherent downconverter inputs. This technique was utilized in the measurements of the FRS-C TTL-compatible output of Figure 3.

60-cycle Interference and the Use of Batteries

Sixty-cycle interference and its harmonics couple onto system power supplies and appear in the output frequency spectrum of the coherent downconverter. Although 60-cycle spurs are easily identified according to frequency, 60-cycle interference can camouflage actual spurious outputs performance. Through careful system design, 60-cycle interference can be minimized, however. Careful attention to grounding and the use of battery supplies can virtually eliminate 60-cycle interference from the output spectrum of the coherent downconverter.

The use of magnetic shielding around the sensitive front end of the downconverter may also be

required, along with shielding the control voltage to the reference oscillator, in order to minimize 60-cycle interference. The use of separate batteries for the phase noise tester, the reference voltage-controlled oscillator, and the test oscillator can prevent ground loops that cause unusual spurious results.

A side effect of using batteries is that performance anomalies may occur as the batteries become deeply discharged, depending on the sensitivity of the measurement system to supply voltage levels. Battery voltage monitors and associated disconnect relays can be employed to prevent this.

FFT Windowing Effects

Because of their superior frequency resolution, digital spectrum analyzers are generally used to measure voltage fluctuations at the output of the coherent downconverter. The choice of the windowing function used with fast-fourier transform (FFT)-based spectrum analyzers, however, can affect measurement accuracy. Phase noise measurements are most accurately made using the Hanning windowing function. The Hanning window has a narrow passband and very low sidebands, providing better measurement resolution for analyzing broadband signals like noise. Spurious outputs are most accurately measured using a flat top windowing function. Although the flat top window has higher sideband energy, its broad passband makes it better suited for measurement of narrow band, deterministic signals. Errors which result from incorrect window choice are typically less than 1 dB. Reference 8 goes into more detail on this subject.

Vibration Effects

Precision oscillators are frequently designed using quartz crystal resonators to achieve superior phase noise and short-term frequency stability performance. The phase noise of crystal oscillators is affected by vibration, however. The "G sensitivity" of a precision crystal is typically on the order of parts in $10^{-10}[df/f]/G$ to parts in $10^{-9}[df/f]/G$; this translates into phase noise and spurs by well established formulas. The Efratom "Time and Frequency Handbook" of reference 13 goes into this and other related subjects in more detail. References 11, 14, 15, and 16 present a broad overview of vibration and other effects on phase noise.

Because of vibration sensitivities, it is important to shield and dampen both the reference oscillator and the test oscillator from shock and vibration in order to obtain accurate quiescent phase noise readings. Otherwise, the ambient vibration levels of the test building or test table can increase the apparent phase noise floor of the oscillator.

In addition, the capacitance of the coaxial cable often changes with vibration. This can again result in an apparently degraded phase noise floor performance of a test oscillator due to the cable-induced loading effects related to ambient vibration levels.

When it is necessary to measure the vibration performance of an oscillator, a number of factors must be considered. Mechanical resonances in the fixture holding the test oscillator to the shaker can give errors, as can the type of coaxial cable used to connect the test oscillator to the phase noise tester. Electromagnetic interference (EMI) induced from the shaker head and the controller can also result in measurement errors, often requiring either shielding or separation of the measurement equipment from the shaker.

Miscellaneous Error Sources

A number of additional error sources may be encountered in the measurement of precision oscillator phase noise and spurious outputs. Although not exhaustive, these error sources include: poor grounding and intermittent grounding; inadvertent conversion of deterministic signal power measurements from dBV to dBc/Hz; injection locking of the test and reference oscillators due to inadequate EMI shielding; magnetic and electrostatic susceptibility and emissions of the test oscillator and/or reference oscillator; and failure to account for cable losses in high frequency measurements.

TEST DATA

Phase noise test performance was measured for two Efratom rubidium oscillator products for this paper. Rubidium oscillators frequency lock a voltage-controlled crystal oscillator to the long-term stability of the hyperfine atomic energy state transitions of the Rb^{87} atom. They are utilized to provide excellent long term frequency stability (on the order of parts in 10^{11} /month with excellent phase noise and spurious outputs performances).

The phase noise behavior expected from crystal oscillators is described in reference 7. The presence of a rubidium control loop will modify the ideal oscillator behavior in a number of ways depending on the relative phase noise of the rubidium physics package and the crystal oscillator. The rubidium loop crossover frequency controls the hand-off between the two; an improvement in phase noise or a lower slope below this frequency implies a good physics package phase noise relative to the crystal oscillator used.

The first unit evaluated was a model FRS-C; a stock, economical, commercial 10 MHz TTL-compatible rubidium oscillator. The FRS-C is specified for a phase noise of -110 dBc/Hz at 100 Hz carrier offset and -130 dBc/Hz at 1000 Hz offset. Non-harmonic spurious outputs are specified at -65 dBc. The second unit evaluated was a stock, commercial 10 MHz sine output low noise unit (model FRK-LN). The FRK-LN is specified for a phase noise of -120 dBc/Hz at a 10 Hz carrier offset and -147 dBc/Hz at 100 Hz and 1000 Hz offsets. Non-harmonic spurious outputs are specified at -70 dBc. Although units with better phase noise performance are available at Efratom, these two products are representative.

Test data for the FRS-C is given in Figure 3 and for the FRK-LN data in Figure 4. The phase noise test system used to make these measurements is an upgrade to that formerly used at Efratom, and is in a final phase of development. Because the development of the system is not yet complete, the final grounding and shielding configurations were not implemented, leaving some residual problems in the spurious outputs performance of the system.

The HP3561A spectrum analyzer, used to make the measurements which are displayed in Figures 2 through 4, was configured to provide for automatic conversion from noise power to noise spectral density. Thus, chart readings are displayed in units of dBV/Hz. The coherent downconverter gain was measured to be roughly 30 dB for both units, including the necessary correction factors for double-sideband to single-sideband conversion and for peak to RMS conversion. Therefore, the chart measurements should be adjusted by -30 dB to give phase noise performance in dBc/Hz. Since spurious outputs must be expressed in terms of power rather than spectral density, it is necessary to convert the displayed spurious output levels from units of dBV/Hz to units of dBV. This is done by adding a conversion factor equal to $10\log(\text{BW})$, where BW is the resolution bandwidth of the measurement displayed at the bottom of each graph. Spurious output levels, in units of dBV,

should then be adjusted by an additional -30 dB to give spurious outputs performance in units of dBc.

Figure 3a gives three plots of FRS-C phase noise performance within 5 Hz of the carrier. The different PLL natural frequencies are clearly shown for each plot. The rubidium servo loop crossover frequency is at roughly 35 or 40 Hz for this unit, as shown by the spectral leveling which occurs in Figure 3b. Spurious outputs at the modulation frequency of the rubidium control loop are evident in Figure 3c; the 127 Hz rubidium loop modulation spurious output is roughly -80 dBc, after applying a correction factor of +6 dBc to convert from spectral density to power.

The noise floor of this unit is measured to be roughly -140 dBc, as shown in Figure 3d. Two plots have been superimposed in Figure 3d. One plot drives the coherent downconverter directly with the square wave output of the test oscillator. In the second plot, the test oscillator drives the coherent downconverter through a 10.5 MHz low pass filter, which removes harmonic frequency components. Note the addition of the filter changes the level and frequency of the spurious outputs, indicating they may not be produced directly by the test oscillator. It is possible these spurious outputs are related to grounding and/or shielding effects; this will be verified with the final version of the Efratom phase noise tester being developed. Although the source of these relatively high-frequency spurious outputs is not known, the largest shown in Figure 3d occurs at an offset frequency of about 78 KHz. Its level, using the output low pass filter, is -98 dBc after applying a correction factor of +26 dBc to convert from spectral density to power. This is well below the -65 dBc spurious outputs specification of the unit.

Figure 4 gives similar performance curves for the model FRK-LN, 10 MHz unit. The rubidium servo loop crossover frequency occurs at about 2 Hz, as indicated by the spectral leveling shown in Figure 4a. Figure 4b gives phase noise performance to a carrier offset frequency of 100 Hz, while Figure 4c gives performance to an offset frequency of 1000 Hz. A spurious output at the modulation frequency of the rubidium control loop is shown in Figure 4c; the level of the 127 Hz spurious output is roughly -117 dBc, after correcting for carrier power and converting from spectral density to power. Figure 4d gives phase noise performance to an offset frequency of 100 KHz; the noise floor is shown to be roughly -157 dBc/Hz. Note that the noise floor is flat to the 100 KHz range of the spectrum analyzer.

CONCLUSION

The limitations imposed by practical realizations of the ideal coherent downconverter result in error sources which can result in inaccuracies in the measurement of precision oscillator phase noise and spurious outputs. Phase-locked loop tracking effects, system bandwidth limitations, and system noise can be significant sources of error. Most significant sources of error, however, can be eliminated and/or controlled through careful system design and calibration. The measurement system developed at Efratom has attempted to strike a balance between overall accuracy and volume testing in a production environment; the accuracy and repeatability for the production measurements performed at Efratom are on the order of 1 to 3 dB with an upgraded test measurement system and upgraded test procedure.

ACKNOWLEDGMENTS

The underlying principles of phase noise testing described in this paper are not new. The general subject has been covered in a number of papers and tutorial sessions, from both government sources (including the National Institute for Science and Technology, or NIST, at Boulder, Colorado and the US Army Laboratory Command at Fort Monmouth) and industry sources (Hewlett Packard, Raytheon, and others). Hopefully, this paper brings out new material with practical suggestions on designing and using phase noise testers that supplements the earlier work.

Dr. Fred Walls, Dave Allan, and David Howe and others at NIST (the National Institute for Science and Technology at Boulder, Colorado) have been of considerable help in broadening our understanding of phase noise measurement. They have developed techniques to accurately measure phase noise with 1 dB of accuracy for analysis bandwidths up to 10% of a carrier frequency up to a 1 GHz carrier, using a calibrated phase modulation technique and careful design [Walls, *et al.*]. These techniques have only been partially implemented in our current production phase noise test equipment at Efratom for two reasons; because of the need for inexpensive equipment used in a volume production environment, and because of our relatively narrow analysis bandwidth and low carrier frequencies tested (10 KHz to 100 KHz maximum bandwidths, and 5 MHz or 10 MHz carrier frequencies). However, the insights provided on error sources have been invaluable. Anyone new to the field wishing to gain a broad overview of time and frequency is well advised to attend the annual week long seminar provided by NIST.

Hewlett Packard has also been instrumental in providing a series of seminars, application notes and papers on phase noise measurement techniques (see references 9, 10). Their free seminars are well worth attending as well.

In addition, publications by John Vig and the US Army Laboratory Command have also provided valuable insight into the subject of precision oscillator phase noise performance in general.

References

- [1] Walls, F.L. and Felton, C.M., Clements, A.J.D., "Accuracy model for phase noise measurements," National Institute of Standards and Technology
- [2] Allan, David, *et. al.*, "Standard terminology for fundamental frequency and time metrology,"
- [3] Hayward, W., "Introduction to Radio Frequency Design," Prentice Hall, 1982
- [4] Maas, S., "Microwave mixers," Artech House, 1986
- [5] Wall, *et. al.*, "Design considerations in state-of-the-art signal processing and phase noise measuring systems," Frequency Stability: Fundamentals and Measurement, IEEE Press, 1983
- [6] Howe, David, "Frequency domain stability measurements: a tutorial introduction," NBS Technical Note 679, March 1976
- [7] Moulton, G., "Dig for the roots of oscillator noise," Microwaves & RF, April 1986
- [8] Benson, D., "Techniques for Signal and System Analysis," Tektronix, Inc., 1991
- [9] Scherer, D., "The 'art' of phase noise measurement," RF & Microwave Measurement Symposium and Exhibition, Hewlett Packard, August 1985

- [10] “ *Understanding and measuring phase noise in the frequency domain,*” Hewlett Packard, Application Note 207
- [11] Parker, T. and Montress, G., “*Introduction to phase noise measurements,*” Tutorial Presented at: 45th Annual Symposium on Frequency Control, 28 May 1991
- [12] Goldman, S., “*Phase noise leakage through a mixer,*” MSN & CT, November 1987, pp 88-96
- [13] “**Precision Time and Frequency Handbook,**” Ball Efratom Division, 8th Edition, 1991
- [14] Camhi, Alfred and Shniper, Sam, “*Predict source phase noise under vibration,*” Microwaves and RF, April 1991, pp. 83-86
- [15] Filler, Raymond L., “*The effects of vibration on frequency standards and clocks,*” Proceedings 35th Annual Frequency Control Symposium, Fort Monmouth, NJ: US Army Electronics Command, May 1981, pp. 31-39
- [16] Vig, John, *et. al.*, “*The effects of acceleration on precision frequency sources,*” Research and Development Technical Report SLCET-TR-91-3, Fort Monmouth, NJ: US Army Laboratory Command, March 1991

Table I. Increase in Measured Noise Versus Reference Oscillator Noise Relative to Test Oscillator Noise

Relative Amplitude of Ref Osc Phase Noise to Test Osc Phase Noise	Increase in Voltage Fluctuations at Coherent Downconverter Output
-20 dB	0.04 dB
-10 dB	0.42 dB
- 6 dB	0.97 dB
- 3 dB	1.76 dB
- 2 dB	2.12 dB
- 1 dB	2.54 dB
0 dB	3.01 dB
1 dB	3.54 dB
2 dB	4.12 dB
+3 dB	4.77 dB
+6 dB	6.99 dB

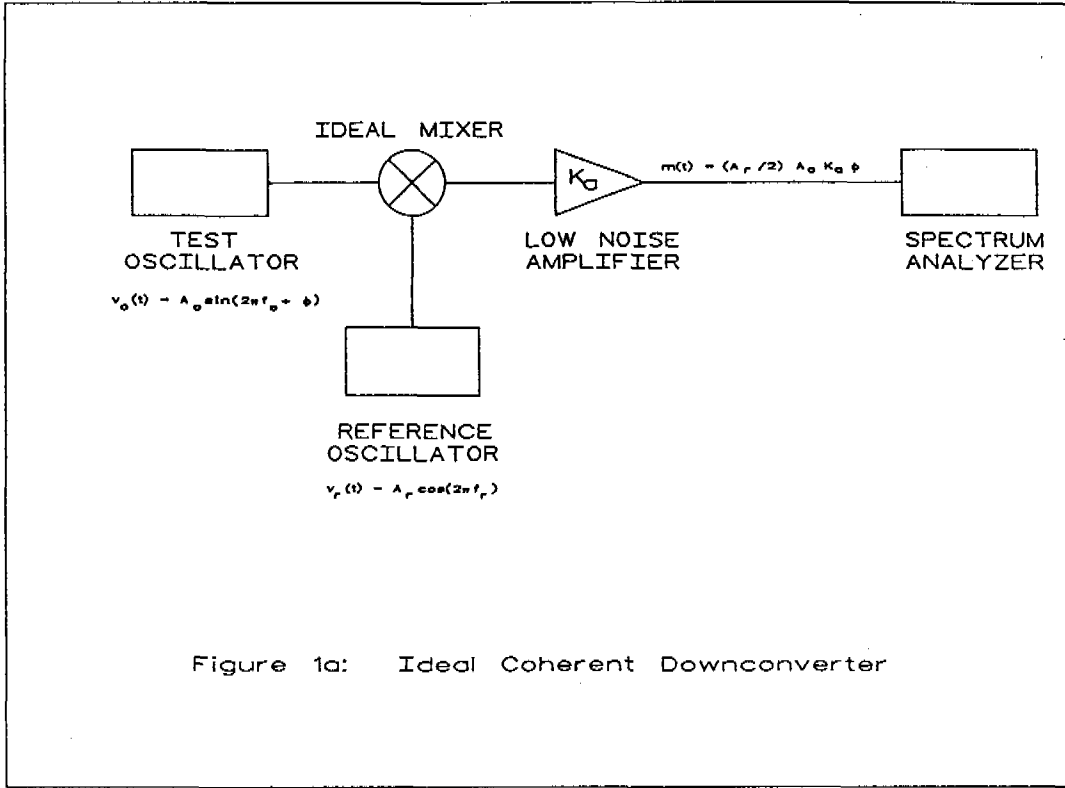

Figure 1a: Ideal Coherent Downconverter

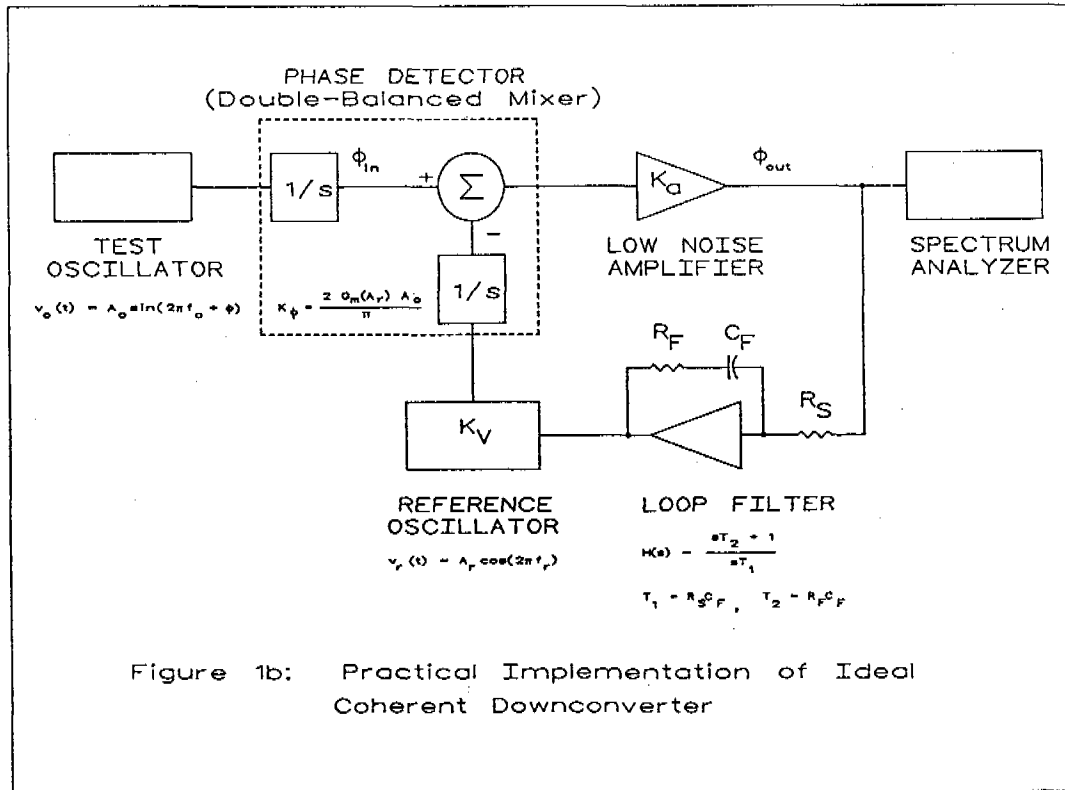

Figure 1b: Practical Implementation of Ideal Coherent Downconverter

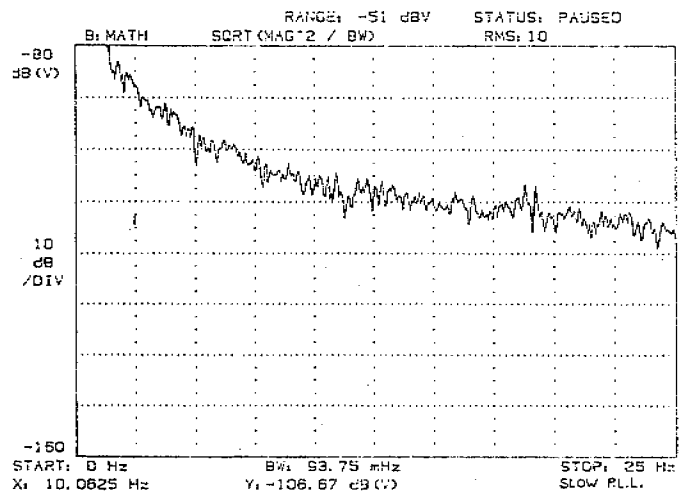

Figure 2a

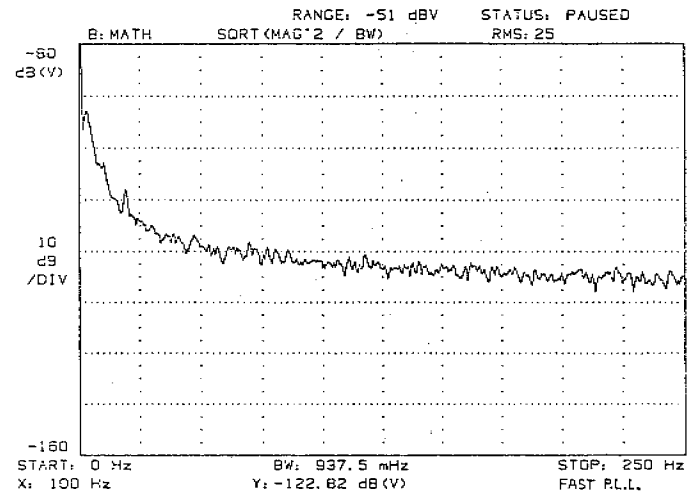

Figure 2b

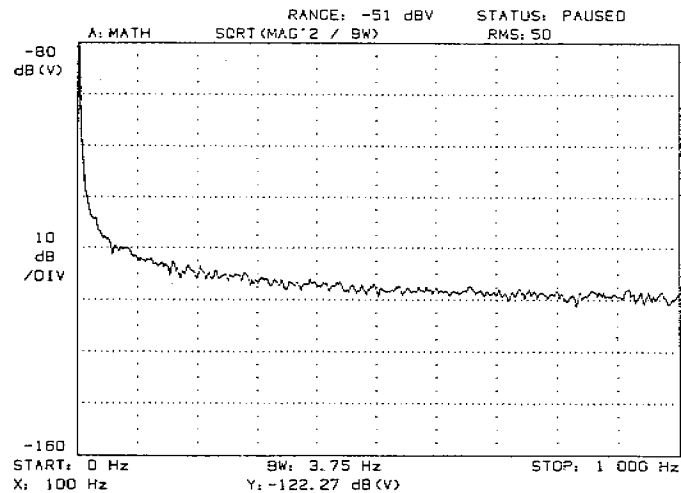

Figure 2c

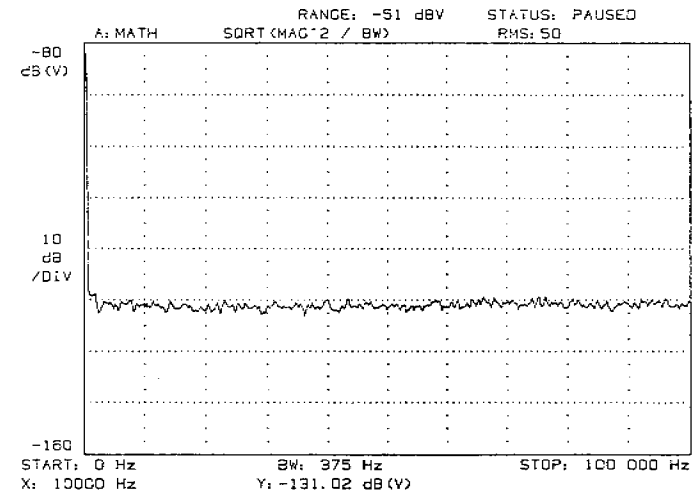

Figure 2d

(Test Set Gain ~ 33 dB)

Figure 2. 5 MHz LN Wensil Oscillators in Phase Noise Tester

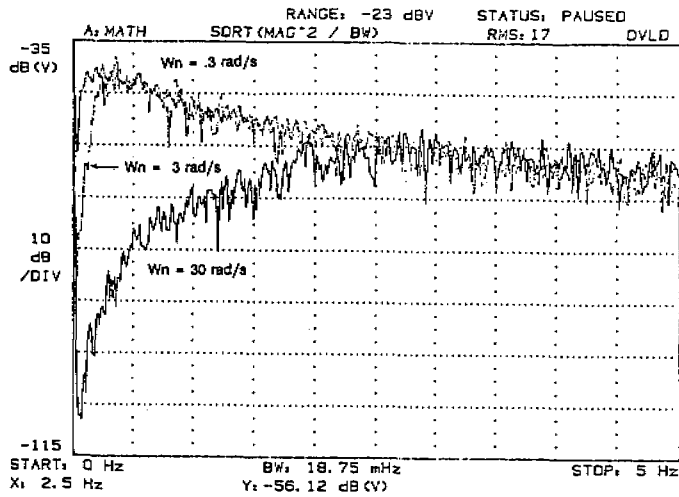

Figure 3a

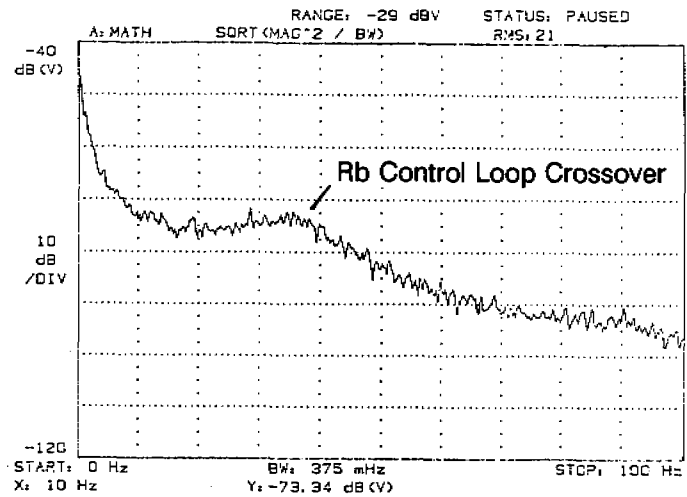

Figure 3b

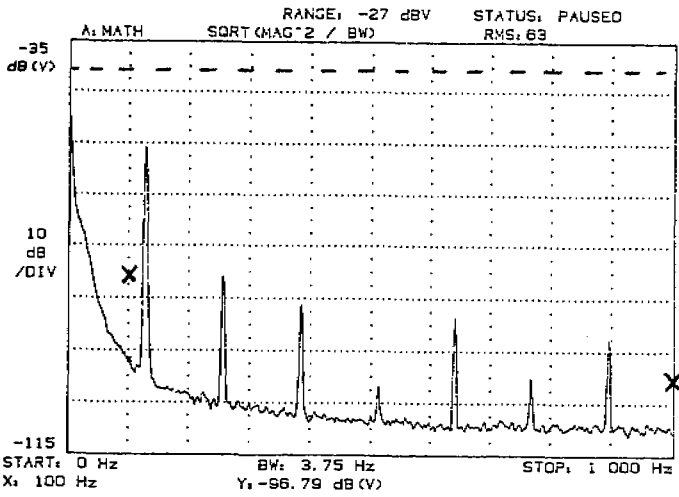

Figure 3c

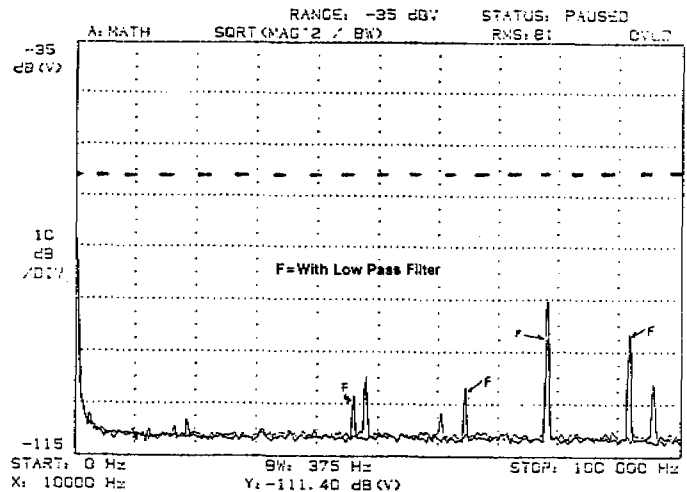

Figure 3d

Test Set Gain ~ 30 dB

--- Spur spec.
X Phase noise spec.

Figure 3. 10 MHz FRS-C Phase Noise Measurements (TTL Output)

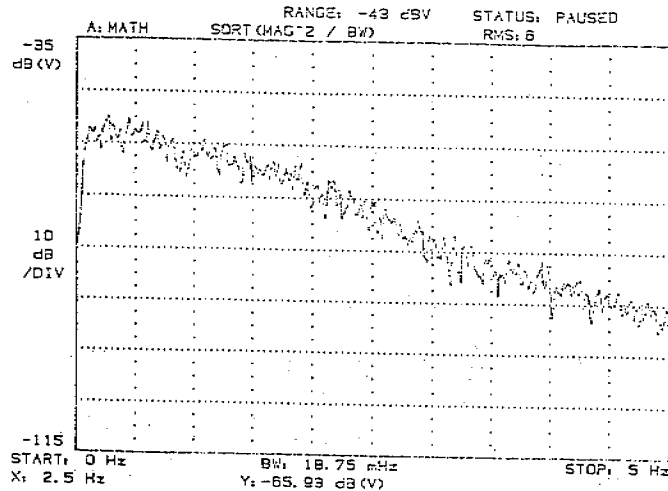

Figure 4a

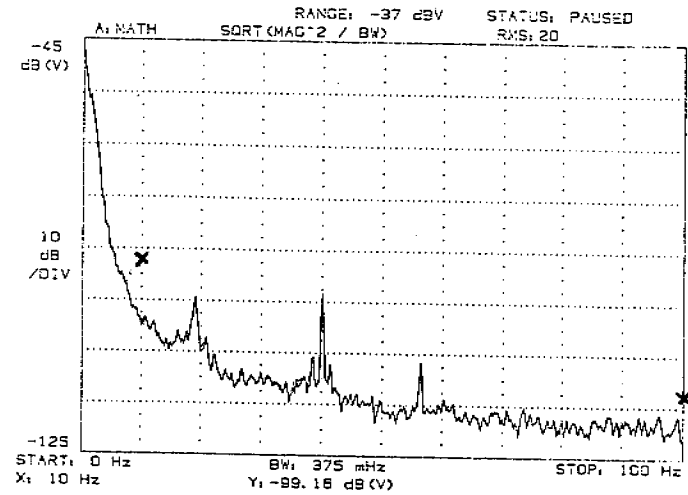

Figure 4b

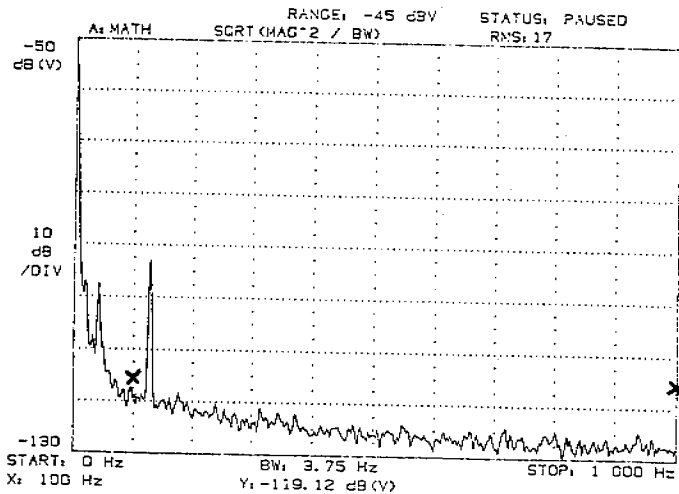

Figure 4c

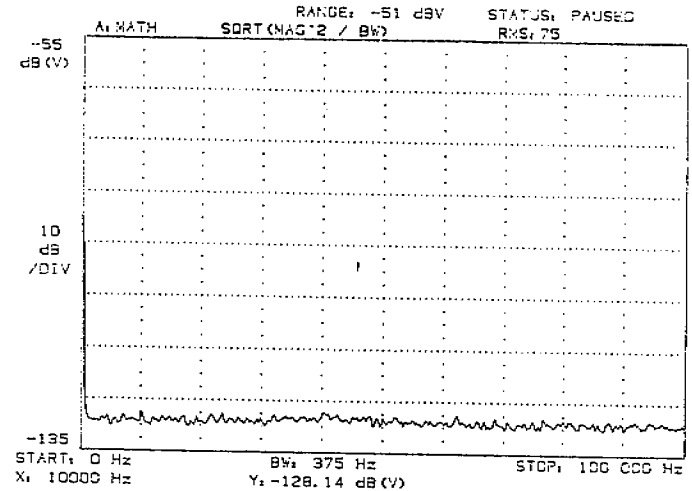

Figure 4d

Test Gain ~ 30 dB

X Phase noise spec.
Spur spec. off chart

Figure 4. 10 MHz FRK-LN Phase Noise Measurement