

ENVIRONMENTAL TESTS OF CESIUM BEAM FREQUENCY STANDARDS AT THE FREQUENCY STANDARDS LABORATORY OF THE JET PROPULSION LABORATORY*

Richard L. Sydnor, Thomas K. Tucker,
Charles A. Greenhall, William A. Diener, and Lute Maleki
California Institute of Technology
Jet Propulsion Laboratory
4800 Oak Grove Drive
Pasadena, California 91109

Abstract

Tests of the effect of various environmental parameters on HP 5061B, option 004, cesium beam frequency standards have been made at the test facilities of the Frequency Standards Laboratory at JPL. These standards were on loan from the United States Naval Observatory for these tests as a part of a larger cooperative program of testing and adjustment of cesium beam frequency standards between the United States Naval Observatory, National Institute of Standards and Technology, Jet Propulsion Laboratory and the University of Ancona. The environmental parameters of interest include humidity, ambient pressure and temperature. Marked sensitivity to humidity was found in all the standards, but the sign of frequency change vs relative humidity was not the same in all standards. The results of all the tests will be given and plans for future work under this program will be discussed.

INTRODUCTION

Purpose:

The tests described herein were performed by the Jet Propulsion Laboratory (JPL) in cooperation with the United States Naval Observatory (USNO) JPL was chosen for this evaluation because of its unique testing capability and facilities. They were conducted at JPL in the Frequency Standards Laboratory Test Facility (FSL) in Pasadena, California, between June and September 1989.

*This work represents the results of one phase of research carried out at the Jet Propulsion Laboratory, California Institute of Technology, under contract with the National Aeronautics and Space Administration.

Test Facilities:

The JPL Frequency Standards Laboratory is responsible for the research, development and implementation of a wide variety of state-of-the-art frequency generation and distribution equipment used within the Deep Space Network (DSN). In order to achieve the demanding performance and reliability requirements, a substantial amount of assembly and subassembly testing is required. Toward this end, an extensive testing capability has been developed which includes special equipment, facilities, procedures and personnel skilled in the testing and characterization of precision oscillators and other signal sources and signal processing equipment. This facility has previously described in the literature^[1].

The stability and environmental tests which are routinely performed in this facility are as follows:

1. Allan Variance
2. Spectral Density of Phase
3. Temperature Sensitivity
4. Humidity Sensitivity
5. Barometric Pressure Sensitivity
6. Magnetic Field Sensitivity (both AC and DC)
7. Vibration Sensitivity (0.1 to 30 Hz, small items).

The instrumentation and test area has approximately 2,700 square feet of floor space, and houses the necessary instrumentation and test equipment. Additionally, two or more active hydrogen maser frequency references are conveniently located in this area. Several cesium standards and clocks are used for calibration to NIST and/or USNO. A GPS receiver is used to maintain these standards and clock calibrations. All critical equipment as well as the units under test are powered by an uninterruptable power source. The entire test area, as well as the environmental control system is backed up by an automatically switched motor generator. Temperature control is maintained to within ± 0.05 degrees Centigrade through the use of a doubly redundant air conditioning system. Magnetic field variations are minimized by the use of non-magnetic construction materials throughout the facility. As an additional precaution, one of the reference hydrogen masers is housed in a magnetically shielded enclosure.

Parameter	Range
Temperature	15 to 35 deg. C ± 0.05 deg.
Pressure	± 24 inches of water ± 0.5 inches.
Relative Humidity	11% to 90% RH $\pm 5\%$
Magnetic Field	± 0.5 Gauss

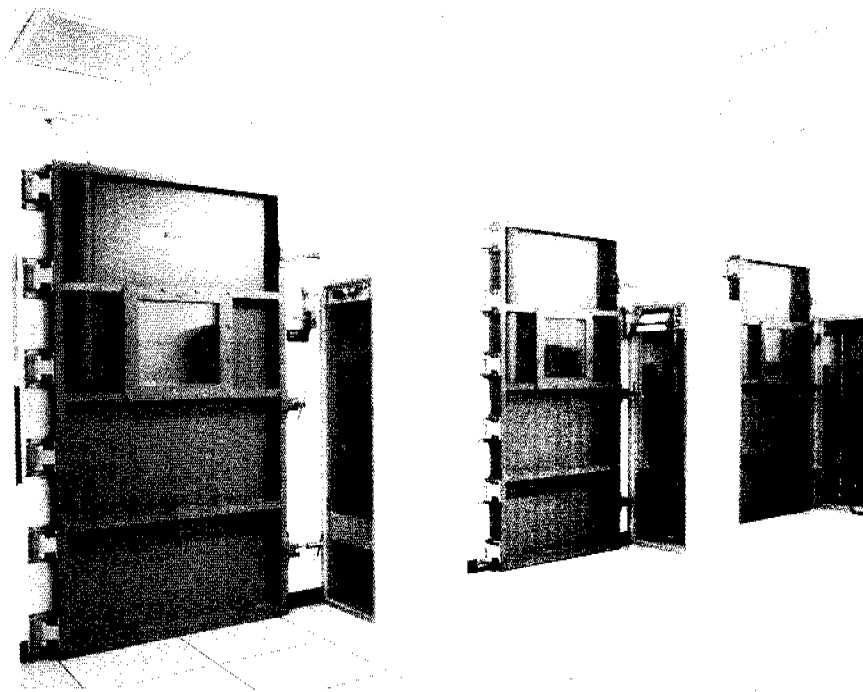

Figure 1: Environmental Test Chambers

Environmental testing capability is provided by the three custom-built Tenny Corporation environmental test chambers shown in Figure 1. Each chamber has 64 square feet of floor space and is approximately 10 feet high, providing adequate space for the equipment under test as well as required cables and peripherals. The capability of these chambers is shown in Table 2:

Measurement System

Figure 2 is a block diagram of the measurement system used to determine frequency stability and the Allan deviation between the units under test and the laboratory reference masers.

TEST SCHEDULE

Preliminary Tests

Prior to performance and environmental testing, and after several days of stabilization, each of the cesium standards was degaussed and aligned in accordance with the manufacturers operating procedures. The critical operating parameters of each of the standards was measured and determined to be within the manufacturers specifications. Shortly after the tests were begun, Cesium Standard Number 1 failed. The tests were continued with Standards Numbers 2, 3 and 4.

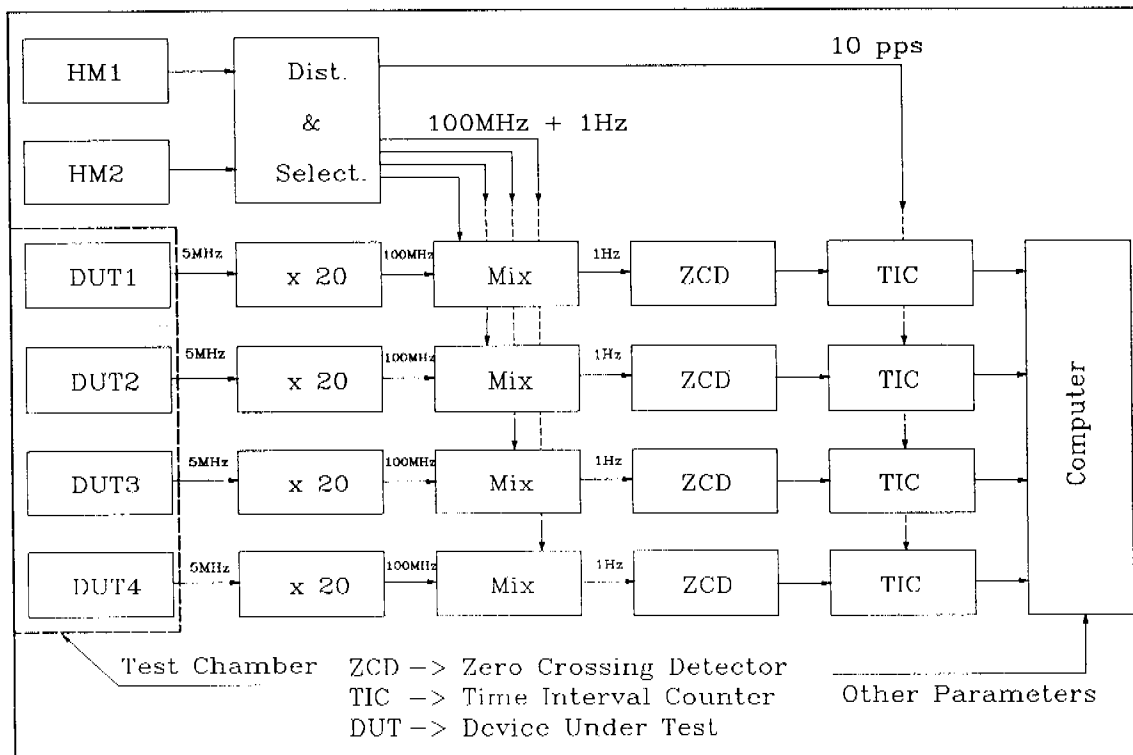

Figure 2: Block Diagram of Measuring System

Sequence of Tests:

The test schedule and test limits are shown Table 3 and Figure 3:

Table 3. Test Ranges	
Parameter	Range
Temperature	17 to 33 Deg. C
Humidity	15% to 85% RH
Barometric Pressure	±24 inches of water

Environmental Tests:

The purpose of these tests was to characterize each cesium beam frequency standard in terms of frequency shift for a given change in environmental condition. In each test, the output frequency was carefully monitored while one of the environmental parameters was varied as specified in Table 3 and Figure 3. The results of each of these environmental tests are shown in Figures 4, 5, 6, 7, 8, 9, 10, 11 and 12.

Figures 4, 5, and 6 show the changes in frequency from standards number 2, 3, and 4 respectively vs changes in relative humidity at four constant temperatures; 17, 22, 27 and 33 °C. The four humidity

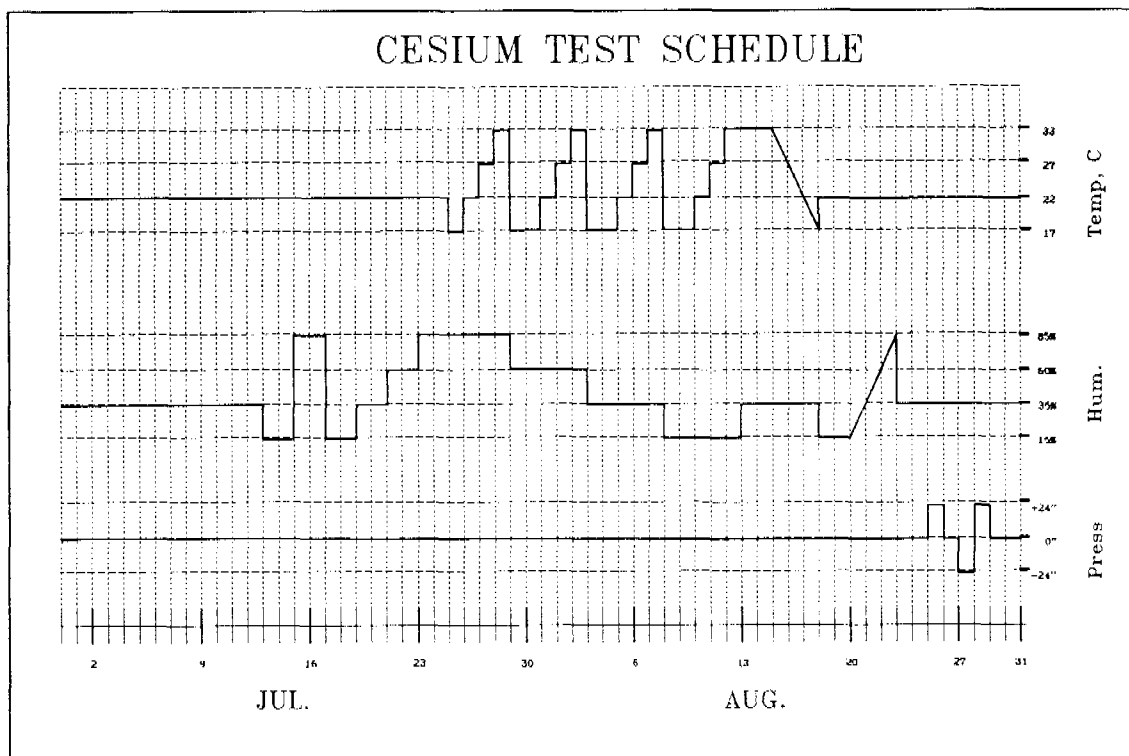

Figure 3: Schedule of Tests

levels which were used were 15%, 35%, 60% and 85%. We note that the changes in frequency are as large as 4×10^{-13} for standard number 2 and somewhat smaller for the other two standards. We also note that the changes in frequency were much smaller at the lower temperatures for the same change in relative humidity. This led us to believe that the important parameter might be the total water content of the ambient air, so the data was re-plotted in Figures 7, 8 and 9.

The results of Figures 7, 8 and 9 are much more readily interpreted than those of Figures 4, 5 and 6. For Cesium Standards numbers 2 and 3, a clear trend is seen in the frequency vs water content, with the frequency decreasing with increasing water content. Cesium standards number 4 has a much more anomalous behavior which also depends on temperature, with a turn-over temperature of approximately 30 °C.

The tests shown in Figures 10, 11 and 12 are taken by varying the temperature while the relative humidity was held constant. Again, we see that the lower humidity produces less frequency change over the temperature range than higher humidity does. The frequency changes can be as high as 4×10^{-13} for the standards.

The frequency changes vs pressure produced no significant changes, and were below the level of uncertainty of these tests.

CONCLUSIONS

These data demonstrate that, if the ultimate stability is to be obtained from this type of cesium frequency standards, not only must the temperature be controlled to a level of $\approx \pm 0.1$ °C, but control of humidity is essential. It appears that, at a nominal relative humidity of 35%, the humidity control must maintain a stability of $\approx \pm 5\%$.

FUTURE PLANS

The second and third phases of this test program, i.e. the adjustment for minimum power dependence and re-testing, have not been scheduled yet. Scheduling any series of tests entailing this length of time among three different bureaucracies are, at the best, difficult. It appears that a better sequence of tests might be arranged, based upon what was learned from this preliminary experiment. The variation of frequency *vs* temperature at constant relative humidity should have been performed at constant water content to give more meaningful results.

ACKNOWLEDGEMENTS

The authors wish to acknowledge the cooperation of G. M. R. Winkler and L. Charon of the U. S. N. O. for the use of the Cesium Standards for use in this test. The encouragement of Andea Di Marchi was the spark that caused the fruition of this experiment.

REFERENCES

- [1] Sydnor, R. L., "Environmental Testing at the Jet Propulsion Laboratory's Frequency Standards Laboratory", Proc. of the 43rd Annual Symposium on Frequency Control, IEEE 89CH2690-6, 31 May-2 June, 1989, pp 289-295

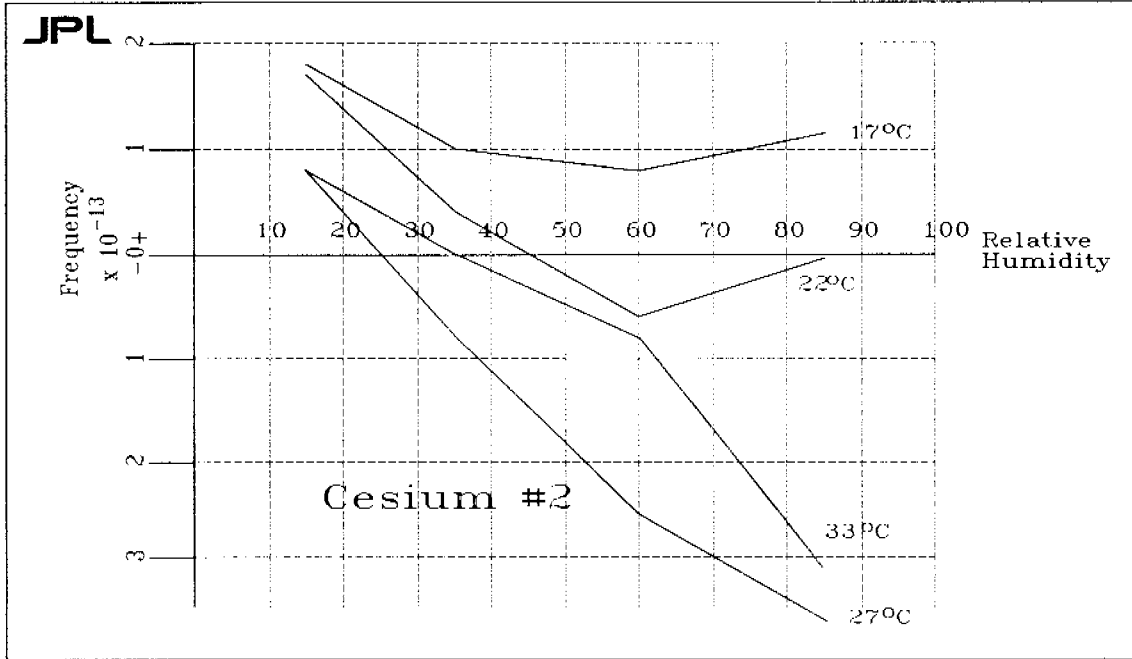

Figure 4: Frequency vs Relative Humidity, Constant Temperature, Cesium # 2

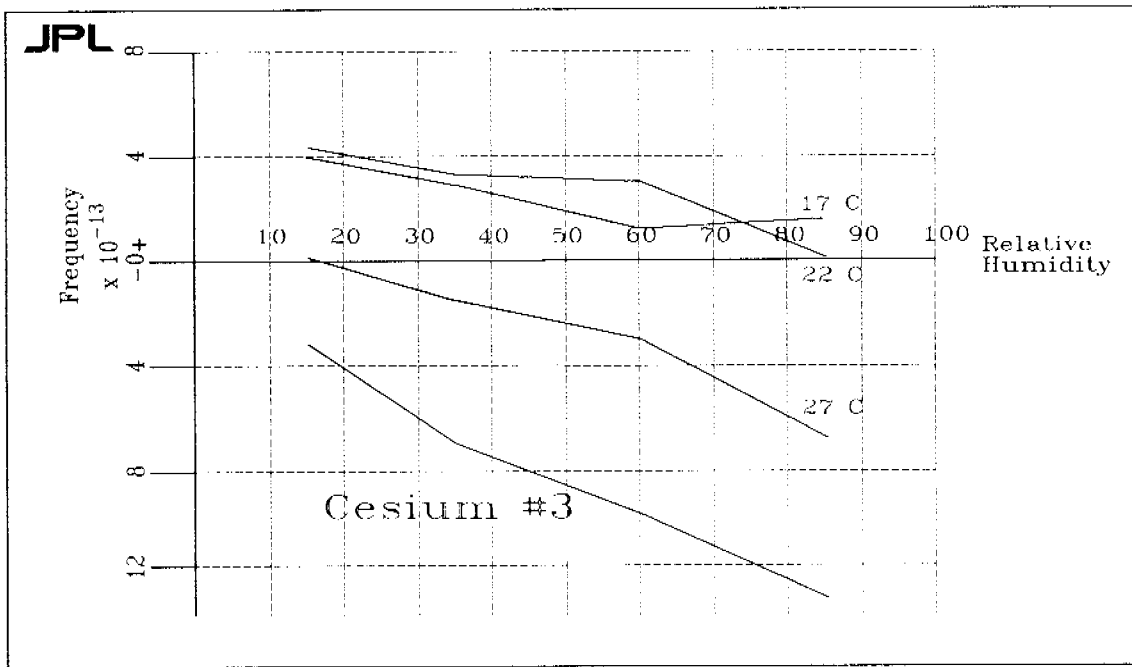

Figure 5: Frequency vs Relative Humidity, Constant Temperature, Cesium # 3

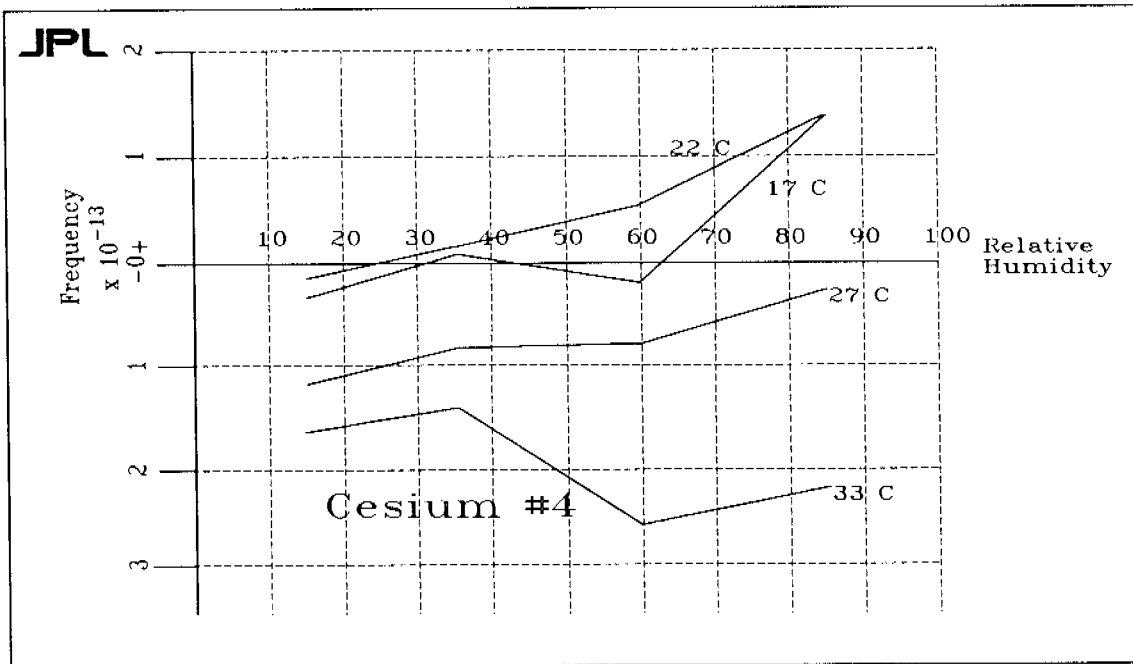

Figure 6: Frequency vs Relative Humidity, Constant Temperature, Cesium # 4

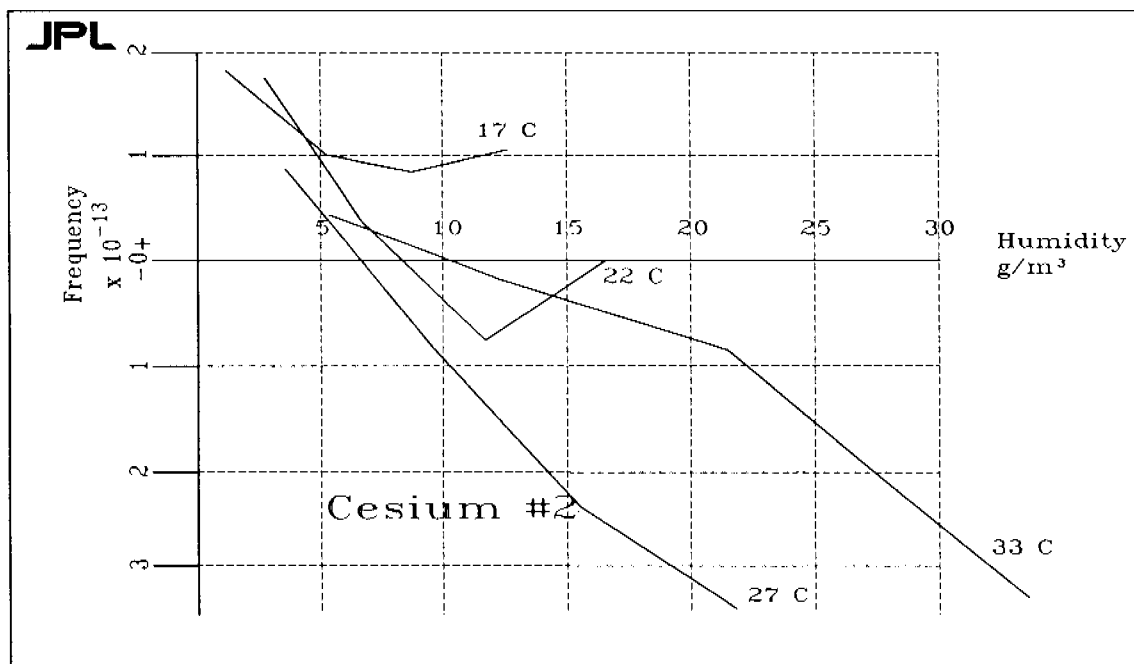

Figure 7: Frequency vs Absolute Humidity, Constant Temperature, Cesium # 2

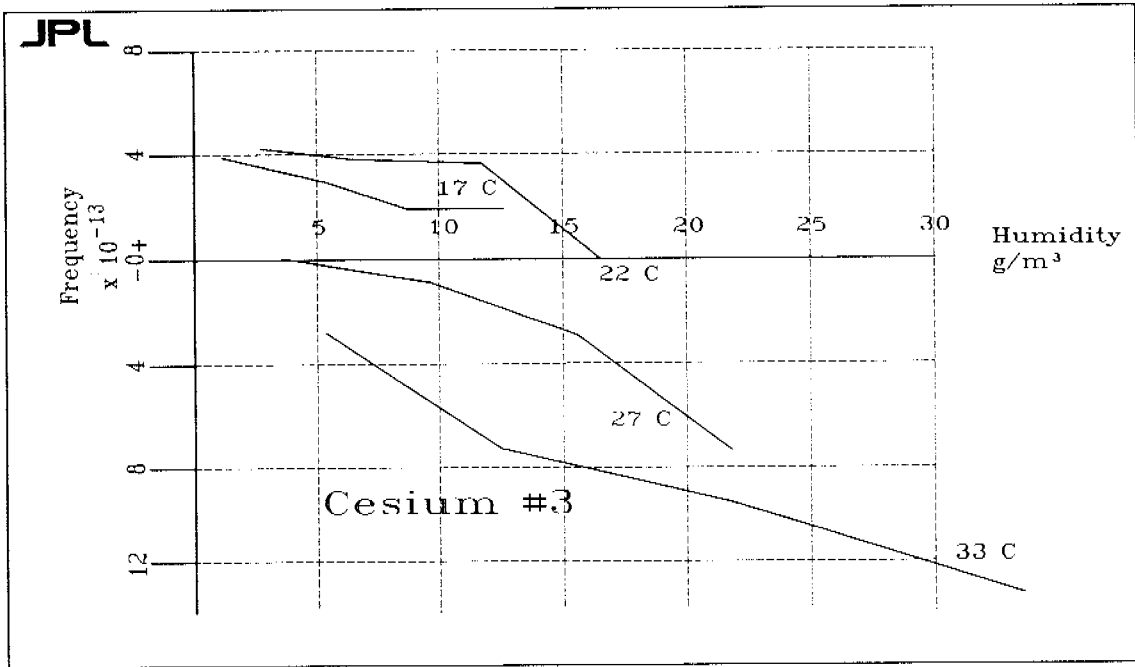

Figure 8: Frequency vs Absolute Humidity, Constant Temperature, Cesium # 3

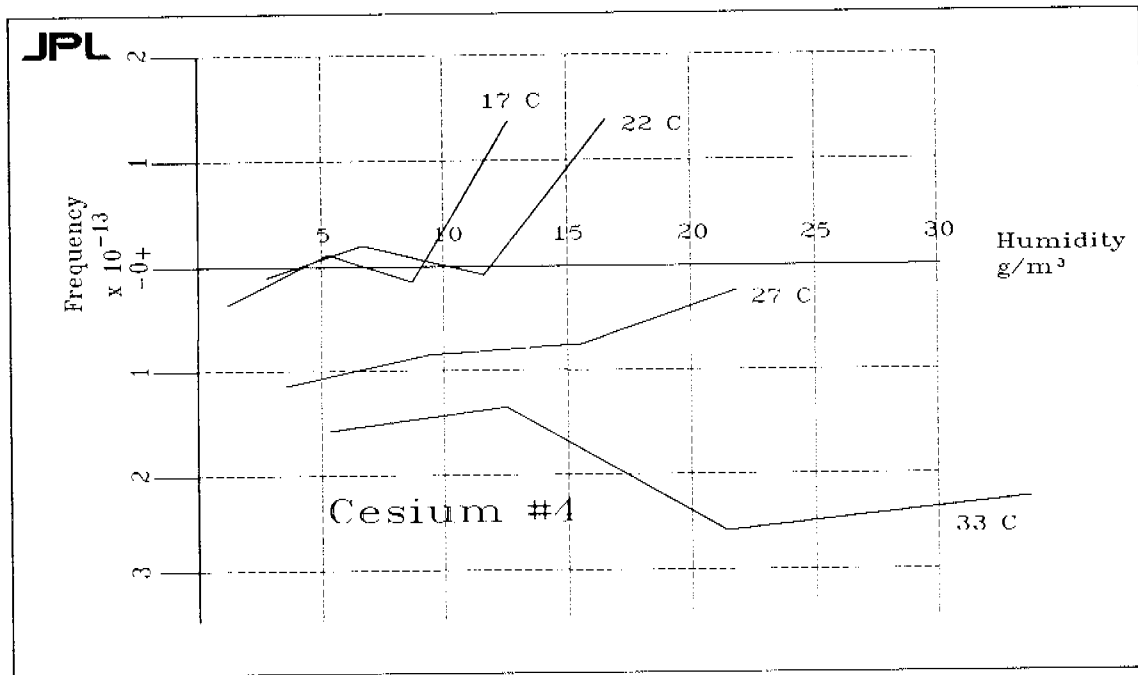

Figure 9: Frequency vs Absolute Humidity, Constant Temperature, Cesium # 4

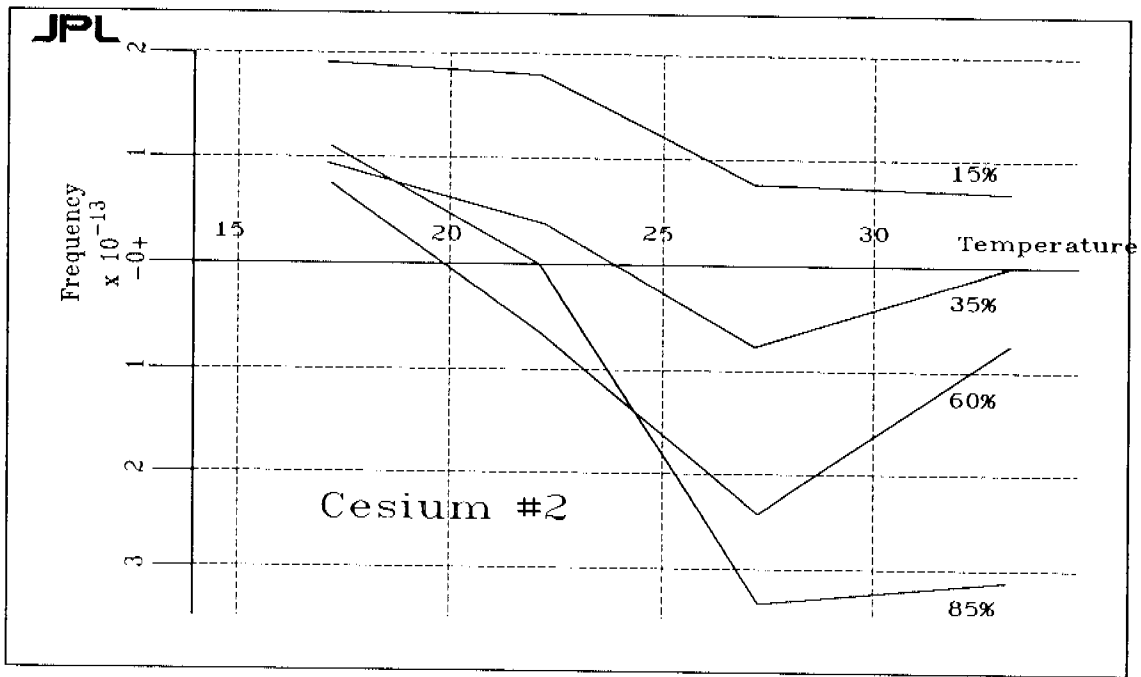

Figure 10: Frequency vs Temperature, Constant Relative Humidity, Cesium # 2

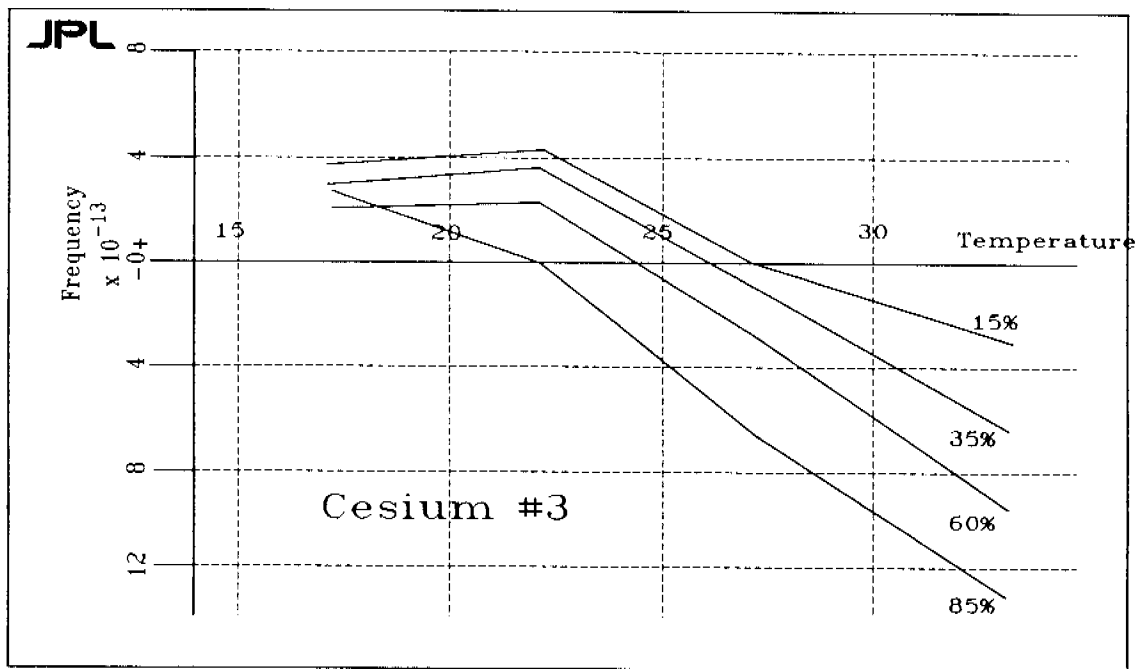

Figure 11: Frequency vs Temperature, Constant Relative Humidity, Cesium # 3

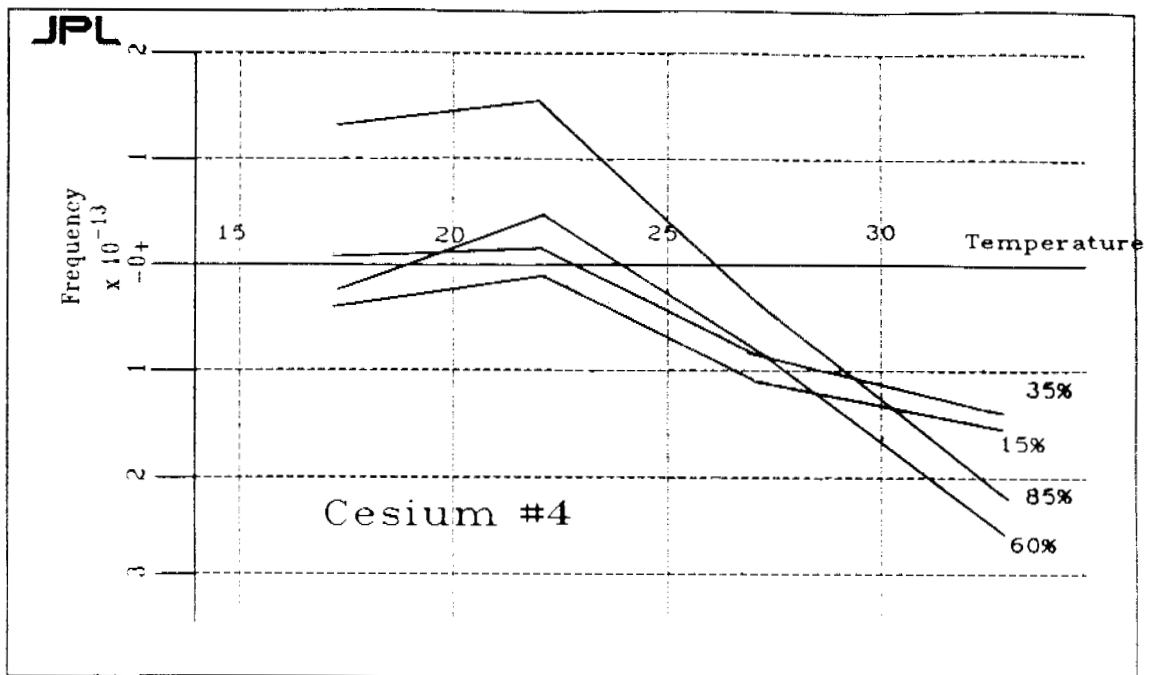

Figure 12: Frequency vs Temperature, Constant Relative Humidity, Cesium # 4

QUESTIONS AND ANSWERS

ROBERT VESSOT, SAO: It is easy to put these in a plastic bag with a bag of silica gel, I suppose. That would get rid of the bulk of the problem, but it would be interesting to know what you think is going on in there.

LEN CUTLER, HP: Two things, probably. Power shift and resonance affects on the cavity tuning.

MR. SYDNOR: Professor Leschiutta took some data and he got an indication that the integrator board was sensitive, also.

MR. REINHARDT: We have seen similar effects in other standards. The very high impedances in servo boards can be affected.

MR. CUTLER: That is certainly possible. It is hard for me to say, but in the original designs, those circuits were all guarded. They should have been very resistant to humidity changes.

MR. SYDNOR: There is another interesting bit of information—if you look at humidity effects in hydrogen masers, there is a long time constant associated with them. It may take several days for the effect to take place. The effect on these cesiums was nearly instantaneous. It doesn't appear to be absorption of moisture into a circuit board.

JACQUES VANIER, NRC: This is to Len Cutler. How does the humidity affect the cavity tuning?

MR. CUTLER: It is actually an interaction between power shift and cavity tuning. If the cavity is properly tuned and doesn't change with humidity, then power shift doesn't affect things very much. If the cavity is de-tuned then power shift will affect it.

MR. VESSOT: The tuning is a result of the dielectric effect of the humidity, I assume.

MR. CUTLER: That can affect it, yes.

MR. VESSOT: Would it have made sense to change the barometric pressure? That would change the density and the dielectric constant.

MR. SYDNOR: We did change pressure at constant humidity and temperature. We couldn't see any effect, it was in the noise. Of course, the pressure change was not huge, it was ± 24 inches of water—like a big storm.

MR. REINHARDT: One thing that I would recommend is to monitor the loop stress because you have a frequency locked loop and the oscillator may be changing.

ANDREA DI MARCHI, UNIVERSITY OF ANCONA: I think that some of these questions may be answered if we set these standards at the power insensitive point and then do the tests again.

MR. SYDNOR: That was the original plan.