

MAINTENANCE OF TIME AND FREQUENCY IN THE
JET PROPULSION LABORATORY'S DEEP SPACE NETWORK
USING THE GLOBAL POSITIONING SYSTEM

by

P. A. Clements, S. E. Borutzki, and A. Kirk

Jet Propulsion Laboratory
California Institute of Technology
Pasadena, California

ABSTRACT

The Deep Space Network (DSN), managed by the Jet Propulsion Laboratory for NASA, must maintain time and frequency within specified limits in order to accurately track the spacecraft engaged in deep space exploration. The DSN has three tracking complexes, located approximately equidistantly around the earth. Various methods are used to coordinate the clocks among the three complexes. These methods include Loran-C, TV Line 10, Very Long Baseline Interferometry (VLBI), and the Global Positioning System (GPS). The GPS is becoming increasingly important because of the accuracy, precision, and rapid availability of the data; GPS receivers have been installed at each of the DSN complexes and are used to obtain daily time offsets between the master clock at each site and UTC (USNO/NBS). Calculations are made to obtain frequency offsets and Allan variances. These data are analyzed and used to monitor the performance of the hydrogen masers that provide the reference frequencies for the DSN Frequency and Timing System (DFT). This paper contains: (1) a brief history of the GPS timing receivers in the DSN, (2) a description of the data and information flow, (3) data on the performance of the DSN master clocks and GPS measurement system, and (4) a description of hydrogen maser frequency steering using these data.

I. INTRODUCTION

The Deep Space Network (DSN), managed by the Jet Propulsion Laboratory for NASA, is a network of three complexes of antennas used to track spacecraft. These complexes are located approximately equidistantly around the earth at Goldstone, California; Canberra, Australia; and Madrid, Spain. Each of the complexes contains a frequency and timing system which provides the required frequencies and timing pulses throughout the complex. These three subsystems are a part of a network-wide DSN Frequency and Timing System (DFT).

The process of tracking spacecraft engaged in deep space exploration requires a highly accurate and stable timing system. Navigation parameters such as spacecraft range and relative velocity are obtained by measuring a radio signal's round-trip light time and the doppler frequency shift of the received signal. Since the long spacecraft distances involved result in long round-trip light times, one complex may need to hand over tracking to the next complex before these measurements are completed. In addition, Very Long Baseline Interferometry (VLBI) and the ongoing study of radio signal perturbations due to various causes (planetary occultations, solar wind electron density fluctuations, gravitational waves, etc.) necessitates further requirements for a highly synchronized and syntonized DFT.

Presently, DFT requirements are to maintain time to within ± 20 microseconds with a knowledge of ± 10 microseconds, and to maintain frequency to within $\pm 1 \times 10^{-12} \Delta f/f$ with a knowledge of $\pm 3 \times 10^{-13} \Delta f/f$. In addition, time synchronization must be maintained between the DSN and Universal Coordinated Time (UTC) to ± 20 microseconds, with a knowledge of ± 5 microseconds (see Fig. 1). The anticipated need of the DSN for 1986-1990 is for time synchronization of 10 nanoseconds between the stations (Ref. 1). While this may not be realizable, it seems possible to have knowledge of the time offset to within 10 nanoseconds. In general, the DFT should be able to provide a value of time and frequency offset for any given past date. (Date is defined here as a specific point on a time scale; e.g., 1 January 1972, 0 h, 0 m, 10 s UTC is a date on the UTC time scale.) Therefore, the DFT must continually estimate the time and frequency offsets as well as keep past estimates and data archived.

II. FREQUENCY AND TIMING CONTROL SYSTEM DESCRIPTION

Historically, the DFT has consisted of three fairly independent systems, each located at one of the three complexes. Various traditional methods (clock trips, VLBI, and Loran-C) were used in an attempt to keep these three systems synchronized and syntonized with respect to each other. In 1983, using the GPS timing receivers, a tighter control system was designed (see Fig. 2). The system consists of GPS measurements, an analysis of the output of daily offsets, and, if needed, a frequency adjustment and/or clock reset. Using the GPS receivers, the DFT is capable of identifying changes in frequency on the order of $1 \times 10^{-13} \Delta f/f$ in a matter of a few days.

The GPS receivers are queried weekly and a TWX message is issued with the calculations of time and frequency offset. The time offset of the Goldstone complex with respect to UTC realized at the National Bureau of Standards

[UTC (NBS)] is obtained from NBS so that a calculation of the other complexes with respect to UTC (NBS) can be made. The information is distributed about a week later. These data, as well as VLBI, Loran-C, and other measurements, are used to determine what action should be taken to keep the master clocks within their specified operating parameters.

III. GPS INSTALLATION AND COORDINATION

In 1982, JPL installed two GPS timing receivers in the DSN. The receivers were located in Goldstone, California and Madrid, Spain. The results of this installation were reported in the Proceedings of the 14th Annual Precise Time and Time Interval Applications and Planning Meeting (Ref. 2). Mutual view observations were made and the time offsets were compared to those offsets derived from VLBI measurements. (In the mutual view technique, two or more receivers take time offset data from a spacecraft at the same time; ideally, the elevation of the spacecraft above the horizon is the same when viewed from all of the receivers involved.)

In 1983, a receiver was installed at the Deep Space Station near Canberra, Australia. The plan was to use the Madrid receiver in Australia and provide only a single leg again, but the Madrid receiver proved so useful it was decided to lease a receiver from NBS so the two JPL-owned receivers could be deployed overseas. By early 1983, JPL had an operating worldwide network of GPS receivers. The primary 1983 effort was to evaluate the California-Australia line. The results of this effort were reported in the 15th Annual Precise Time and Time Interval Application and Planning Meeting (Ref. 3). Because of the great distances involved, both mutual view and flyover techniques were used, and comparisons were made using both VLBI and clock trips.

The GPS timing receivers at the complexes receive a timing pulse from the station's master clock, which is referenced to station time by the receiver. Each of these receivers has a modem attached which may be queried remotely; at JPL a Hewlett Packard desk calculator (HP 9845) interfaces to a modem. (In the continental United States the regular phone system is used to query the receivers; the intercontinental queries are made using the voice communication system operated by NASA.) This calculator is used to store the receiver data on tape and to generate the weekly report of time offsets between the station clocks and between Goldstone and UTC (NBS).

JPL uses the NBS time coordination service (Ref. 4) to relate the station time at Goldstone, California to UTC (NBS). These data are obtained in two forms--NBS provides a monthly report, and daily offsets are available by telephone from a computer at NBS. The NBS service provides the raw measurement data, a daily filtered estimate, a monthly filtered estimate, Allan variance plots, and other useful data about the performance of the JPL clock. This service eliminates the technical need for regular clock trips between JPL and NBS. The regular clock trips are still maintained, but they may be eliminated as operational confidence is gained in the performance of the GPS timing receivers.

In order to ensure that a time and frequency offset can be estimated for any past date, all of the data taken from the receivers are archived. Presently, the data accumulation rate amounts to about 2 megabytes per year. It is

estimated that a maximum rate would be 6 to 8 megabytes per year. This small amount of data is easily handled by a personal computer, while several years of data can be stored on a hard disk and backed up using either flexible diskettes or magnetic tape.

All of the data presented in this paper were taken using the common view technique. For the data taken between Goldstone, California and NBS (located at Boulder, Colorado), the elevation angles of the spacecraft were above 60 degrees. The Goldstone, California to Madrid, Spain angle was usually 40 to 45 degrees elevation--still quite high above the horizon. On the other hand, the mutual view between Goldstone, California and Canberra, Australia was approximately 18 degrees above the horizon, which presents a substantial problem with respect to variations in group delay due to the earth's atmosphere. While these problems could be largely overcome by using a flyover or long-arc technique (Ref. 3), because of computational difficulties, this method was not used as a normal procedure in 1984.

As Fig. 3 demonstrates, the application of a Kalman smoother filter substantially improves the standard deviation for shorter sampling times on the short baseline (less than 1000 km) between Boulder, Colorado and Goldstone, California. The longer baselines between California and Spain and between California and Australia promise to show the same sort of improvement with the application of appropriate Kalman smoothers.

Fig. 4 shows a comparison of the Allan variance of the data between California and Australia and California and Spain. At 8 days both of the standard deviations are near in value to that of the shorter Boulder-Goldstone baseline. Presumably, the greater amount of noise associated with the California to Australia measurement is caused by the low observation angles. An analysis shows a substantial amount of white phase noise, which implies that a Kalman smoother should help considerably.

IV. ANALYSIS

The synchronization and syntonization of the DSN master clocks is accomplished by analyzing the time offset data obtained from all available sources. These sources include the GPS, VLBI (interstation), Loran-C (Goldstone and Madrid), TV line 10 (Canberra), and the local backup clocks at each station. (Time offset rates are also obtained from the GPS and VLBI measurements, but are not discussed in this paper.) These unfiltered time offset data and the data provided by the NBS Time and Frequency Bulletin, the USNO Series 4 Bulletin, and NATMAP Bulletin E are entered into a computer database at JPL. Any events, whether occurring at the station, NBS or USNO, are noted in the data files.

Estimates of frequency offsets for the clocks with respect to each other and to UTC (NBS/USNO) are made on a regular basis. These offsets are calculated by a least-squares linear fit on segments of the raw time offset data. The average time offset rate over the length of the fit segment is taken to be the relative frequency offset between the clock oscillators. The standard deviation of linear fit residuals is also calculated to determine the confidence of the calculation. Second-order effects (frequency drift) are estimated by the changes in the average time offset rate over a period of time; this is more

difficult to determine because it requires relatively long periods of unperturbed clock operation. Because there have been both explainable and unexplainable perturbations in the hydrogen maser operating frequency at all of the stations, accurate determination of frequency drift has not yet been possible.

The results of the measurements and calculations are studied to determine how the master clocks are performing with respect to the specification requirements. All known events are taken into account for this appraisal. For any unexplained time steps or frequency shifts, the station personnel are asked to provide any additional information which may help to uncover the reason for the behavior. Based on all of this information, time and/or frequency adjustments are proposed.

The decision to change the output frequency of a hydrogen maser is made by JPL personnel in charge of the standards. The method and the procedures to offset the frequency by the desired amount are determined using the history of that particular maser. The station activity schedule is consulted to find a time when there will be minimal impact on operations, then a TWX containing information on the proposed adjustment is issued to the station and to interested JPL personnel. This TWX includes a brief summary of the performance which prompted the action, the instructions for accomplishing the frequency adjustment, and the station clock reset instructions (if any). After the work has been completed, the station confirms the operation by TWX. The clock performance is watched closely after the procedure to determine hydrogen maser adjustment parameters and verify accuracy.

The results of the maintenance of time and frequency in the DSN using the GPS may be seen in the time offset data shown in Figs. 5 through 8. The particular timespan chosen (December 11, 1983 through June 28, 1984) is representative of what has been accomplished with this system. All events and the results of the linear fits on the time offset data are presented in Tables 1 through 3. [UTC (NBS) was chosen as a reference so that the events at each station may be seen more clearly.] As is evident from the data, the hydrogen maser frequency standard clock at each complex has been maintained to within the synchronization and syntonization requirements with respect to both an external time scale and to the other clocks in the DFT.

One goal in the implementation of the GPS was to allow more stringent frequency controls on each hydrogen maser. The results of four planned frequency adjustments may be seen in Table 4. As is discussed under clock correction methods, only a synthesizer adjustment will vary the operating frequency by a precisely known amount. Therefore, the results seen in the table were considered successful.

Of particular interest to JPL hydrogen maser standards personnel is the sensitivity of the standards to environmental changes in the field. The parameters most likely to vary and cause a disturbance are room temperature and the local magnetic field. Although the Deep Space Stations provide a controlled environment, there are occasional disturbances which are either unforeseeable or unavoidable. The events occurring at Goldstone on the 75th day of 1984 (84075) and at Madrid (84080) are examples of this. There was an unplanned temperature increase in the maser room at Goldstone, accompanied by

extensive equipment movement in the adjoining room, which may have affected the magnetic environment. At Madrid, a modification kit was installed in the maser and a cesium clock was removed from a neighboring rack. There was also some activity in the room in Canberra which may have affected maser behavior, although the effects are not as definite. As more data are collected and correlated to the changes in the operating environment, effects can be predicted and appropriate steps can be taken to prevent disturbances. Planned upgrades to the frequency standards rooms and more strictly limited access to these areas will improve these situations.

The maser failure in Madrid (84054) is fortunately a relatively rare occurrence. In this case, the problem was found to be a marginally low hydrogen pressure setting. After the pressure was increased, the maser returned to normal operation with no frequency change. Currently, the DSN has only one hydrogen maser at each site; backup is provided by a cesium standard. An additional hydrogen maser is planned for each location, and this will minimize the impact to data quality in the event of a prolonged maser failure.

The behavior of the hydrogen maser in Canberra is least understood. During this timespan there were no known events which would have produced frequency changes except for the frequency adjustments at NBS. This particular maser had undergone work at the Smithsonian Institution Astrophysical Observatory (SAO) and was returned to the station on 83320. From the GPS data, it appears to have decreased in frequency until approximately 84120. (In the past, the usual aging rate seen in an SAO maser was $+3$ to $+5 \times 10^{-15}$ /day.) Even with a frequency aging rate of only $+1 \times 10^{-15}$ /day, the frequency offset should have reached zero in about 60 days. But the time offset data and the associated linear fits show that it took approximately 150 days for this to happen, which would correspond to an aging rate of only $+0.4 \times 10^{-15}$ /day. When the NBS adjustments are taken into account (they were made in the negative direction for the most part), they show an even lower aging rate for the Canberra maser. Table 5 shows the relative frequency offsets when the NBS changes are removed. The results of this calculation show that the maser is not exhibiting the usual aging seen in this type of maser, at least not during this time period. It is possible that aging effects are appearing after 84122, but it is difficult to determine without comparison to another external standard.

The relative frequency offsets obtained by the calculations described above are complicated by several factors. First, it is essential that all time steps must be properly noted so that a fit is not made over any discontinuities. Second, the fit timespans must be chosen carefully so that misleading information is not obtained because of frequency shifts. Both the low and high frequency noise on the data will cause different frequency offset results, depending on the period chosen for the fit (see footnote 2, Table 2). This is especially important when determining the effects of any environmental changes on the operating frequency. There are situations where no cause can be found to explain a change in the maser frequency (such as the case in Madrid after the frequency adjustment on 84146) but the data cannot be included as part of the previous fit segment. Future GPS time synchronization

data should make it possible to see the more subtle changes in the behavior of a hydrogen maser. This information will allow more detailed analysis, leading to the development of a more accurate time and frequency system to meet more demanding future requirements.

V. FREQUENCY ADJUSTMENT METHODS

An important parameter when using the hydrogen maser to drive the complex clock is its long-term stability (over several months). Due to cavity aging, most hydrogen masers have a small amount of long-term drift; drift due to a change in wall shift may add to or cancel part of the cavity drift. In addition, there are perturbations to the output frequency that are caused by changes in the ambient temperature, magnetic field, barometric pressure, humidity, etc. Constant monitoring and precise control of the maser's environment are essential to meet the DFT specifications.

Once a maser is installed in its environment, the magnetic field bias and receiver offset synthesizer are set to previously determined calibration values. The maser cavity is then carefully tuned by the spin exchange method and the frequency offset from UTC (NBS) is measured. The cavity frequency is then offset by a specified amount in the opposite direction of the drift (Fig. 9). This not only maximizes the frequency correction interval but also maintains the best average cavity frequency. Constant monitoring will then determine if nonscheduled frequency corrections are required.

The output frequency of a hydrogen maser may be changed by (1) cavity frequency adjustment, (2) receiver synthesizer offset adjustment, and (3) magnetic field bias adjustment. The range and resolution of the magnetic field adjustment are adequate to steer the output frequency. This adjustment is generally not used for this purpose because of its difficulty. Rather, an optimum magnetic field bias is initially determined and maintained for calibration. This adjustment offsets the hydrogen line frequency.

The receiver offset synthesizer adjustment is easily performed and does not disturb continuous operation of the maser if done in small increments (no phase steps are introduced). Resolution and range varies among maser types. The synthesizer is used to initially calibrate the maser's output frequency. Depending on the various systematic frequency offsets such as wall shift, each maser will have a unique synthesizer calibration setting. This adjustment offsets the receiver output from the hydrogen line frequency.

The cavity frequency adjustment is easily performed in the field and continuous operation of the hydrogen maser is not affected. Resolution is 2×10^{-16} to 2×10^{-14} , depending on the maser type. Range is 1×10^{-10} to 5×10^{-10} . Frequency change is instantaneous with varactor types or has a 5- to 24-hour time constant with thermal types. The cavity adjustment has a pulling effect on the line frequency (pulling factor $Q\text{-cavity}/Q\text{-line}$).

As previously mentioned, the cavity is initially tuned by the spin exchange method and the hydrogen maser is calibrated. Subsequent changes in hydrogen maser output frequency have been found to be due primarily to cavity aging and environmentally induced cavity shifts. Thus, it makes sense to correct a maser's frequency by readjusting the cavity only.

During 1984, the method described above was used to steer the hydrogen maser with reference to UTC (NBS) using the GPS. Spin exchange tuning was performed about once a year in order to determine total cavity shift and long-term behavior of the hydrogen line with respect to UTC.

VI. PROBLEMS ASSOCIATED WITH THE PRESENT CONTROL SYSTEM AND PROPOSED SOLUTIONS

A major problem is caused by noise factors and associated inaccuracies in the data. The GPS timing measurements have noise associated with them for several reasons. First, there is well-known noise that is intrinsic to the GPS (such as ephemeris errors, ionospheric errors, etc.). In addition, there is noise caused by the operation of the receivers; i.e., poor estimates of time offset are caused by an inexact mutual view, differences in elevation angles for the spacecraft at different receivers, and missing readings or readings averaged incorrectly. If a system of receivers is to be used to exploit the intrinsic accuracy and precision of the GPS, more accurate coordination among the receivers is required and more sophisticated analysis of the data is needed.

Over the course of the past year, about 20% of the days have had no GPS estimate of clock offset between the complexes provided by the GPS. The most common cause of missing data was power outages at the complexes. The receivers normally store less than a week's data in the failsafe memory, so if they are queried only once a week and there is a power failure, some of the data will probably be lost. The Goldstone receiver was relocated to a temporary location while major reconfigurations were being made at the Complex. This situation has now been changed and the receiver is presently in its permanent location, powered by an uninterruptible power system, as are the master clock and the frequency standards. It has become obvious that control must be improved over temperature and magnetic variations in the frequency standards environment. Security must be improved to limit personnel access to the area, and movement of equipment near the frequency standards.

VII. CONCLUSIONS

The GPS timing receivers have proven to be a cost-effective and reliable method to coordinate time and frequency to meet the requirements of the DSN. The performance of the master clocks was monitored on an almost daily basis. Frequency shifts and time jumps that were unexpected and in some cases unexplained were observed in the clocks. The hydrogen masers responded to frequency adjustments within the expected limits of knowledge of their performance behavior. Control of the time and frequency offset of the clocks was established to within the limits of the performance requirements of the DSN. It appears that with improved techniques the hydrogen maser master clocks can be controlled to much closer tolerances.

ACKNOWLEDGMENTS

The authors wish to thank the personnel at the DSN stations for their assistance in the implementation effort; specifically Sr. D. Munoz, Madrid, Spain; Mr. J. Myers, Goldstone, California; and Mr. J. Wells, Canberra, Australia. Also, thanks to Mr. D. Allan, Mr. D. Davis, and Dr. M. Weiss of NBS for their technical assistance.

This research was carried out by the Jet Propulsion Laboratory, California Institute of Technology, under contract with the National Aeronautics and Space Administration.

REFERENCES

1. P. F. Kuhnle and R. L. Sydnor, "Present and Future Frequency and Timing Capabilities of the Deep Space Network," Journal De Physique, Colloque C8, Supplement No. 12, December 1981, pg. 42.
2. P. A. Clements, "Global Positioning System Receivers in the DSN," Proceedings of the Fourteenth Annual Precise Time and Time Interval (PTTI) Applications and Planning Meeting, NASA Conference Publ. 2265, 1982.
3. J. McK. Luck, J. R. Woodger, J. E. Wells, P. Churchill, and P. A. Clements, "First Results of GPS Time Transfer to Australia," Proceedings of the Fifteenth Annual Precise Time and Time Interval (PTTI) Applications and Planning Meeting, NASA Conference Publ. 7962, December 6-8, 1983.
4. S. R. Stein, G. Kamas, and D. W. Allan, "New Time and Frequency Services at the National Bureau of Standards," Proceedings of the Fifteenth Annual Precise Time and Time Interval (PTTI) Applications and Planning Meeting, NASA Conference Publ. 7962, December 6-8, 1983.

Table 1. Goldstone versus UTC (NBS) Relative Frequency Offsets

Event	Timespan (YYDDD)	$\Delta f/f$ ($\times 10^{-13}$)	Sigma	Comments
	83345-84008	2.36	0.04	Start
1	84009-84011	6.41	0.30	Backup cesium standard online during maser frequency adjustment (spin exchange tune); time step due to switchover
2	84012-84030	0.13	0.05	Maser prime and clock reset
3	84030-84060	0.20	0.02	NBS frequency adjustment of $+0.88 \times 10^{-14}$
4	84061-84072	0.02	0.02	NBS frequency adjustment of -1.41×10^{-14}
5	84075-84091	2.58	0.12	Temperature change in maser room and equipment movement in adjoining room
6	84092-84113	2.81	0.07	NBS frequency adjustment of -2.31×10^{-14}
7	84115-84121	3.39	0.08	Maser maintenance in response to frequency change on DOY 75 (magnetic field bias adjustment); time step due to switchover
8	84122-84123	---	---	NBS frequency adjustment of -2.31×10^{-14}
9	84124-84152	5.65	0.04	GPS clock resynched to station clock (at this site only, the GPS uses a different frequency counter than the station)
10	84153-84163	6.68	0.10	NBS frequency adjustment of -2.31×10^{-14}
11	84167-84173	-1.33	0.06	Maser frequency adjustment (cavity) and clock reset

Table 2. Canberra versus UTC (NBS) Relative Frequency Offsets

Event	Timespan (YYDDD)	$\Delta f/f$ ($\times 10^{-13}$)	Sigma	Comments
	83346-84015	-0.61	0.03	Start
1	84033-84060	-1.34	0.05	NBS frequency adjustment of $+0.88 \times 10^{-14}$
2	84061-84091 ¹	-1.51	0.09	NBS frequency adjustment of -1.41×10^{-14}
3	84092-84121	-1.69	0.06	NBS frequency adjustment of -2.31×10^{-14}
4	84122-84152 ²	-1.22	0.05	NBS frequency adjustment of -2.31×10^{-14}
5	84153-84172 ¹	0.19	0.07	NBS frequency adjustment of -2.31×10^{-14}

¹Maintenance work was done on the backup cesium clock located in the same vicinity on days 83-86 and 157. The effect on the maser is unknown.

²The following is an example of how the results depend on the timespan chosen for the fit:

84122-84129	-0.86	0.17
84136-84141	-2.25	0.32
84146-84152	-0.49	0.44

Table 3. Madrid versus UTC (NBS) Relative Frequency Offsets

Event	Timespan (YYDDD)	$\Delta f/f$ ($\times 10^{-13}$)	Sigma	Comments
	83345-83360	7.19	0.04	Start
1	83364-84030	-0.15	0.04	Maser frequency adjustment (cavity) and clock reset
2	84033-84053	-0.08	0.10	NBS frequency adjustment of $+0.88 \times 10^{-14}$
3	84055-84060	---	---	Maser source failure; maser restarted and clock reset
4	84061-84072	-0.15	0.04	NBS frequency adjustment of -1.41×10^{-14}
5	84080-84091	1.34	0.10	Maser modification kit installed; cesium standard removed from nearby rack
6	84092-84121	2.76	0.14	NBS frequency adjustment of -2.31×10^{-14}
7	84122-84142	2.83	0.19	NBS frequency adjustment of -2.31×10^{-14}
8	84146-84152	-1.74	0.28	Maser frequency adjustment (cavity)
9	84153-84173	-0.23	0.05	NBS frequency adjustment of -2.31×10^{-14}

Table 4. Results of the Hydrogen Maser Frequency Adjustments
(Change in Relative Frequency with Respect to NBS)

Date (YYDDD)	Complex	Goal	Result ($\times 10^{-13}$)	Method of Adjustment
83362	Madrid	-8.5	-7.3	Cavity frequency
84009	Goldstone	-3.0	-2.2	Magnetic field, receiver synthesizer, and cavity frequency (spin exchange tune)
84144	Madrid	-5.0	-4.6	Cavity frequency
84166	Goldstone	-8.4	-8.0	Cavity frequency

Table 5. Effect of the NBS Frequency Adjustments on the
Canberra Hydrogen Maser Relative Frequency Offsets

Timespan (YYDDD)	NBS Adjustments Included $\Delta f/f$ ($\times 10^{-13}$)	NBS Adjustments Removed $\Delta f/f$ ($\times 10^{-13}$)
83346-84015	-0.61	-0.61
84033-84060	-1.34	-1.25
84061-84091	-1.51	-1.56
84092-84121	-1.69	-1.97
84122-84152	-1.22	-1.73
84153-84172	+0.19	-0.06

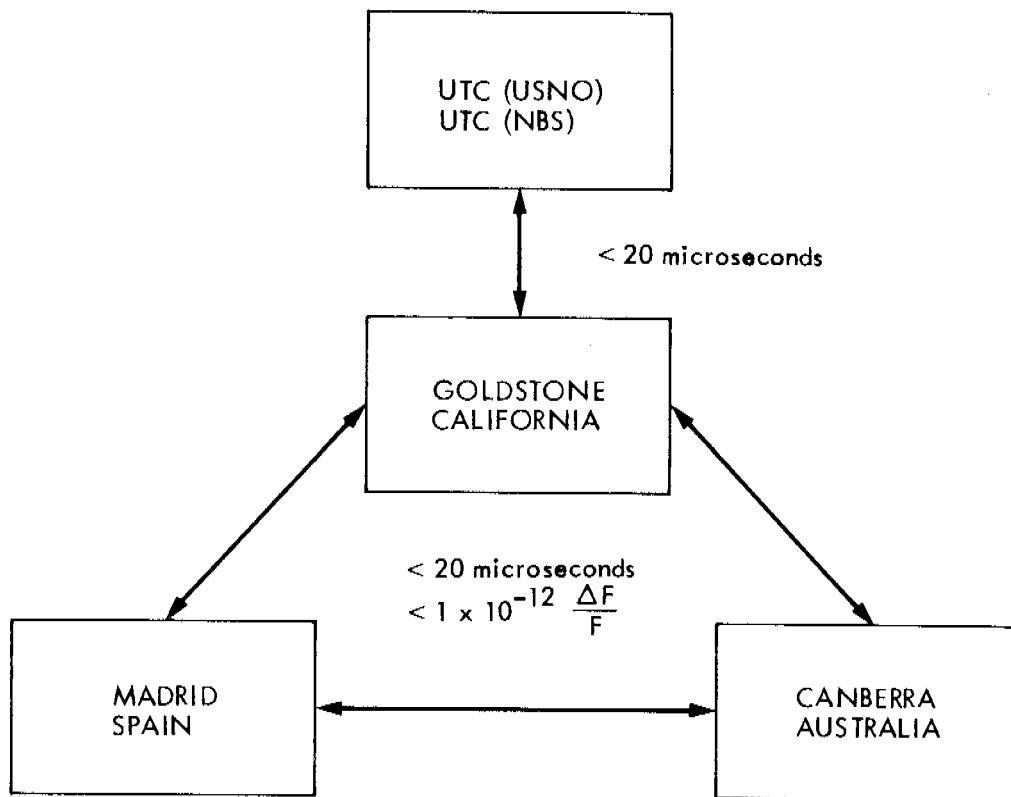

Figure 1. DFT System Functional Block Diagram

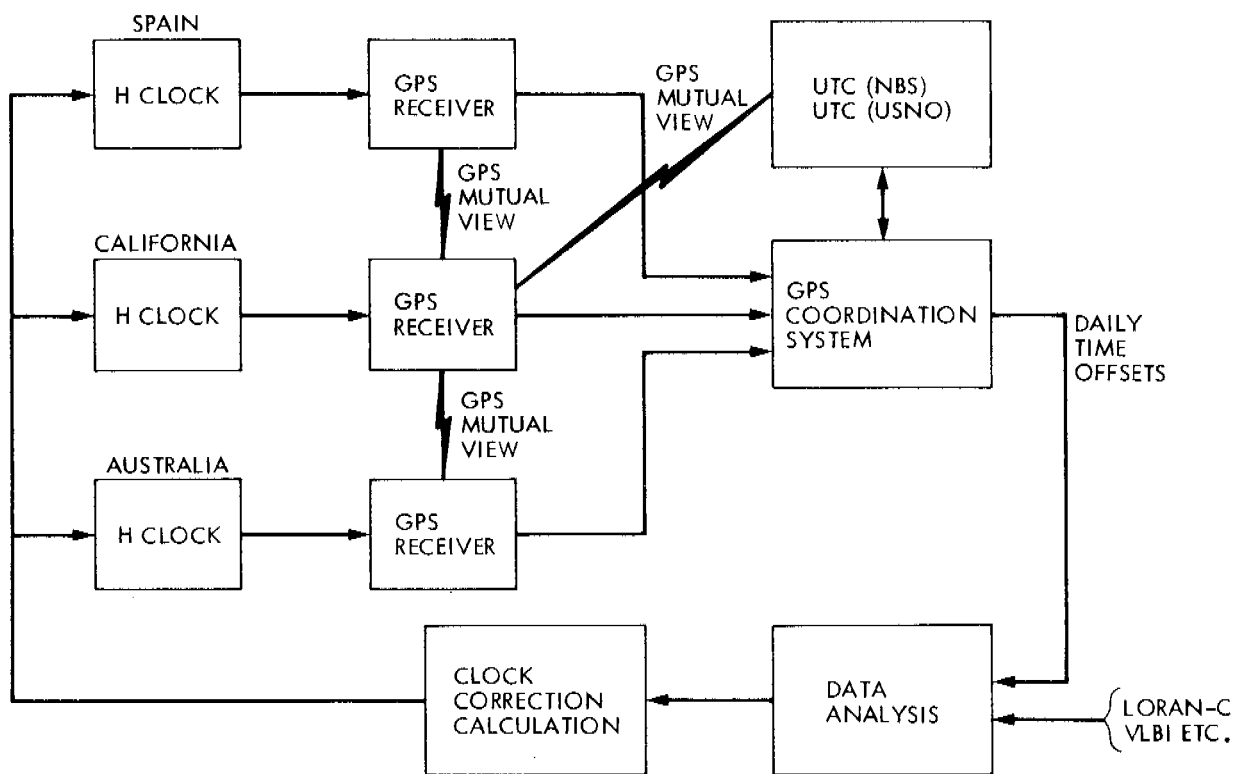

Figure 2. Frequency and Timing Control System

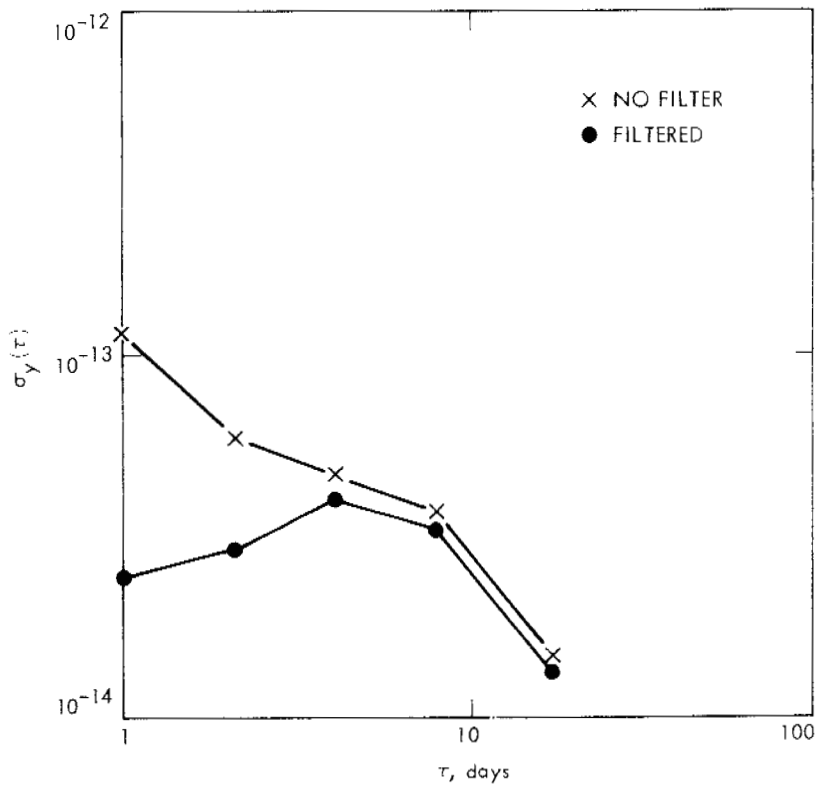

Figure 3. Allan Variances of Goldstone-UTC (NBS) Before and After Kalman Filter

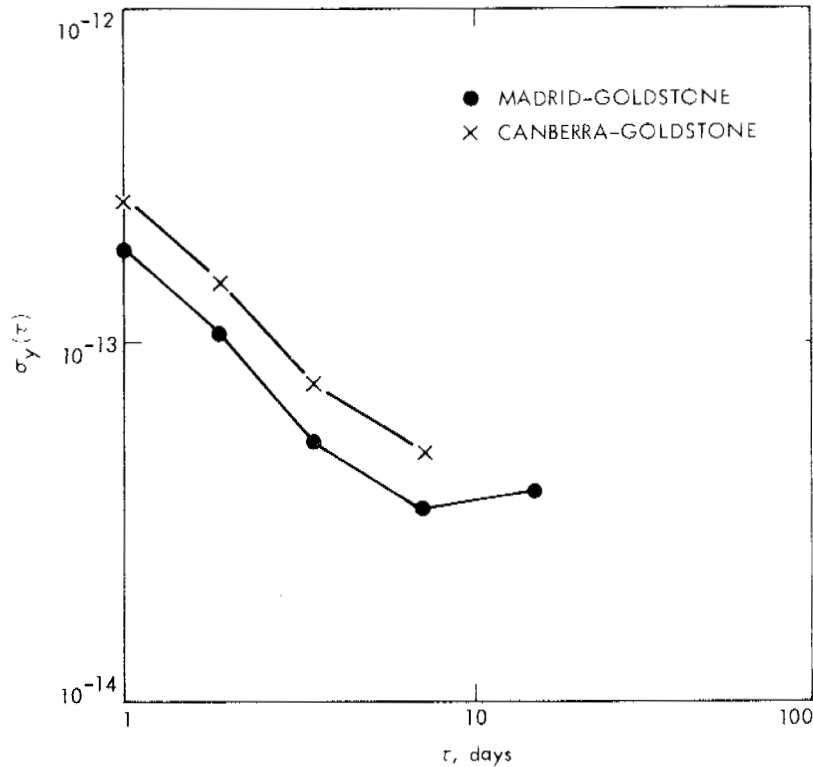

Figure 4. Allan Variances of Spain-California and Australia-California

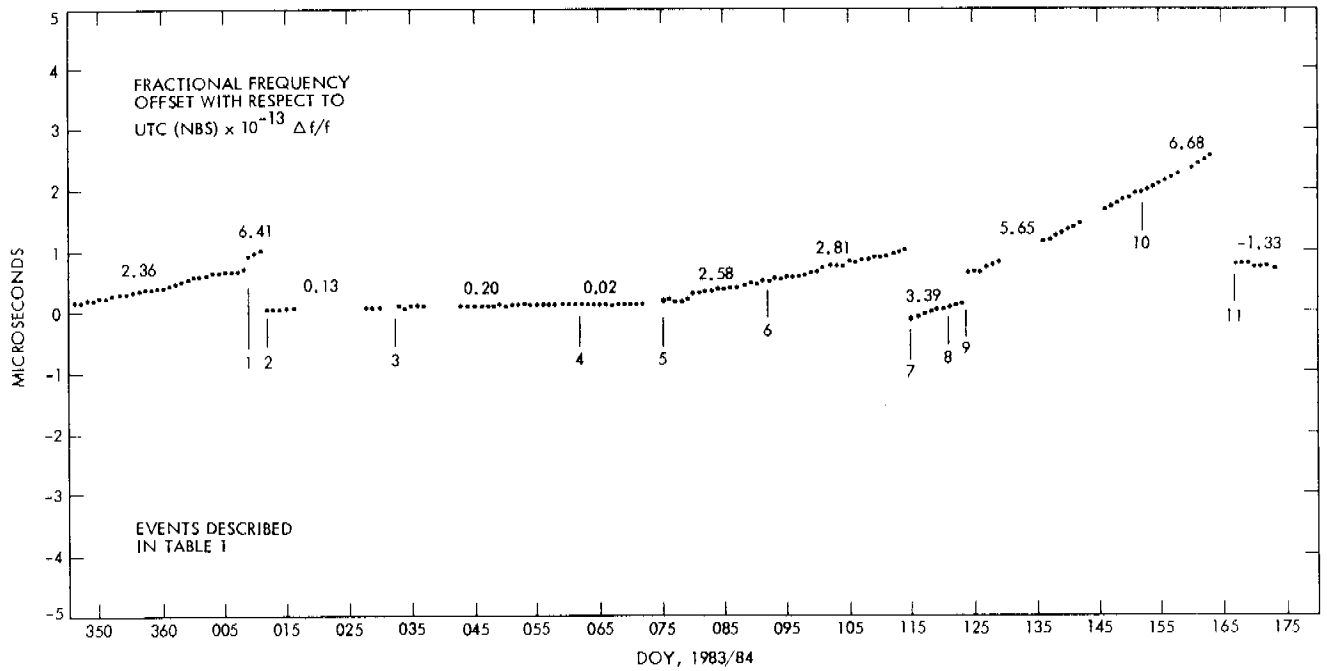

Figure 5. Time Offset, Goldstone versus UTC (NBS)

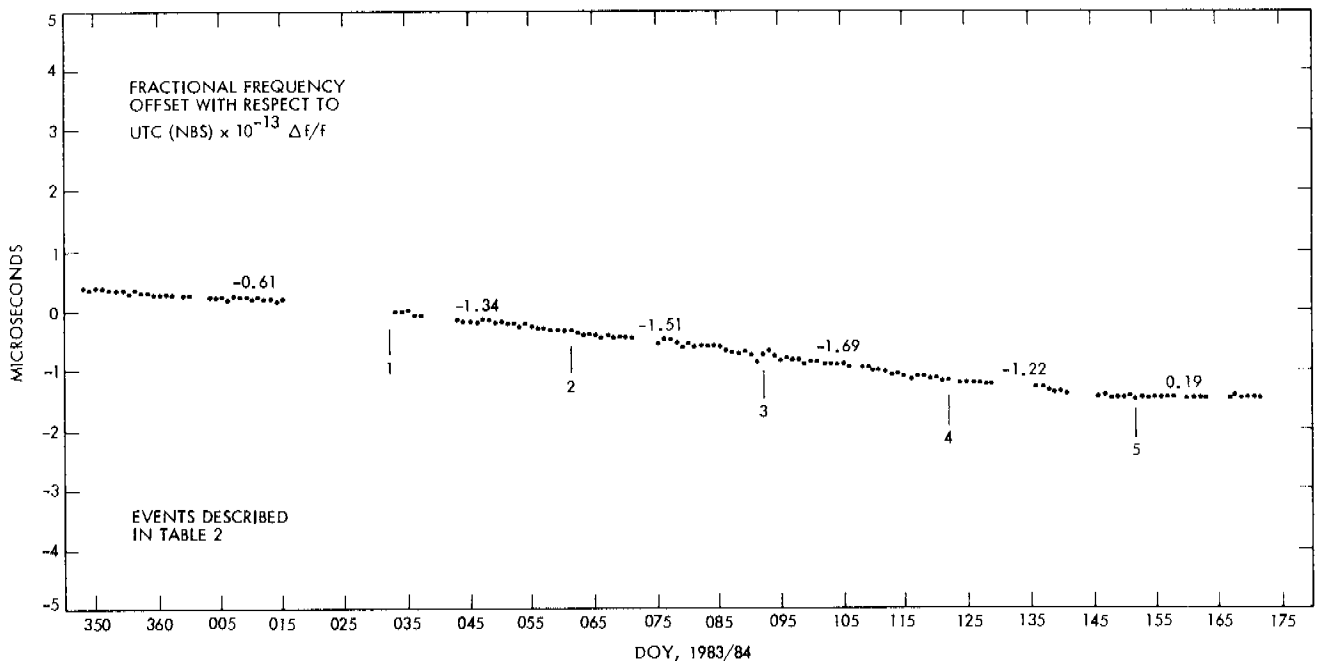

Figure 6. Time Offset, Canberra versus UTC (NBS)

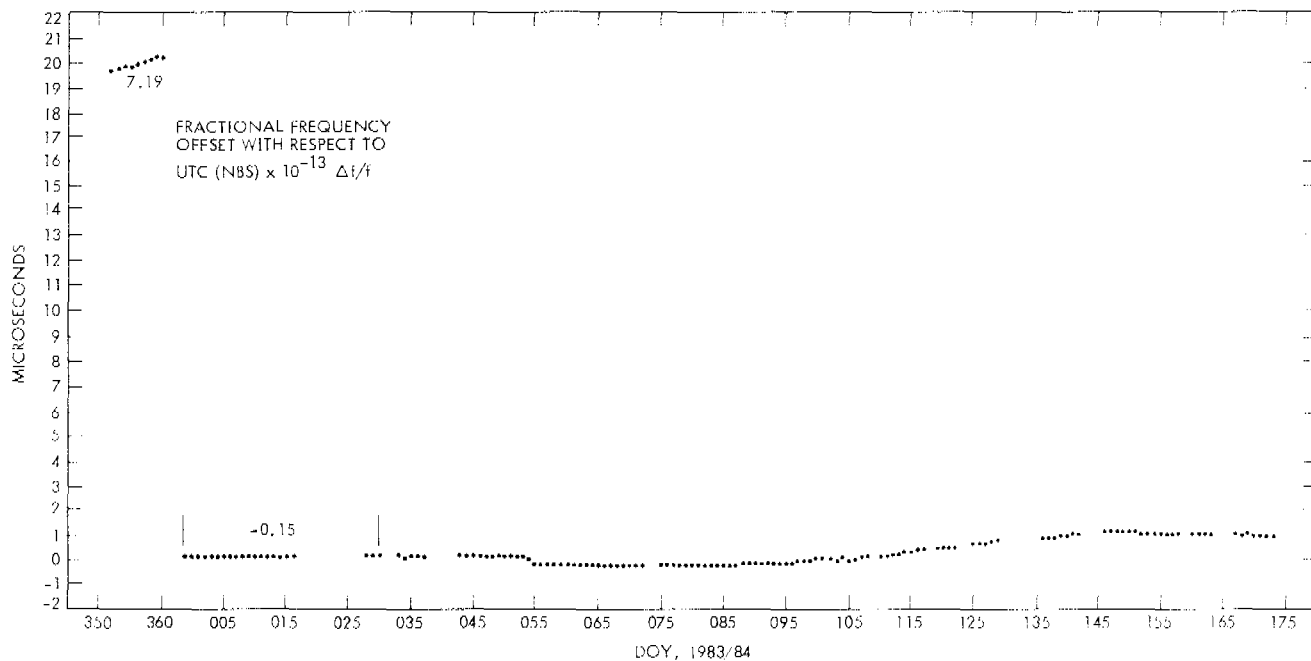

Figure 7a. Time Offset, Madrid versus UTC (NBS) Showing Frequency Adjustment and Clock Reset (Note the Different Ordinate Scale)

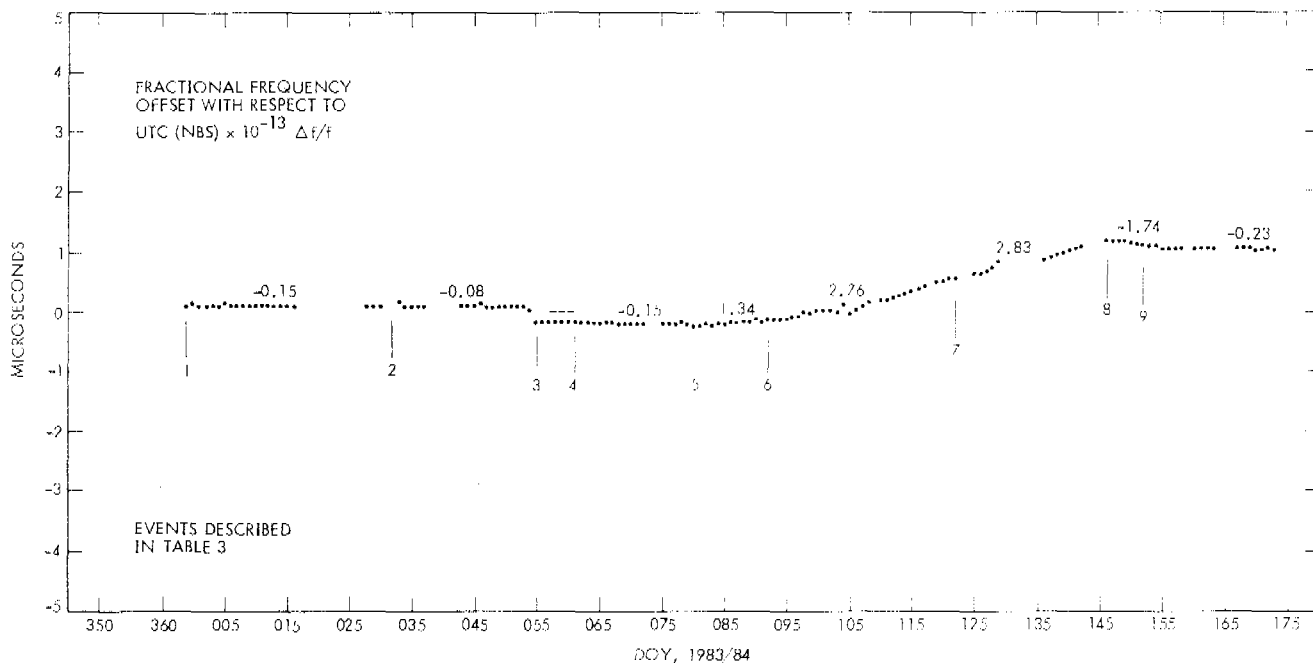

Figure 7b. Time Offset, Madrid versus UTC (NBS)

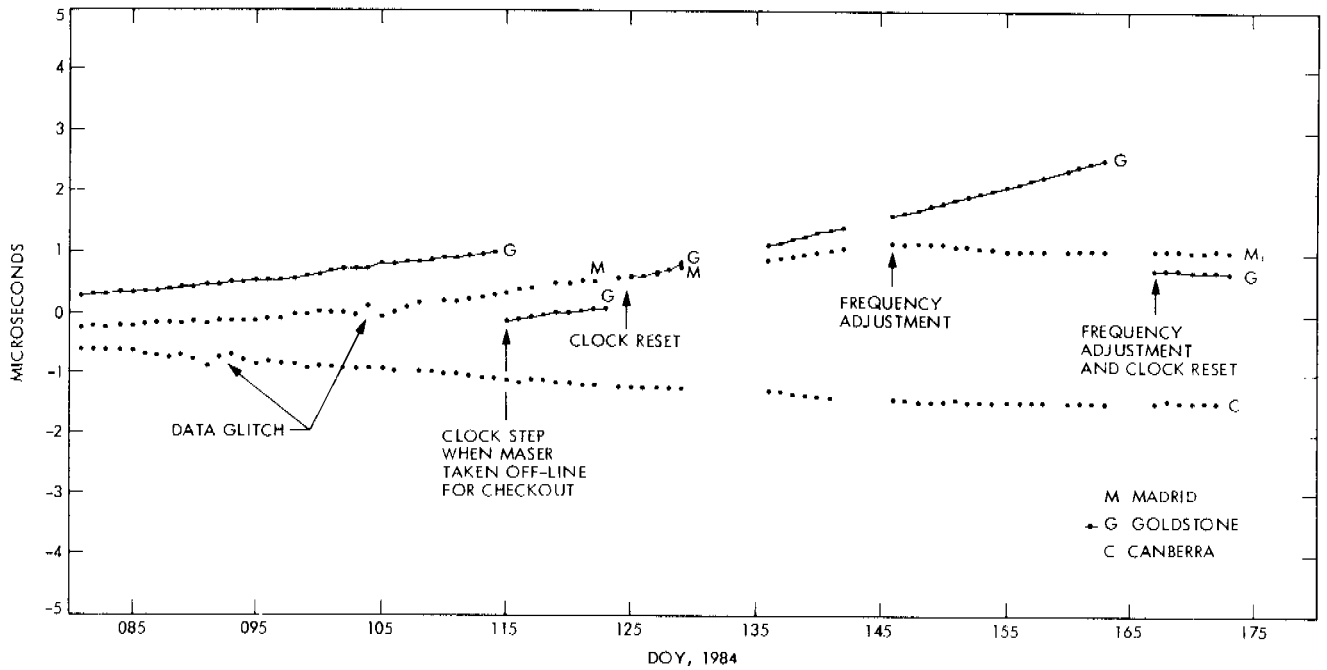

Figure 8. Time Offset, DFT System versus UTC (NBS), Showing All Three Stations

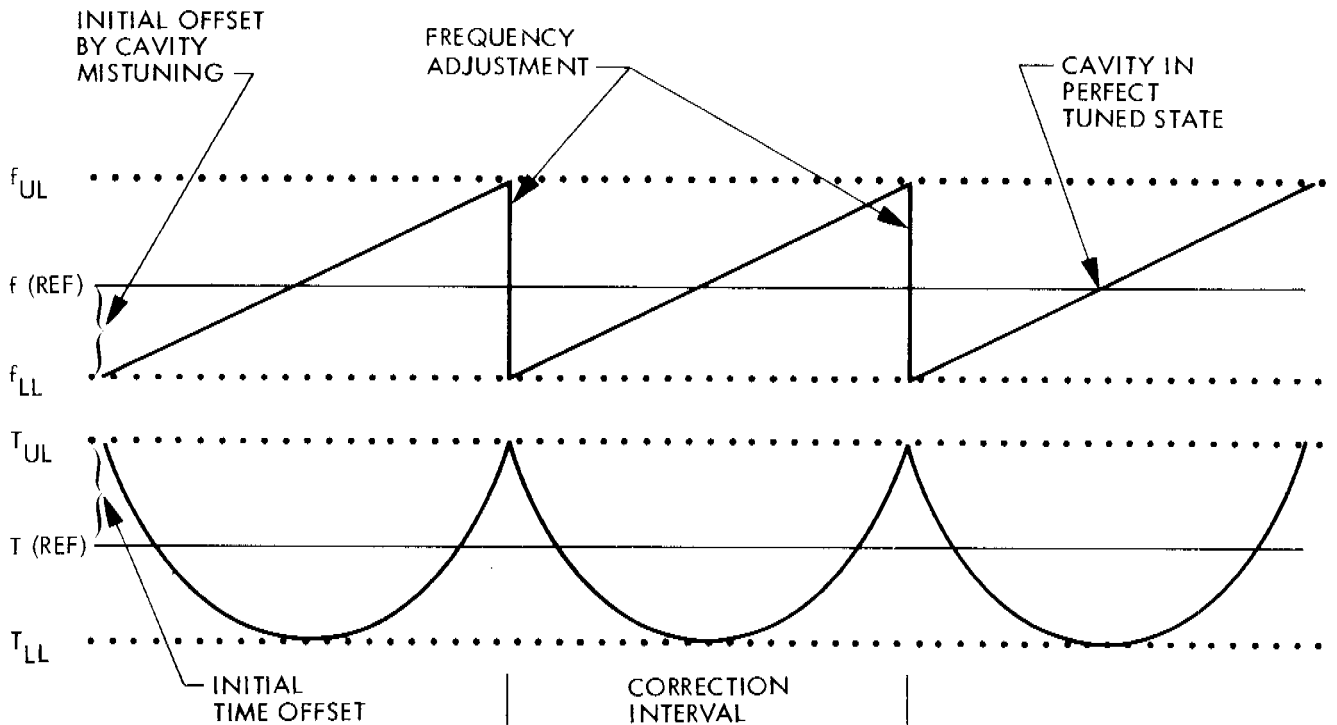

Figure 9. Frequency Correction Intervals Based on Known Cavity Drift and Allowable Limits

QUESTIONS AND ANSWERS

DAVID ALLAN, NATIONAL BUREAU OF STANDARDS: What was the temperature change, Phil, when you saw that frequency change on the Goldstone maser?

MR. CLEMENTS: Two degrees Celsius.

ANDY JOHNSON, U. S. NAVAL OBSERVATORY: Could you please tell the audience what kind of environment your masers are in?

MR. CLEMENTS: The masers are in a very well temperature controlled environment. There is a separate air conditioner that keeps the temperature to 22 degrees Celsius, plus or minus 0.1 Celsius.

MR. BUISSON: You presented mostly frequency. On the time aspect of it, do you have any feel, when you weren't adjusting frequency, how good your time comparisons would be between, say, Australia and Goldstone?

MR. CLEMENTS: That's hard. We made a clock trip last year, and reported it here. We had very good agreement, to within 25 to 50 nanoseconds.

What we are trying to do now -- Sam Ward will talk about it next -- is to use the weekly VLBI between the stations to check the accuracy of our time transfers.

ALBERT KIRK, JET PROPULSION LABORATORY: I didn't understand the last question. Could you explain?

MR. BUISSON: He showed a lot of plots of slopes of phase, and I was looking for absolute accuracy from a phase/time comparison.

MR. WARD: The filter data shows a rise in noise at a period of five days. What caused that?

MR. CLEMENTS: I don't know.

MR. BUISSON: That's an honest answer.

DAVID ALLAN, NATIONAL BUREAU OF STANDARDS: The Kalman smoother isn't a Kalman filter, it's really a smoother. We measure the characteristics of the propagation, the GPS noise if you will, and then we assume certain models for the clocks. These models are not perfectly well known. If you are not modeling the clock perfectly, you can get that kind of a hump in the sigma-tau plot, which may or may not be true to the clock. It's a model dependent characteristic. I wouldn't put too much stock in that humping.

I might mention that there have been several portable clock trips between the Goldstone clock and the Boulder clock, and they agreed -- and you can correct me if I am wrong -- by five nanoseconds.

MR. CLEMENTS: Yes, we make regular clock trips between the National Bureau of Standards and Goldstone, every two months supposedly, and we take the readings directly from the GPS receiver. We have come to within a few nanoseconds.

MR. BUISSON: That bothers me. Mr. Klobuchar talked yesterday. He talked about the difference in the ionosphere, and the holes, and having comparison that far with different times. Even though it's common view, you are looking at different parts of the sky, and it's hard to imagine that you are really down to the five nanosecond level if his drift rates are true, using a CA only code.

MR. CLEMENTS: We don't get down to the five nanosecond level with the overseas stations, only between NBS and Goldstone, which is less than a thousand kilometers.

MR. KLEPCZYNSKI: In regard to GPS time transfer, if you look at the data files that we have in the computer -- and I just did this a few days ago to compare Japan to the U.S.N.O -- if you take 780 second average points, for three or four days -- this is between Japan and the Observatory where you have a daytime situation on one end and a nighttime situation on the other -- you see a scatter of 40 to 50 nanoseconds between the points, which was right on the mark with the numbers that were quoted by Klobuchar yesterday.

MR. CAPLAN, NAVAL RESEARCH LABORATORY: Your graphs show that there were several apparent discontinuities in frequency. Did you correlate the data between the three stations in the network to try to isolate the cause of these changes in frequency?

MR. CLEMENTS: Yes, we compared the data and this clock was the only one with the change, so it was not in GPS.