

INTERNATIONAL TIME TRANSFER AND PORTABLE CLOCK EVALUATION
USING GPS TIMING RECEIVERS: PRELIMINARY RESULTS

S. C. Wardrip, NASA Goddard Space Flight Center

J. Buisson, O. J. Oaks, and M. Lister,
Naval Research Laboratory

E. Detoma, P. Dachel, T. Stalder, and H. Warren,
Bendix Field Engineering Corporation

G. Winkler and G. Luther, U.S. Naval Observatory

S. Leschiutta, Politecnico di Torino

P. G. Galliano, F. Cordara, and V. Pettiti,
Istituto Elettrotecnico Nazionale

R. Azzarone and F. Fedele, Italian Navy

INTRODUCTION

Four portable cesium clocks and two single channel Global Positioning System (GPS) timing receivers were deployed in Italy during October 1983 at the Naval Base in La Spezia, onboard the Italian Navy hydrographic ship "Magnaghi", and at the Istituto Elettrotecnico Nazionale (IEN) in Torino.

The experiment was a joint effort between the following U.S. and Italian agencies and organizations: the NASA Goddard Space Flight Center (GSFC) with the support of the Bendix Field Engineering Corporation (BFEC), the Italian Navy, the U.S. Naval Research Laboratory (NRL), the U.S. Naval Observatory (USNO), the Istituto Elettrotecnico Nazionale (IEN) "G. Ferraris", and the Politecnico of Torino, Italy.

The timing data collected in this effort provided mutual synchronization between the U.S. Naval Observatory and other international time-keeping institutions and laboratories to within an accuracy of ± 50 nanoseconds(ns).

In addition, the experiment provided an excellent opportunity to perform field tests of portable cesium standards during actual trip conditions. Onboard the hydrographic ship was an ensemble of three cesium clocks, which were intercompared via an automated measurement system. Two external time references, Loran-C and GPS, and one additional cesium standard were continuously available on shore, providing a redundant and reliable reference time base. Similar portable clock and GPS data was taken at the IEN, while performing a GPS synchronization for a period of one week.

PURPOSE OF THE EXPERIMENT

The overall experiment was designed to test the positioning and navigation capabilities of the GPS timing receivers developed by the Naval Research Laboratory (NRL) for the NASA Goddard Laser Tracking Network (GLTN).

To perform this experiment, a reliable and redundant time scale was set up onboard the ship, and a back-up system on shore. This situation provided the opportunity to perform simultaneously a timing experiment ideally divided into two parts, the main objectives of the experimentation being:

- 1.) To test GPS timing receiver synchronization capabilities on a moving platform, and to perform an intercontinental synchronization via GPS between participating international timing laboratories in Europe and in the United States.
2. To evaluate the performance of cesium portable clocks in the field.

SYNCHRONIZATION AND PORTABLE CLOCKS

The portable cesium clock synchronization technique represents one of the most accurate means to synchronize remote clocks via a transfer standard.

To perform a portable clock synchronization, the frequency offset of the cesium portable clock with reference to a known time scale should be measured with great accuracy; this will allow an estimate of the time position of the travelling clock during the trip, with reference to the same time scale, after an initial time position measurement has been made.

The behaviour of the portable clock during the trip is essential to obtain good results. When the clock returns, a time closure measurement with the master reference provides an estimate of how well the clock behaved during the trip. If an abnormal behaviour occurs, this can be classified into two categories: (1) a change in the frequency of the travelling standard (fig. 1a), or (2) a change in its time (phase jump) where the frequency before and after the trip appears to be the same (fig. 1b).

Abnormal behaviour of a portable cesium clock can be caused by several factors, but is mainly due to the random behaviour of the standard itself and by systematic effects.

RANDOM BEHAVIOUR OF THE CLOCK

The random behaviour of the clock is primarily due to the standard's own noise processes, leading to uncertainties in the determination of the frequency of the oscillator over a certain time interval, or to small fluctuations in the phase of the oscillator itself in a short time interval.

The error caused by the random behaviour of the clock can be reduced considerably by carefully monitoring the clock parameters before the trip, and by implementing various models of clock performance during the trip. It has been suggested to carry two or more cesium standards on a trip, and monitor one against the other.

However, the statistical analysis of the clock should only be considered at the level at which the systematic errors do not play a dominant role in contributing to the total trip error. In other words, it is not useful to have a good statistical model of the clock when the main error contribution is due to systematic effects.

SYSTEMATIC ERRORS

Inaccuracies in a portable clock during a trip can be traced to such systematic errors as temperature effects, acceleration and shock, power supply noise and/or voltage spikes, magnetic field sensitivity, and others.

Until a complete study of systematic errors is made, it is suggested (and in several cases it has already been done) to send a redundant set of 2 or more clocks, of different manufacturer and type, on portable clock trips, along with a portable data acquisition system, to allow a continuous intercomparison of the clocks for the trip duration.

In addition, clock reliability should be addressed by careful evaluation of clock performance, looking for the weak points of each design and suggesting ways to improve the confidence in the operation of the clock and clock subsystems (i.e., power supply modules).

MEASUREMENT SYSTEM CONFIGURATION

During the month of October 1983, personnel from the NASA, the NRL, and the BFEC performed a joint experiment with the Italian Navy and the IEN, with the aim to test the navigation capabilities of the GPS timing receivers onboard a hydrographic ship of the Italian Navy (fig. 2). This provided the opportunity to perform field tests of cesium standards during actual trip conditions.

Three portable cesium standards were available onboard the ship. One was provided by the IEN (HP5061 - CS1230), one by the USNO (HP5061, opt. 004 - CS1809) and the other by the NASA (FTS4010 - CS107). These three clocks provided redundant clock information during the experiment (fig. 3).

An automated measurement system was installed and operated onboard the ship for the duration of the experiment (fig. 6).

External time references were continuously available on shore, such as a LORAN-C timing receiver, TV links, an additional GPS timing receiver and one cesium standard, providing a reliable clock system that was mainly used as a backup to the main timing system onboard the ship.

INSTRUMENTATION ONBOARD THE SHIP

The measurement system is shown in fig. 4 and 5 and a block diagram is shown in fig. 6. An HP-85 computer acts as the system controller. The three cesium standards are intercompared via an HP59307 switch (shown in fig. 5 on top of the HP5370 counter), using an HP5370 counter in the time interval mode (20ps resolution).

The 1 pps signal from the USNO standard (CS1809) provides the master reference start signal to the counter. In this way, the 1 pps pulses and the 5 MHz signals of the cesium standards are intercompared.

A Time Systems Technology (TST model 6459) clock (fig. 4) was used as a precise 1 pps distribution amplifier. The same figure shows a 5 MHz distribution amplifier and the two GPS timing receivers onboard.

An HP Interface Bus (HPIB) compatible digital multimeter was used to monitor (via a standard thermistor) the ambient temperature, while an HPIB compatible clock (HP59309) provided time tags to the data.

The HP5370 and the other instruments were controlled by the HP-85 via the HPIB. The data was collected approximately every 30 minutes and stored on tape for further processing.

In addition, manual readings were taken between the 1 pps signals. Phase monitoring of two 5 MHz signals was provided by a Tracor phase comparator and recorder unit (fig. 3).

The 1 pps and 5 MHz signals generated by each clock were compared against the 1 pps signal of the reference cesium (CS1809). Each data consisted of the average and standard deviation of ten time interval readings between the 1 pps reference signal and the signal being measured (fig. 6). Both the average and the standard deviation of each measurement was stored on tape, along with the time of the measurement and the ambient temperature.

The system failed to operate several times, mainly because of electrical power interruptions (the system had no battery backup). Power interruptions occurred when switching from onboard to shore power and vice versa, and when power was redistributed to balance the load on various distribution lines. Power interruptions were the cause of one of the power failures on CS107, the other was an unplugged power cable.

As a consequence of the power failures, the computer stopped. The auto-start provision was not enabled since the time-tagging digital clock needed to be reset to the proper time, which required operator intervention.

Inproper setting of the digital clock (perhaps caused by noise or spikes on the power line) resulted in uncertain time tagging of the data on October 6 and 7. Even though this data cannot be referenced to pre or post data, it was used to monitor the frequency of the clocks during that period (see tables I, II, and III).

BACK-UP TIMING SYSTEM ON SHORE

The back-up timing system (fig. 7) was installed by the IEN on shore, in a building inside the Naval Base complex. A block diagram of this system is shown in fig. 8.

The local time base was obtained from a HP5061A (CS609) cesium standard. External references included a TV link to UTC (IEN), while LORAN-C and GPS measurements were provided by an Austron 2005 LORAN-C timing receiver and a second NRL GPS time transfer receiver, installed on shore from October 4 to October 8 and later installed onboard the ship for redundant operation.

The measurement system included a HP5345A time interval counter (2ns measurement resolution in the time interval mode), a HP59307 switch, and a HP9815 desk top calculator, which acted as the system controller and data logger. The measured data was stored on tape.

CESIUM CLOCKS PERFORMANCE

The reference cesium standard (CS1809 - HP5061A opt. 004) performed very well, with a 120 ns closure error versus UTC(USNO) after the 17 day trip.

One of the two cesium standards onboard (CS1230 - HP5061A) experienced a phase shift that will be discussed later. The other (CS107 - FTS4010) had two power failures onboard, the first time due to an unplugged connector, and the second time during a switch between shore to onboard power while changing the battery pack.

The frequency of each clock (CS1230 and CS107) versus the reference clock (CS1809) was estimated from the 1 pps comparisons over the measurement intervals listed in table I. The fractional frequency offset was computed as the slope of the fit (line) to the phase data. The standard deviation of the fit and the standard deviation of the slope (frequency) were computed and are given in table II (CS107) and table III (CS1230). The uncertainty in the fractional frequency offset estimate was weighted for the number of data points used in the fitting process by using the Student t-distribution to correct the standard deviation of the slope.

The results of the analysis for CS107 are summarized in fig. 9. The vertical axis is the fractional frequency offset between CS1809 and CS107, the horizontal axis is time (days, October 1983). Each frequency estimate is plotted as a horizontal bar extended over the measurement period. The height of the box around the bar represents the uncertainty of the frequency offset determination over the same period (see legend, fig. 9). The asterisks mark the time of the power failures. Since the vertical scale is 10ns/day per division, this is roughly equivalent to 1×10^{-13} per vertical division.

During the first week the behaviour of CS107 was excellent, then there was the first power failure on the morning of October 8 and the second one on the morning of the 10th. After a warm-up period of approximately two days, the frequency returned to about the original value. The lower frequency on day 11 is unexplained. Notice, however, the large uncertainty.

This change does not appear so dramatic in a phase plot over the same period (fig. 10). Fig. 10 shows the phase behavior of CS107 versus CS1809 on October 10 and 11, 1983, when CS107 was just recovering after the two power failures. The change in slope on October 11 is evident. In the plot to the right (fig. 10) the line fitted over the measurement period is superimposed on the data. The average slope tends to be slightly higher than the slopes estimated on partial intervals covering the same period of time. This is caused by non-linear behaviour of the data.

The average fractional frequency offset between the two clocks after the power failure was then 198 ± 2.6 ns/day (on days 10 and 11); during the first week (on days 5 and 6, fig. 11) the average slope was 208.7 ± 2.3 ns/day. The difference was only 10.7 ns/day (± 5.6 ns/day in the worst case), roughly 1×10^{-13} in frequency difference before and after the power failure.

CS1230 was noisier than CS107 and showed a more random phase behaviour (fig. 12). There is a definite change in the frequency of CS1230 from October 4 to October 5 and 6 (fig. 12). The random walk of CS1230 is evident in fig. 13 (October 10 to 12); however, the long term performance was satisfactory.

On the morning of October 7 there was a phase shift in CS1230 (see fig. 14, top plot). The magnitude of the phase jump was roughly 100ns in less than 4 hours. The bottom plot in fig. 14 shows the simultaneous temperature recording. There was a large temperature inversion, due to the turn-on of the ship's air conditioning equipment, at the time when the phase shift started. The absolute temperature was not very high (about 76° F). The slope on October 6 and 7 was about 121 +/- 2.1 ns/day. After the shift, the average slope was about 129 +/- 3.4ns/day. The shift in phase does not appear to have affected the frequency of the cesium.

Table IV presents a summary of the comparison of the two cesiums (CS107 and CS1230) versus the reference CS1809. The average fractional frequency offset is the arithmetic mean of the frequency offsets shown in tables II and III, with two data points removed on days 8 and 10, where an external power failure interrupted the operation of CS107. One data point was removed on day 7 for the large phase jump in CS1230 which affected the normal behavior of the clock. The standard deviation shown is the standard deviation on the above computed average.

TEMPERATURE ANALYSIS

The purpose of the temperature measurements was to monitor frequency changes due to temperature variations in the field. These can be monitored against a remote reference time scale or against a local standard, but are unaffected by the same temperature changes (absolute frequency dependence on temperature). Alternatively, given an ensemble of clocks exposed to the same temperature variations, frequency changes in one standard versus the others can be monitored (relative frequency dependence on temperature).

The main limitation that was found in carrying on such measurements was that, in both cases, the frequency changes due to short term temperature variations are the same order of magnitude or less than the uncertainty in the short term evaluation of the frequency of the cesium standard. In this experiment, it was not possible to find any substantial correlation between frequency changes and short term temperature variations in the field. Moreover, external references and existing time transfer links do not provide enough accuracy to monitor short term frequency changes.

SYNCHRONIZATION LINKS AVAILABLE DURING THE GPS EXPERIMENT.

Figure 15 shows the various synchronization links that were available during the experiment.

Two time scales were used as a reference: UTC (USNO) and UTC(IEN). Both are reporting to the Bureau International de l'Heure (BIH) and their relative positions can be obtained from the BIH report. As a direct link, two systems were available, in

addition to two GPS timing receivers: (1) Transit Time Transfer receivers (FTS T-200), located at the IEN and at the USNO, provided 10 to 25 microseconds accuracy in time transfer, and (2) LORAN-C, provided indirect synchronization across the Atlantic Ocean of 1 to 10 microseconds.

In contrast, the GPS timing receivers provided time comparison of remote clocks with an accuracy of 50 to 100ns between the USNO, the ship, the La Spezia harbour and the IEN.

To have an independent synchronization link between La Spezia and the IEN in Torino, one LORAN-C timing receiver was installed by the IEN on shore. This provided synchronization to better than 100ns, and an additional, independent reference to UTC (USNO), even if with less certainty.

Moreover, to provide a more precise synchronization between the IEN and La Spezia, the IEN personnel set-up a TV measurement system, taking daily readings at 0900Z at IEN and La Spezia, with an estimated accuracy between 10 and 50ns.

In this way, it was possible to insure accuracy, reliability and redundancy to the clocks in the field, while referencing them continuously to existing time scales.

As shown in table V, there is a wide spread of accuracies available from existing systems, but no one system provides better than 10 to 50ns for comparison of remote clocks. Local (direct) time interval readings between cesium clocks usually have an uncertainty of 1 to 10ns within a 1 day period, equivalent to the typical noise floor of a good cesium standard.

TEMPERATURE BEHAVIOUR

Fig. 16 shows typical plots of temperature versus time during the experiment. The temperature onboard was not controlled, except for a manually operated air conditioning system; the thermistor probe was suspended above the ensemble of the three clocks.

The chart shown in fig. 17 presents the temperature variations onboard the ship. The horizontal bar extended over the measurement period is the average temperature over the same period. The height of the box around the bar represents the standard deviation of the average. Dot and cross symbols indicate the minimum and maximum temperature recorded within each measurement period.

As shown in table VI, (which presents a summary of the temperature measurements), despite large short term temperature variations, the average temperature during the experiment was fairly constant (around 70° Fahrenheit). The largest standard deviation is 5.8° Fahrenheit, however the average standard deviation is only 2.6° Fahrenheit.

Short term temperature variations do not seem to affect the behaviour of portable cesium clocks, at least to increase substantially the phase error at a measurable level.

A redundant set of portable clocks traveling together will certainly improve the reliability, but not necessarily the accuracy of the synchronization.

TIME TRANSFER USING GPS RECEIVERS ONBOARD A MOVING PLATFORM

The primary objective of the synchronization experiment was to evaluate the time transfer capability of a single channel C/A Code GPS timing receiver while onboard a moving platform.

THE NAVSTAR GLOBAL POSITIONING SYSTEM

NAVSTAR GPS is a tri-service Department of Defense (DOD) program. The first GPS satellite flown was The Navigation Technology Satellite (NTS-II) which was designed and built by NRL personnel. GPS will provide the capability of very precise instantaneous navigation and transfer of time from any point on the Earth. GPS comprises three segments: the Space Segment, the Control Segment and the User Segment. The phase III Space Segment will consist of a constellation of 18 to 24 satellites, six to eight in each of three orbital planes. The satellite orbits are nearly circular at an altitude of about 20,000 km and inclined 55° to the equator. The period is one half of a sidereal day, resulting in a constant ground track, but with the satellite appearing 4 minutes earlier each day.

Each satellite transmits its own identification and orbital information continuously. The transmissions are spread spectrum signals, formed by adding the data to a direct sequence code, which is then biphase modulated onto a carrier. At the present time, the control segment consists of a Master Control Station (MCS) and four monitor stations.

The monitor stations collect data from each satellite and transmit to the MCS. The data are processed to determine the orbital characteristics of each satellite, and the trajectory information is then uploaded to each satellite once every 24 hours as the spacecraft passes over the MCS. The user segment consists of a variety of platforms containing GPS receivers, which track the satellite signals and process the data to determine position and/or time by simultaneous or sequential reception of at least four satellites.

GPS TIME TRANSFER RECEIVER (TTR)

As an outgrowth of the NTS timing receiver development in 1977 by the NRL and the GSFC, a joint effort was started in 1979 to develop GPS TTR's using signals radiated by the GPS satellites. In support of the GSFC Crustal Dynamics Program, the GPS TTR's were designed for use in the GSFC Transportable Laser Ranging Network, which requires submicrosecond timing for correlation of highly accurate satellite tracking data with time.

The capabilities of the receiver are being expanded, mainly through software modifications, for the following reasons:

- o Demonstrate the position location capabilities of a single channel receiver using the GPS C/A code.
- o Demonstrate the time/navigation capability of the receiver onboard a moving platform, by sequential tracking of GPS satellites.
- o Develop a timing receiver capable of worldwide synchronization from a moving platform.

The GPS TTR is a microcomputer based system which operates at the single L-band frequency of 1575 MHz. The receiver uses the C/A code only (1.023 MHz), tracking this code to within 3% of a chip (30ns). The receiver has the capability to track satellites throughout their doppler range from horizon to horizon, and can track any GPS satellite by changing the receiver internal code. Operator interface with the receiver is provided by a keyboard and CRT display. The time data is stored on disks and can also be output to an external printer/computer via a serial data interface (fig. 19).

TIME TRANSFER METHOD

The GPS TTR's (fig. 4) installed onboard the ship were driven directly by the reference cesium standard CS1809. The time transfer was obtained as part of a five dimensional navigation solution (see ref. 1), solving for latitude, longitude, heading, speed of the ship, and time. Time here refers to the difference between the GPS system time and the local clock.

The time solution was usually obtained over a 30 minute integration time; the measurements were gathered from 3 to 5 NAVSTAR satellites. The time transfer results were compared with the estimated position of CS1809 (used as the local time reference in the synchronization).

The plot shown in fig. 20 presents the results of the time transfer onboard the moving ship. The square symbols represent the time difference between UTC(USNO) and CS1809 via the GPS solution. The crosses represent the same difference, but estimate the position of the portable clock CS1809 with reference to the USNO. The error bars represent the uncertainty in the estimated clock position in time.

Except for two large discrepancies (around 200ns) on October 5 (day 278) and on October 10 (day 283), the average accuracy was around 100ns.

RESULTS OF THE SYNCHRONIZATION AT THE ISTITUTO ELETTROTECNICO NAZIONALE (IEN).

From October 13 to October 19, identical GPS receivers were installed at the IEN facilities (fig. 22) in Torino, to perform a final synchronization via the GPS.

The two GPS receivers (see the block diagram in fig. 21) were driven by the IEN master clock (An HP5061A, opt. 004, cesium standard), that is part of an ensemble of commercial cesium clocks kept in an underground vault (fig. 22).

The four clocks participating in the navigation experiment (CS1809, CS107, CS1230 and CS609, the last being the one installed on shore at La Spezia) were continuously monitored against each other and against UTC(IEN) for one week.

In addition, measurements via GPS were carried on by temporarily driving the receivers with the portable clocks CS107 and CS1809, to check the time position of the traveling clocks with reference to UTC(USNO).

TIME TRANSFER METHOD VIA GPS FOR A STATIONARY RECEIVER

The major objective of a satellite time transfer receiver is to determine precise time differences between a given satellite and a local ground clock. Precise time

can then be obtained between the space vehicle (SV) and a single remote ground station clock or between the SV and any number of remote stations. The remote sites could then be synchronized among themselves (fig. 18).

To perform a satellite time transfer with GPS, pseudo-range measurements are made that consist of the propagation delay in the signal plus the difference between the satellite clock and the ground station receiver reference clock. Data from the navigation message contain the satellite clock information and the satellite ephemeris, which allows one to compute the satellite position. Since the position of the satellite and of the ground station are known, the computed propagation delay can be subtracted from the pseudo-range and then corrected for the GPS time offset, to determine the final result of ground station time relative to GPS time, which can be referenced to the USNO.

If two ground station clocks are synchronized to GPS time, the results can be subtracted to obtain the time difference between the ground station clocks. This can be done at any time, but best results are obtained when data is taken simultaneously by each ground station from the same satellite (common view), since any error contributed by the satellite clock is cancelled when the data is subtracted.

The GPS time offset, that is the difference between GPS time and UTC(USNO), can be obtained directly in real time as a part of the information broadcast by each satellite.

However, the synchronization results can be improved (as will be shown later), if the difference between UTC(USNO) and GPS time is measured simultaneously or nearly simultaneously (within a few hours) by a GPS time transfer receiver operated at the USNO. This data is made available by the Naval Observatory.

The Phase I GPS time is maintained at the Vandenberg MCS using a cesium oscillator. The Phase III GPS time is planned to be referenced from the MCS to the USNO Master Clock. The final results obtained from a single-frequency receiver, will contain a small error due to the ionospheric delay which may be modeled and corrected.

Fig. 24 shows the time difference between UTC(USNO) and CS107 measured at the IEN. CS107 was directly driving one of the GPS receivers; the asterisks show the estimated position of CS107 with reference to UTC(USNO). NAVSTAR 5 was the satellite used in the time transfer.

The difference between GPS time and UTC(USNO) was obtained in real time from the navigation message transmitted by the satellite.

When the same difference between GPS time and UTC(USNO) was obtained via direct measurements carried on almost simultaneously at the Naval Observatory, the results show a better agreement between the predicted clock position and the GPS time transfer, as shown in fig. 25.

Fig. 26 shows the time difference between UTC(USNO) and CS1809, the latter driving one of the GPS timing receivers at the IEN. Again, the difference between GPS time and UTC (USNO) was obtained from the navigation message. An offset is clearly visible between the estimated clock position (asterisks) and the GPS time transfer

indicated by the number 5, indicating NAVSTAR 5. However, if the measurements carried on at the Naval Observatory are used in place of the prediction broadcasted in real time by the satellite, again the offset disappears (fig. 27).

Fig. 28 presents a summary of the time transfer between the USNO and the IEN. The asterisks show the difference between UTC(USNO) and UTC(IEN) via the portable clock references. The numbers plotted identify the time transfer obtained via a particular NAVSTAR satellite (number 3, 4, 5, 6 and 8). Again, the difference between UTC(USNO) and GPS time was obtained in real time from the navigation message. When the direct measurements at the Naval Observatory are used to evaluate the difference between the USNO and GPS time, the time transfer via GPS shows a better agreement with the portable clock data (fig. 29). The accuracy of estimated time position of the portable clocks was within 50 to 100ns for the days shown.

This experiment proved that the time transfer using NRL GPS timing receivers can achieve a worldwide, reliable accuracy within 50 to 100ns, which is well within the requirements for the synchronization of the NASA Laser Tracking Network.

ACKNOWLEDGMENTS

This work would not have been possible without the efforts and the cooperation of many people. In particular we would like to express our sincere thanks to the Captain and the crew of the ship "Magnaghi", to the Mini-Ranger and Raydist ground stations support teams and to the engineers and technicians of the BFEC, the NRL, the Italian Navy and the IEN.

This work was jointly funded by the National Aeronautics and Space Administration, the Italian National Council of Research (National Space Plan) and by the Italian Navy.

REFERENCES

- 1) - J. Buisson et al., GPS NAVIGATION EXPERIMENT USING HIGH PRECISION GPS TIMING RECEIVERS, Proceedings of the 15th Precise Time and Time Interval Meeting.
- 2) - C. Wardrip et al., AN INTERNATIONAL TIME TRANSFER EXPERIMENT VIA THE GLOBAL POSITIONING SYSTEM (GPS), Proceedings of the 37th Annual Symposium on Frequency Control (Philadelphia, 1-3 June 1983), pp. 61-66.

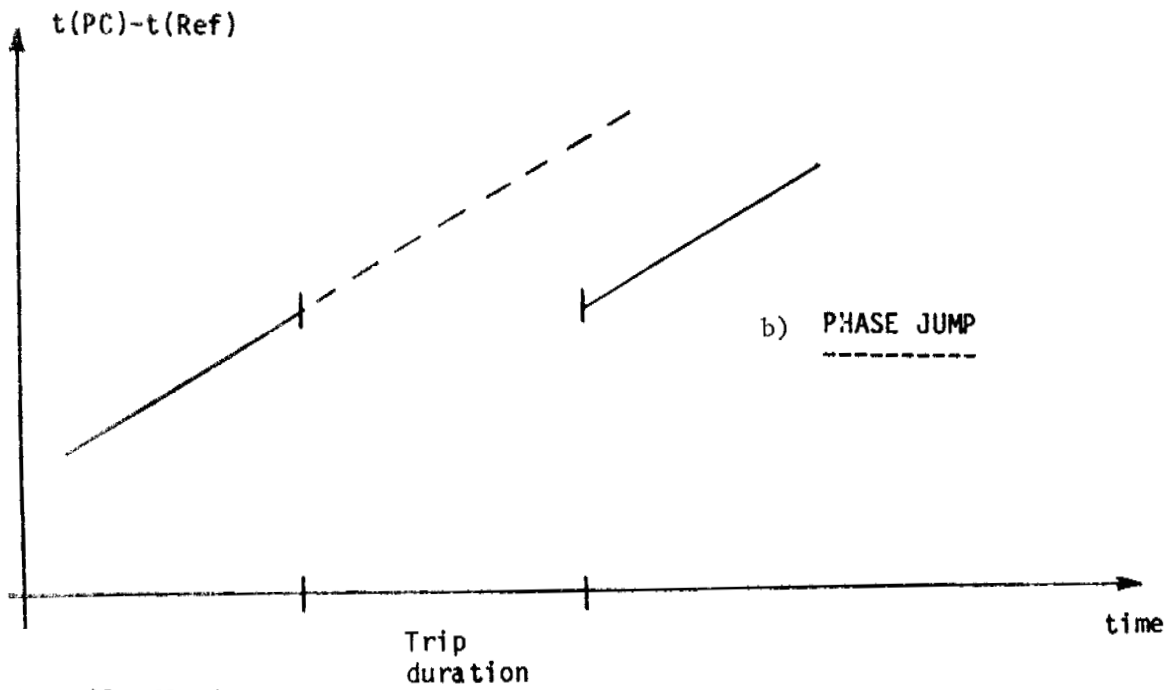
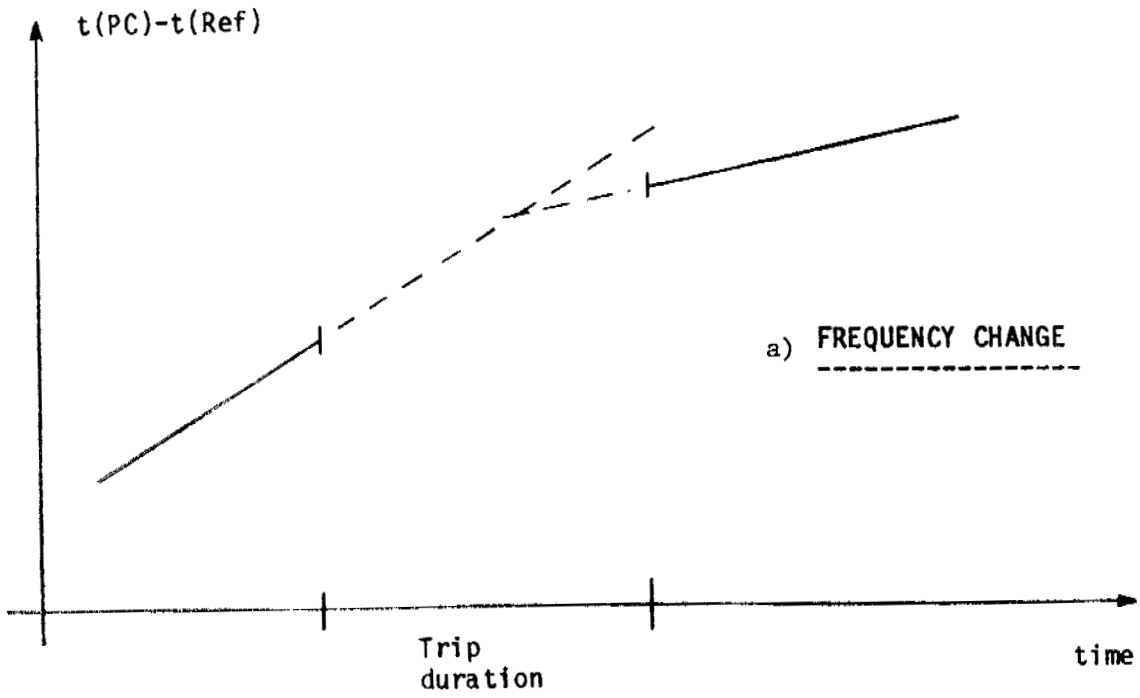

PC = Portable Clock
 Ref = Reference time scale

Fig. 1 - UNCERTAINTIES AFFECTING PORTABLE CLOCKS PERFORMANCE

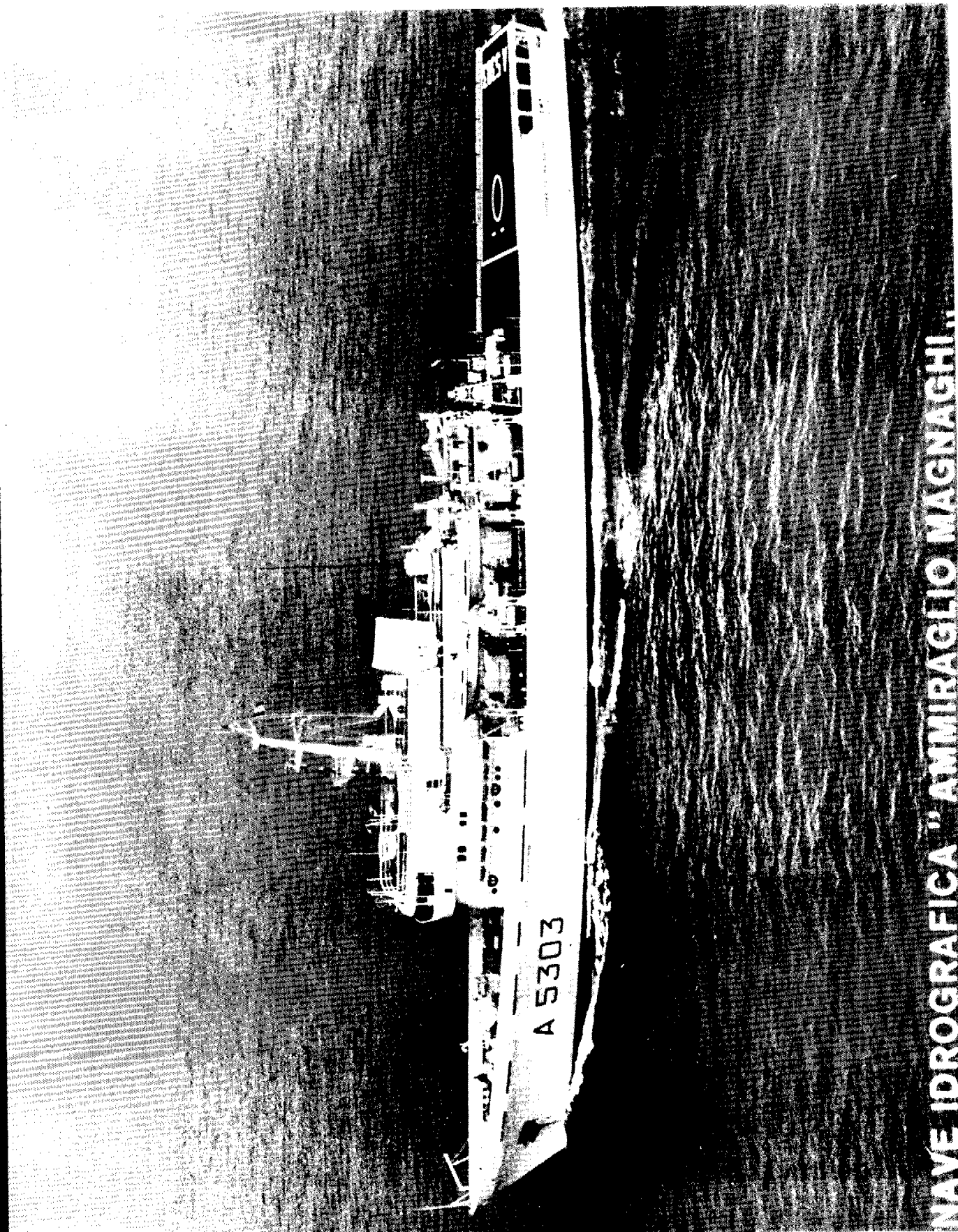

NAVE IDROGRAFICA "AMMIRAGLIO MAGNAGHI"

Fig. 2

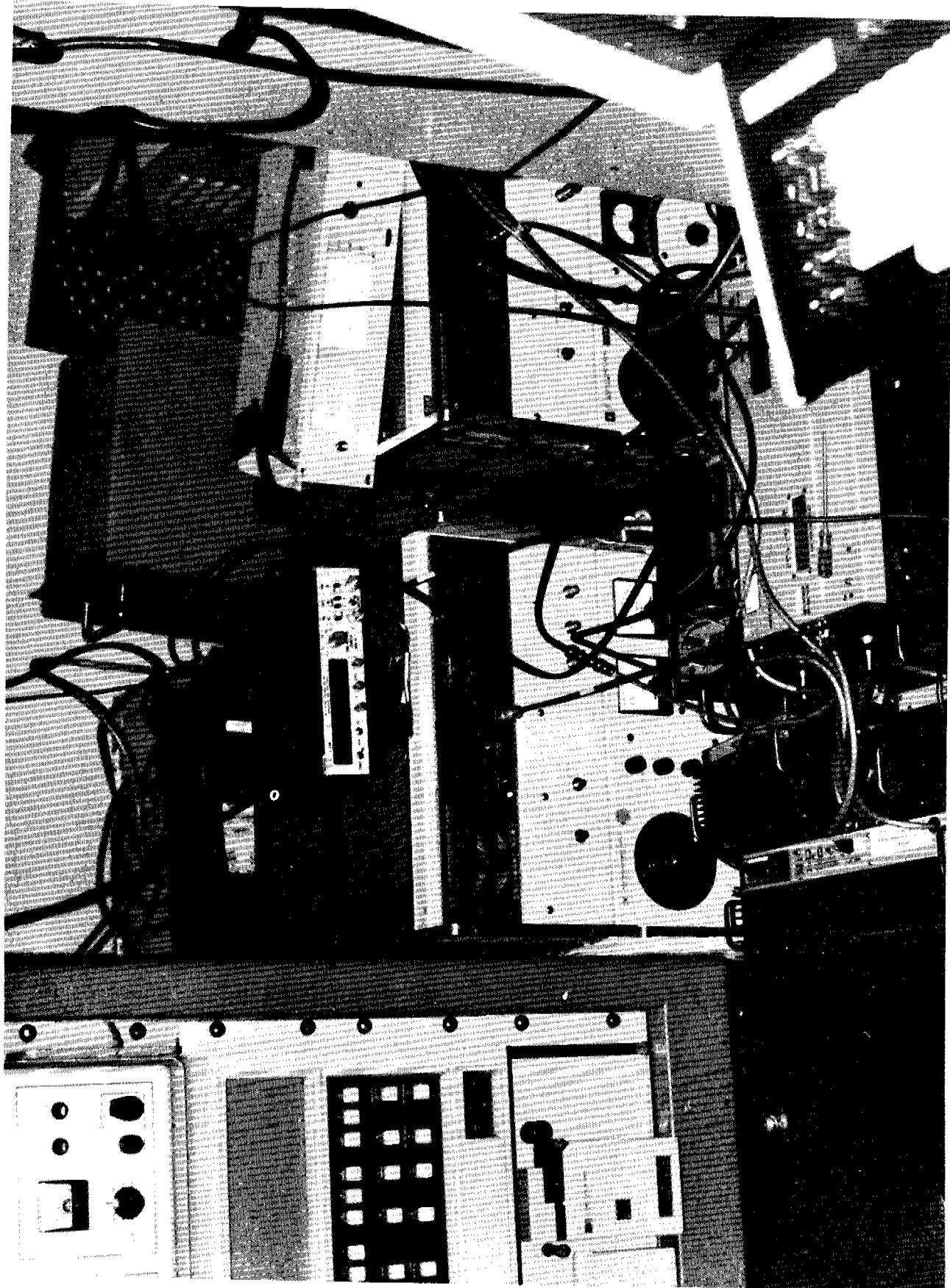

Fig. 3 - Cesium standards onboard the ship

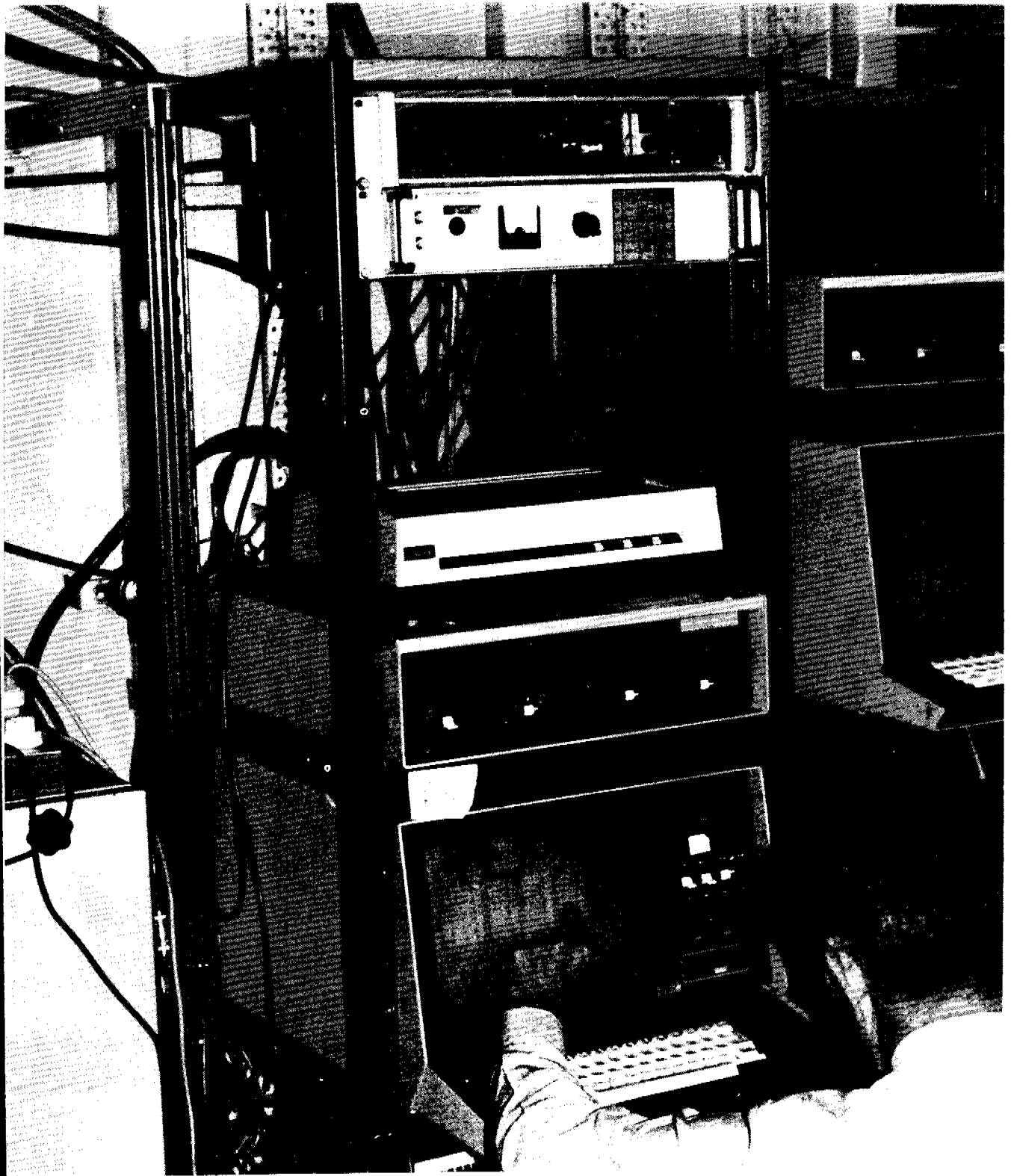

Fig. 4 - GPS time transfer receivers onboard

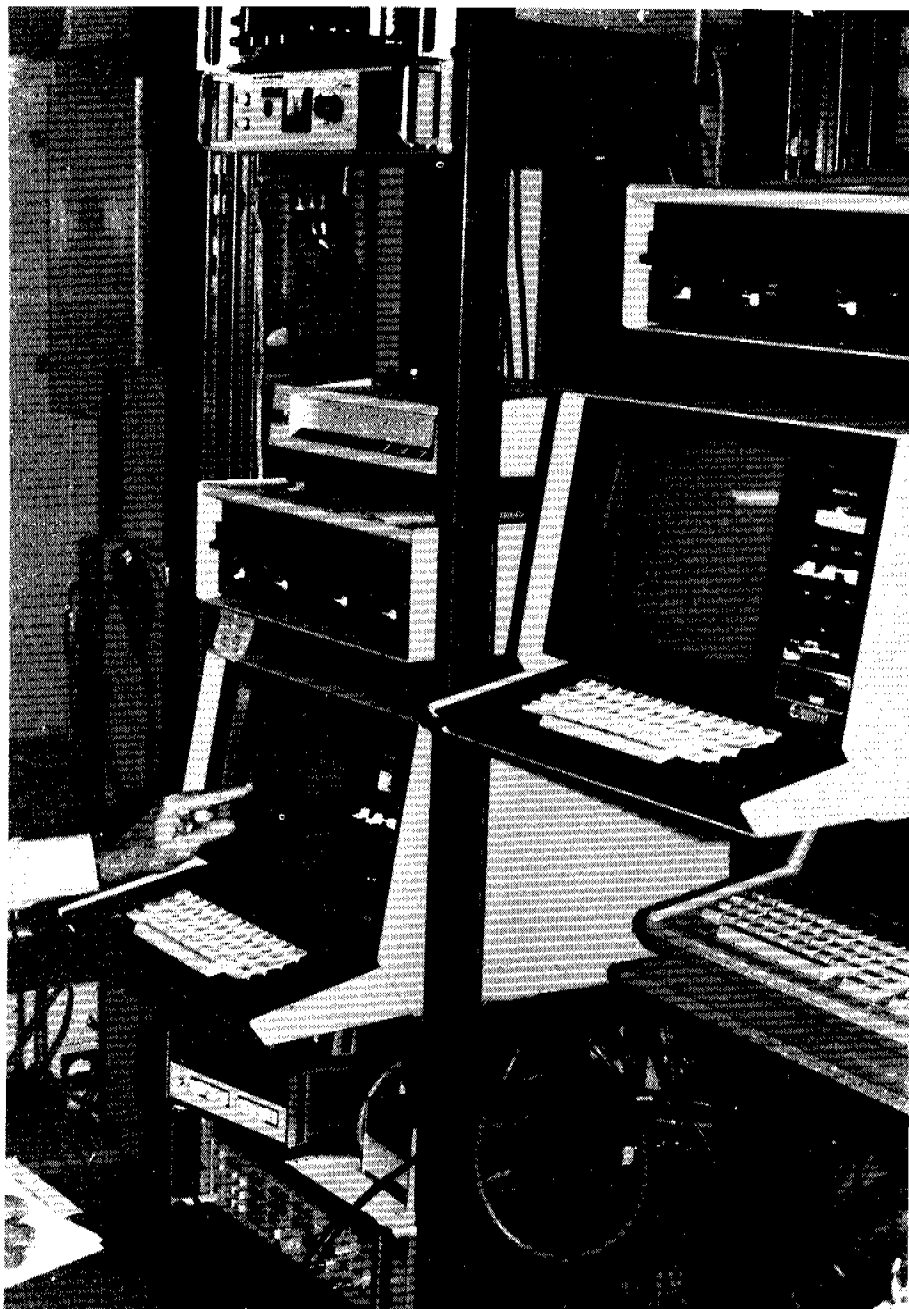
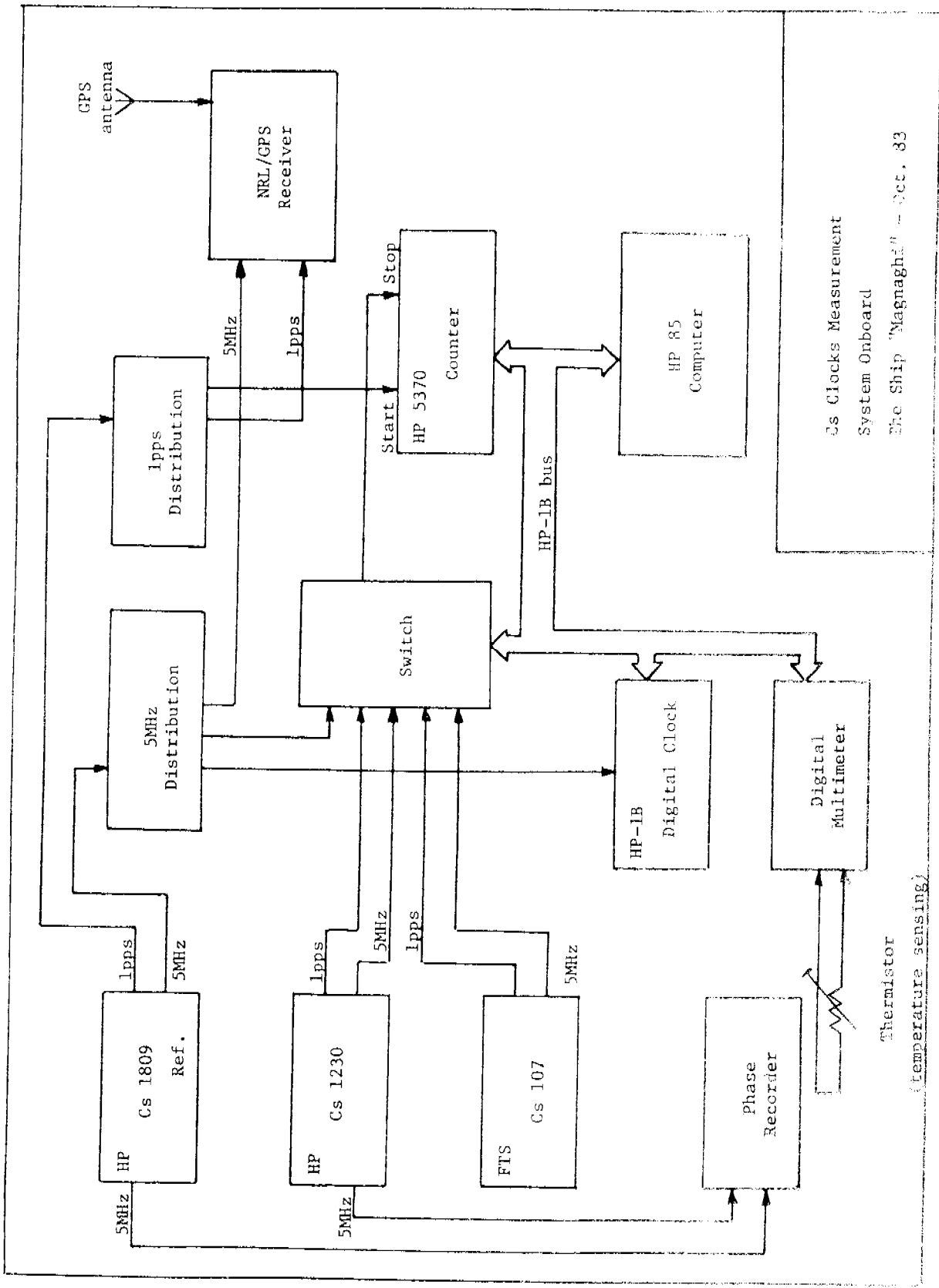

Fig. 5 - GPS time transfer receivers and data acquisition system (bottom)



Cs Clocks Measurement System Onboard The Ship "Magnaghi" - Oct. 83

Fig. 6

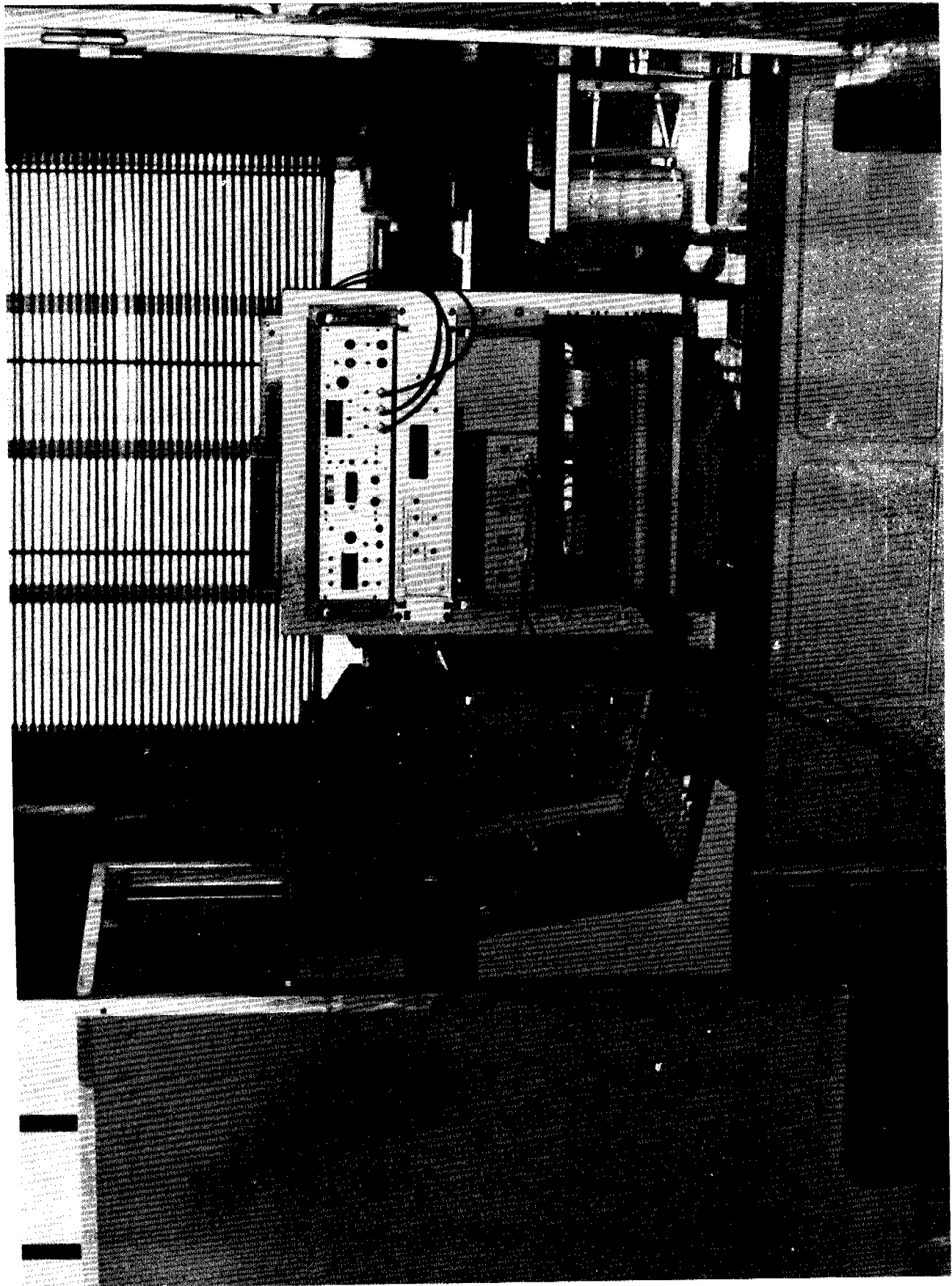
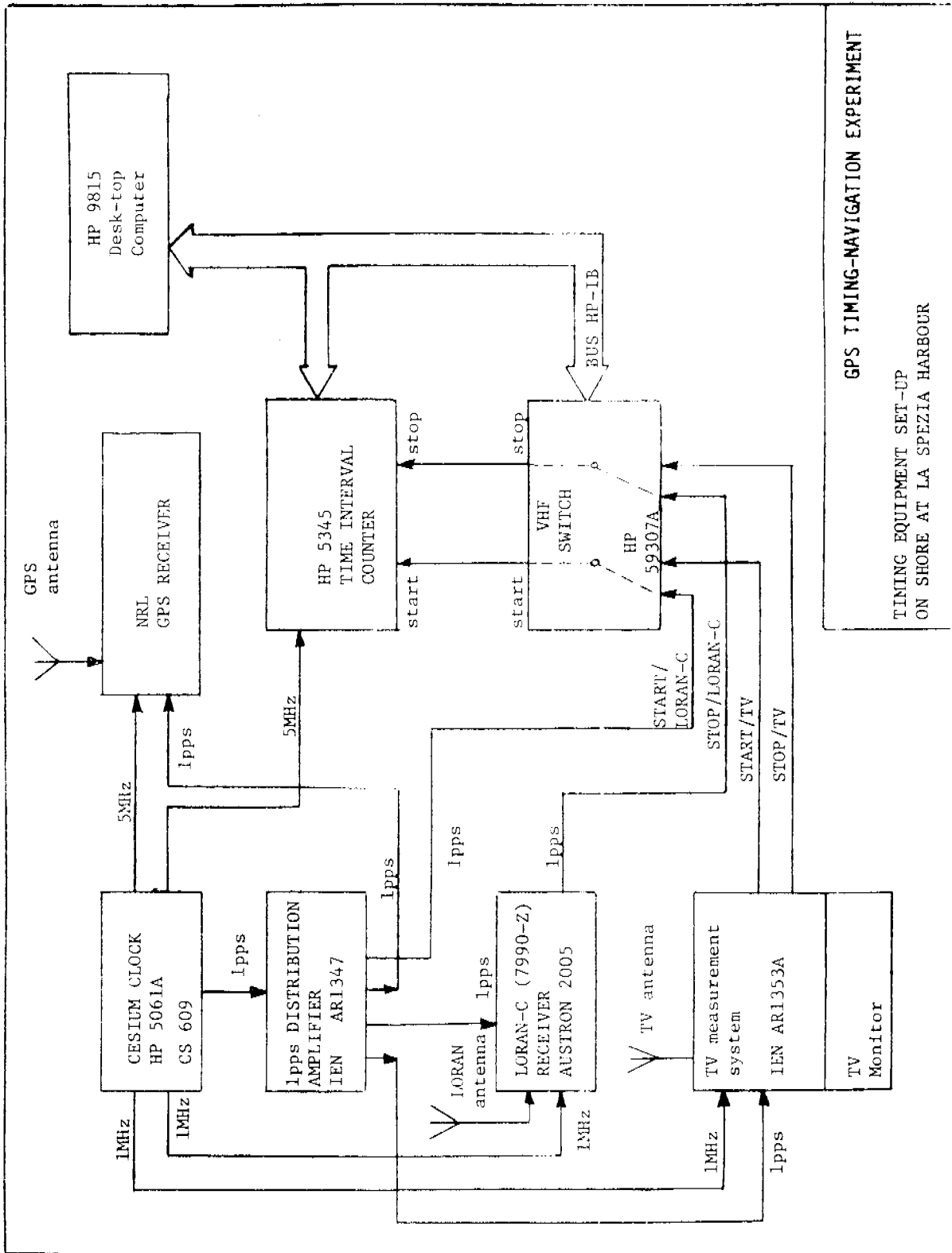

Fig. 7 - Back-up Timing System on shore (La Spezia)



GPS TIMING-NAVIGATION EXPERIMENT

TIMING EQUIPMENT SET-UP
ON SHORE AT LA SPEZIA HARBOUR

FIG. 8

DATA FILE - TIME COVERAGE

=====

DATA FILE	DAY (October)	Start time (Z)	Stop time (Z)	
DATA1	4/5	1804	0325	
DATA2	5	0712	1356	
DATA3	5/6	1441	0012	
DATA4	6/7	1253	0048	(*)
DATA5	7	0247	1707	(*)
DATA6	8	1145	1803	
DATA7	10	0309	1431	
DATA8	10/11	1630	0743	
DATA9	11/12	0746	0133	

 NOTE: (*) - Uncertain time tagging

TABLE I

DATA SET	NUMBER OF POINTS	FREQUENCY OFFSET		σ_f		FREQUENCY OFFSET UNCERTAINTY (95%) (ns/day)	σ_{fit} (ns)
		(μ s/min)	(ns/day)	(μ s/min)	(ns/day)		
1F	19	1.431	10^{-4}	3.297	10^{-6}	± 8.2	2.5
		206.1		4.7			
2F	14	1.441	10^{-4}	3.619	10^{-6}	± 9.3	1.7
		207.5		5.2			
3F	20	1.393	10^{-4}	1.444	10^{-6}	± 3.6	1.2
		200.6		2.1			
4F	23	1.441	10^{-4}	1.030	10^{-6}	± 2.6	1.0
		207.6		1.5			
5F	15	1.423	10^{-4}	2.776	10^{-6}	± 7.1	1.5
		204.9		4.0			
6F	13	9.171	10^{-5}	5.265	10^{-6}	± 13.6	2.2
		132.1		7.6			
7F	11	1.348	10^{-4}	2.199	10^{-6}	± 5.8	1.4
		194.0		3.2			

TABLE IIa PORTABLE CLOCK CS1809 - CS107 EVALUATION

* FREQUENCY PREDICTION TABLE *

DATA SET	NUMBER OF POINTS	FREQUENCY OFFSET		σ_f		FREQUENCY OFFSET UNCERTAINTY (95%) (ns/day)	σ_{fit} (ns)
		(μ s/min)	(ns/day)	(μ s/min)	(ns/day)		
8F	30	1.369	10^{-4}	1.413	10^{-6}	± 3.5	2.1
		197.1		2.0			
9F	9	1.167	10^{-4}	5.622	10^{-6}	± 15.3	1.3
		168.0		8.1			
9FA	17	1.418	10^{-4}	2.742	10^{-6}	± 6.9	1.7
		204.2		3.9			

TABLE IIB PORTABLE CLOCK CS1809 - CS107 EVALUATION

* FREQUENCY PREDICTION TABLE *

DATA SET	NUMBER OF POINTS	FREQUENCY OFFSET		σ_f		FREQUENCY OFFSET UNCERTAINTY (95%) (ns/day)	σ_{fit} (ns)
		(μ s/min)	(ns/day)	(μ s/min)	(ns/day)		
1F	19	5.450	10^{-5}	1.974	10^{-6}	+ 4.9	1.5
		78.5		2.8			
2F	14	1.353	10^{-4}	3.165	10^{-6}	+ 8.2	1.5
		194.8		4.6			
3F	20	1.049	10^{-4}	3.219	10^{-6}	+ 8.0	2.6
		151.0		4.6			
4F	24	8.458	10^{-5}	8.396	10^{-7}	+ 2.1	0.9
		121.8		1.2			
5F	15	-2.411	10^{-4}	2.592	10^{-5}	+66.1	14.0
		(#)	-347.2	37.3			
6F	13	6.327	10^{-5}	4.116	10^{-6}	+10.6	1.8
		91.1		5.9			
7F	13	8.791	10^{-5}	2.882	10^{-6}	+ 7.5	2.5
		126.6		4.1			

TABLE IIIa
 PORTABLE CLOCK CS1809 - CS1230
 EVALUATION
 Note
 (#) - Frequency change
 * FREQUENCY PREDICTION TABLE *

DATA SET	NUMBER OF POINTS	FREQUENCY OFFSET		σ_f		FREQUENCY OFFSET UNCERTAINTY (95%) (ns/day)	σ_{fit} (ns)
		(μ s/min)	(ns/day)	(μ s/min)	(ns/day)		
8F	31	7.025	10^{-5}	1.328	10^{-6}	+ 3.2	2.0
		101.2		1.9			
9F	26	1.203	10^{-4}	2.932	10^{-6}	\pm 7.2	5.3
		173.2		4.2			

TABLE IIIb PORTABLE CLOCK CS1809 - CS1230 EVALUATION

* FREQUENCY PREDICTION TABLE *

CS1809-CS107 FREQUENCY OFFSET EVALUATION

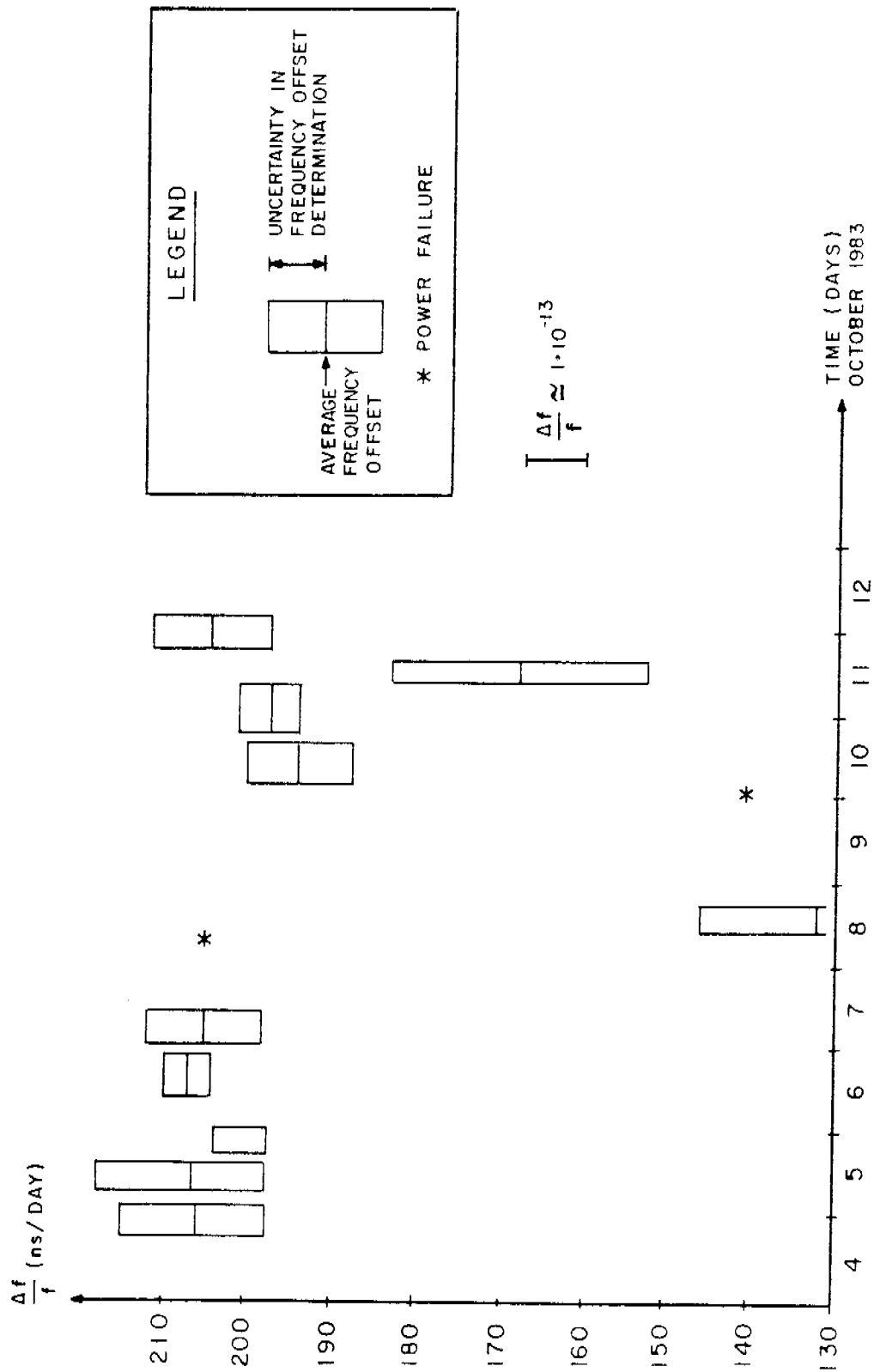
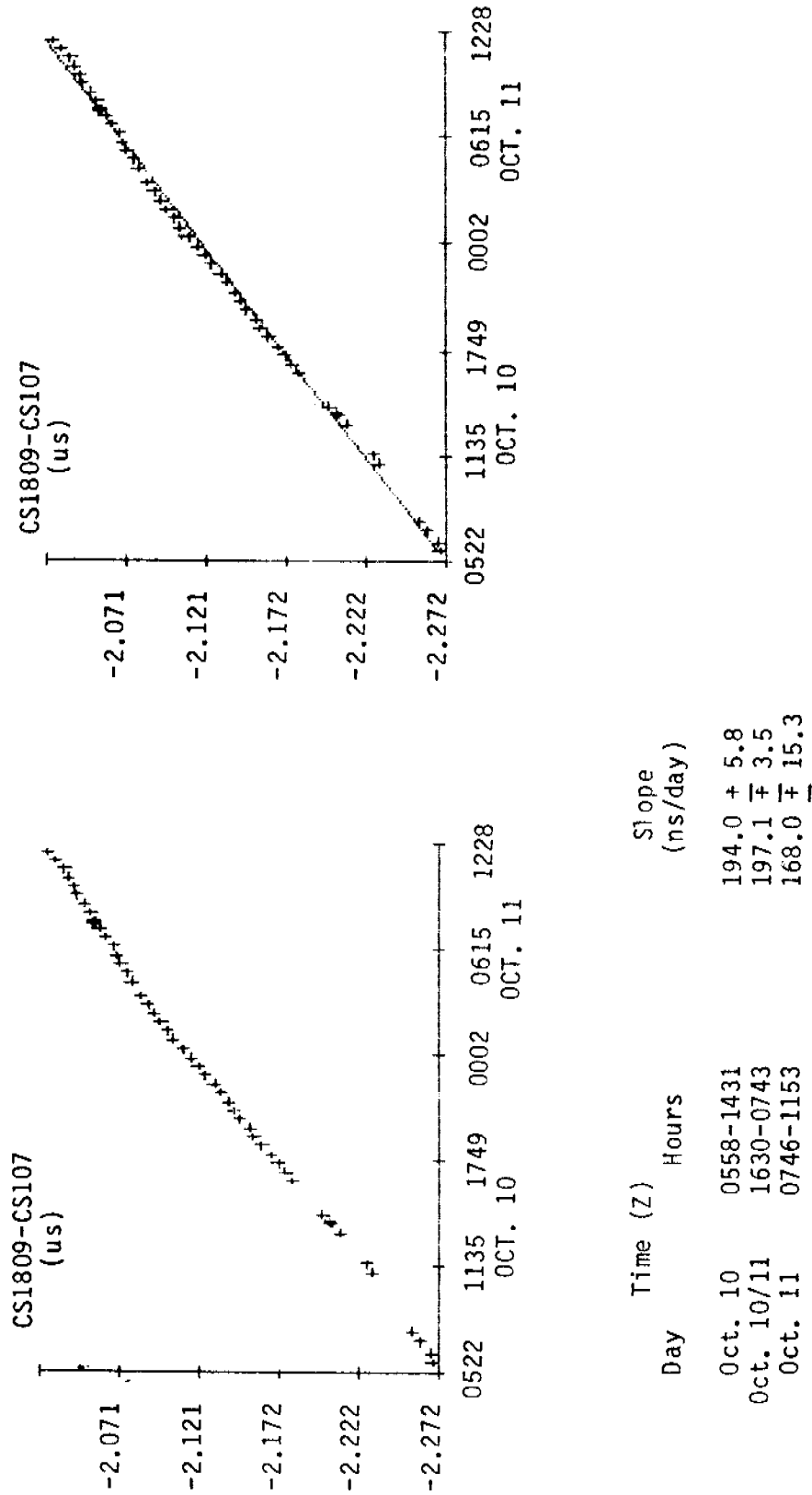

Fig. 9

CS 1809 - CS 107
=====



Average slope = 198.0 ± 2.6 (ns/day)

Fig. 10 INTERNATIONAL TIME TRANSFER AND PORTABLE CLOCK EVALUATION
USING GPS TIMING RECEIVERS

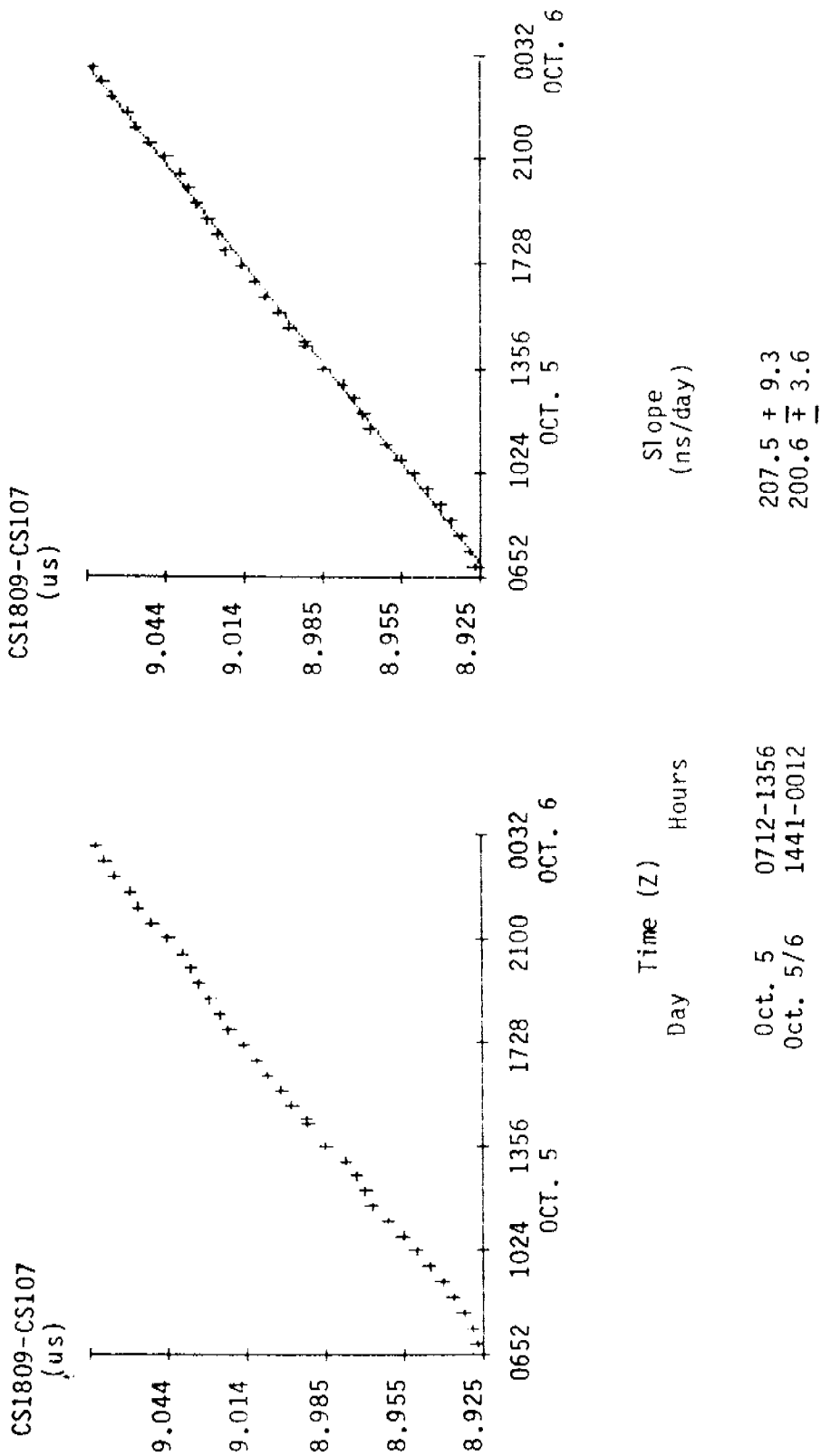

Average slope = 208.7 ± 2.3 ns/day

Fig. 11 - INTERNATIONAL TIME TRANSFER AND PORTABLE CLOCK EVALUATION USING GPS TIMING RECEIVERS

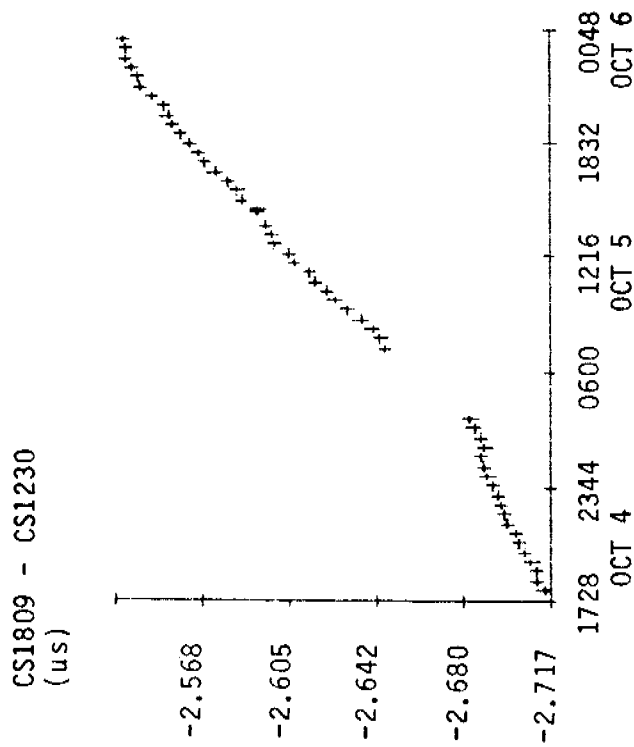
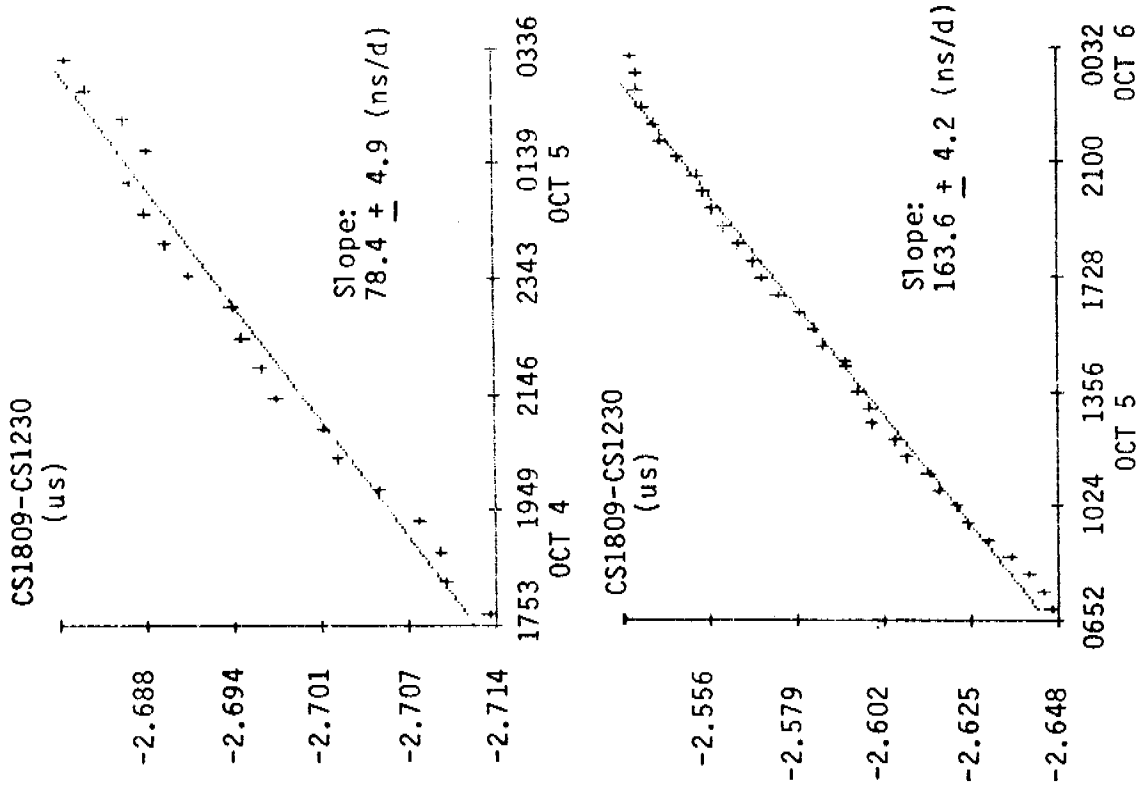

CS 1809 - CS 1230
 OCT 4 - OCT 6
 =====

FIG. 12 - INTERNATIONAL TIME TRANSFER AND PORTABLE CLOCK EVALUATION USING GPS TIMING RECEIVERS

CS1809-CS1230
(us)

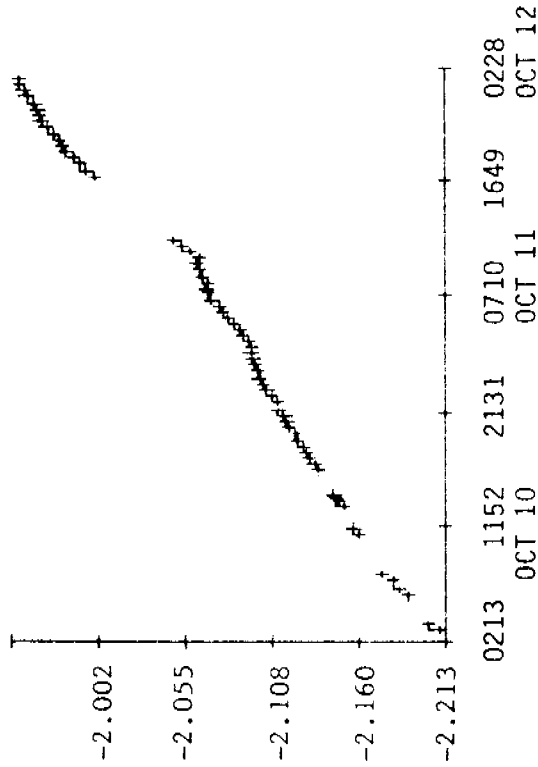

CS1809-CS1230
(us)

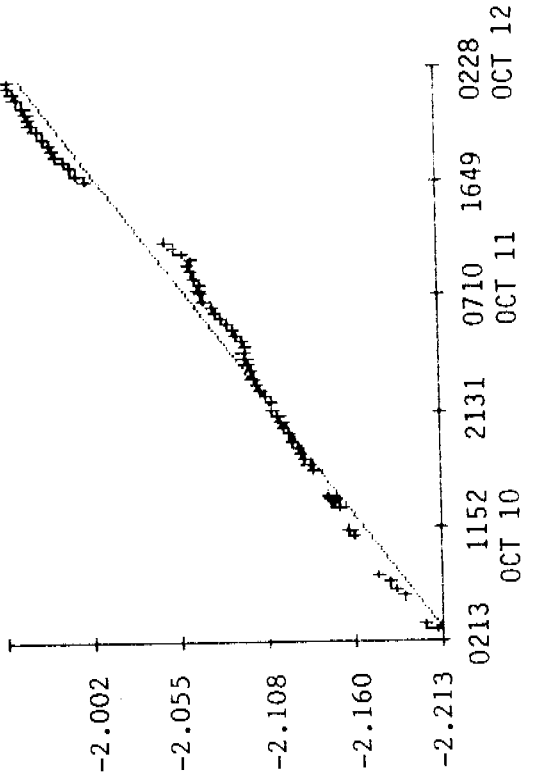

AVERAGE SLOPE = 129.04 ± 3.4 ns/day

Slope
(ns/day)

Time (Z)
Hours

Day	Time (Z) Hours	Slope (ns/day)
Oct. 10	0309-1431	126.6 ± 7.5
Oct. 10/11	1630-0743	101.2 ± 3.2
Oct. 11/12	0746-0133	173.2 ± 4.2

PORTABLE CLOCKS INTERCOMPARISON
CS 1809 - CS 1230

FIG. 13 - INTERNATIONAL TIME TRANSFER AND PORTABLE CLOCK EVALUATION
USING GPS TIMING RECEIVERS

PORTABLE CLOCKS INTERCOMPARISON
CS 1809 - CS 1230

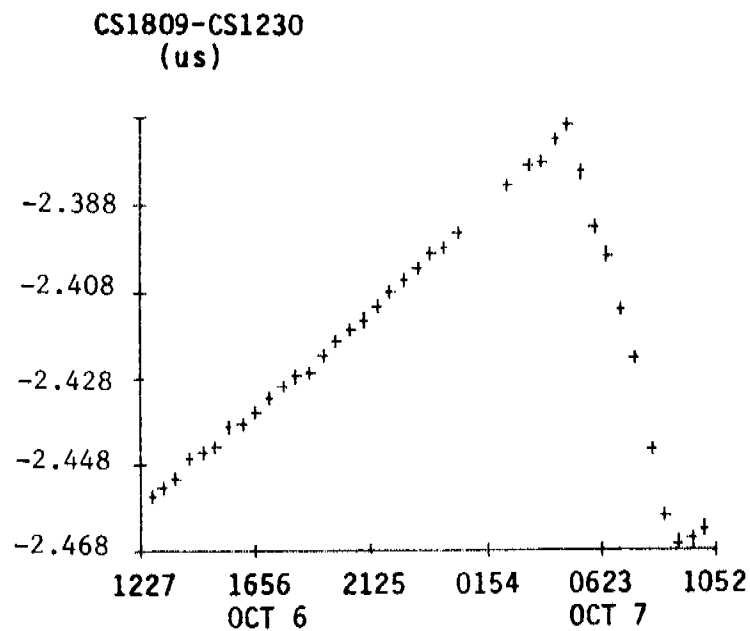

Slope = 121.9 ± 2.1 ns/day

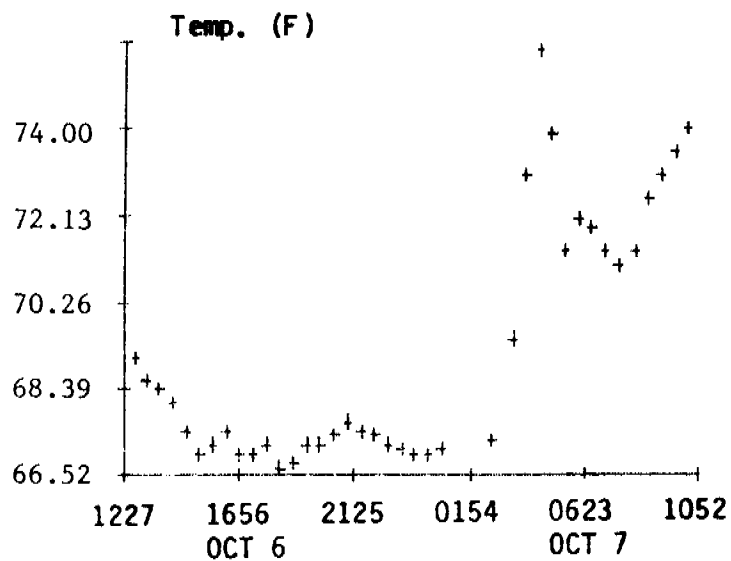

AVERAGE TEMPERATURE = 69.2 degrees (F)

FIG. 14 INTERNATIONAL TIME TRANSFER AND PORTABLE CLOCK EVALUATION
USING GPS TIMING RECEIVERS

CLOCKS STATISTICS TABLE

=====

CS 1809 - CS 107 (\$)

- * AVERAGE FRACTIONAL FREQUENCY OFFSET = 198.9 ns/day
- * STANDARD DEVIATION = 12.50 ns/day = $1.4 \cdot 10^{-13}$
- * MAXIMUM FREQUENCY OFFSET = 207.6 ns/day
- * MINIMUM FREQUENCY OFFSET = 168.0 ns/day
- * RANGE (MAXIMUM - MINIMUM) = 39.6 ns/day

CS 1809 - CS 1230

- * AVERAGE FRACTIONAL FREQUENCY OFFSET = 129.8 ns/day
(1 point filtered)
- * STANDARD DEVIATION = 40.67 ns/day = $4.7 \cdot 10^{-13}$
- * MAXIMUM FREQUENCY OFFSET = 194.8 ns/day
- * MINIMUM FREQUENCY OFFSET = 78.5 ns/day
- * RANGE (MAXIMUM - MINIMUM) = 116.3 ns/day

Note:

(\$) - Days Oct. 8 and 9 were not considered (two power failures)

 *
 * SYNCHRONIZATION LINKS CAPABILITIES *
 *

Link	Expected accuracy	Comments
PORTABLE CLOCKS	10-100 ns	Degrading with elapsed time
GPS RECEIVERS	50-100 ns	Worldwide
LORAN-C	100 ns	Local (between IEN and La Spezia)
LORAN-C	1-10 us	Intercontinental (between IEN and USNO)
TV	10-50 ns	Local (between IEN and La Spezia)
TRANSIT	10-30 us	Worldwide
CS CLOCKS INTERCOMPARISON	1-5 ns	Local (within the same laboratory)

GPS TIMING-NAVIGATION EXPERIMENT

REAL-TIME SYNCHRONIZATION LINKS

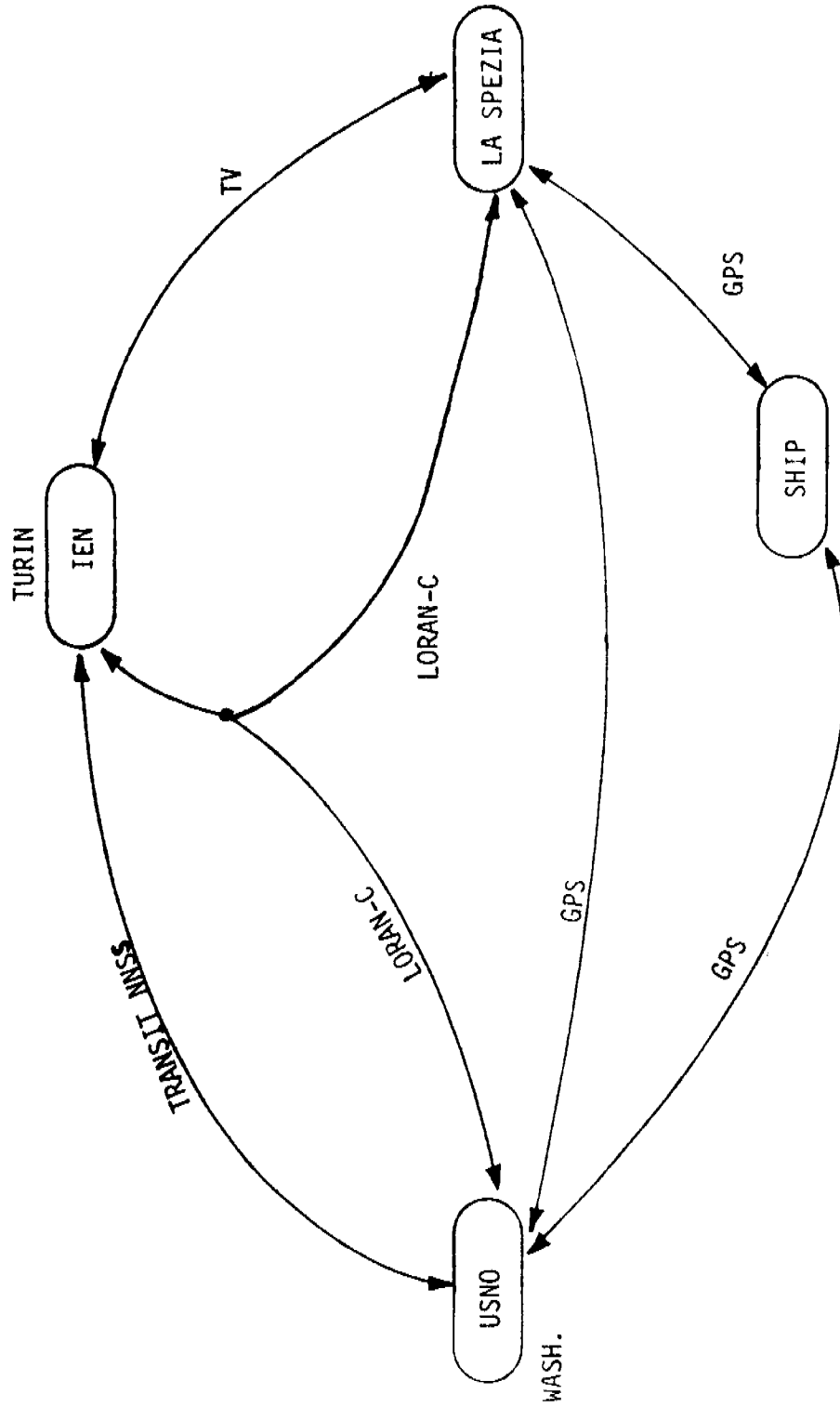
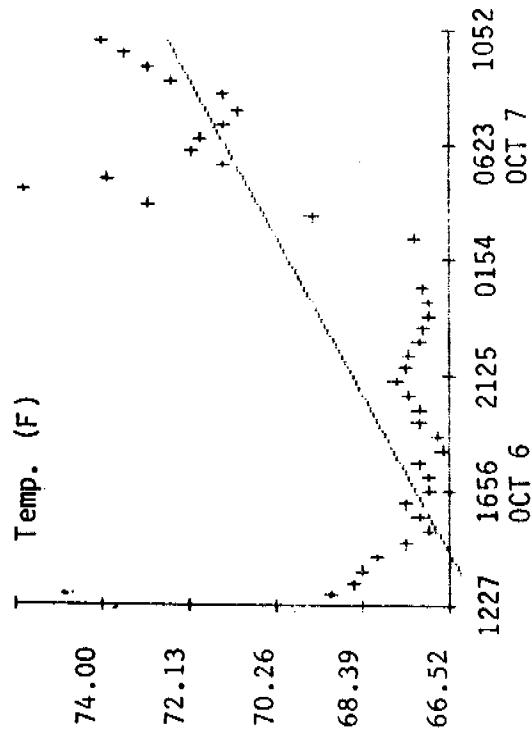
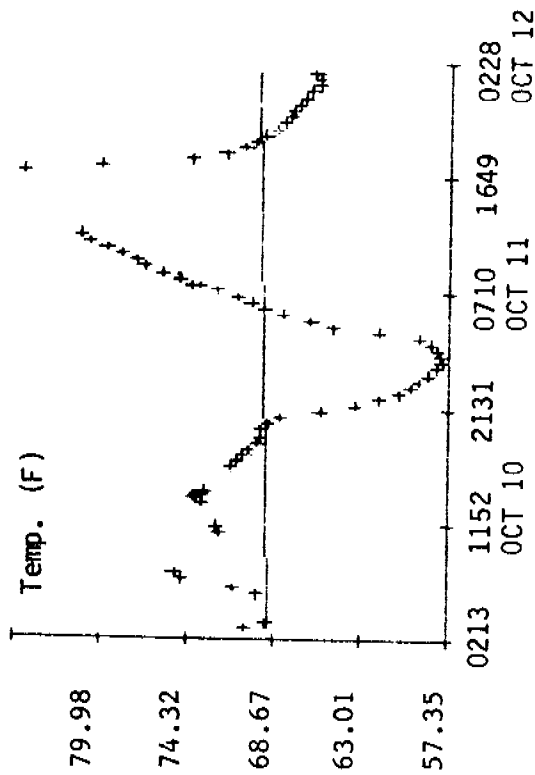

FIG. 15



AVERAGE TEMPERATURE = 69.2 degrees (F)
 AVERAGE TREND = + 7.2 degrees (F)/day



AVERAGE TEMPERATURE = 69.5 degrees (F)
 AVERAGE TREND = + 0.35 degrees (F)/day

 TEMPERATURE ANALYSIS

FIG. 16 - INTERNATIONAL TIME TRANSFER AND PORTABLE CLOCK EVALUATION
 USING GPS TIMING RECEIVERS

TEMPERATURE ANALYSIS CHART

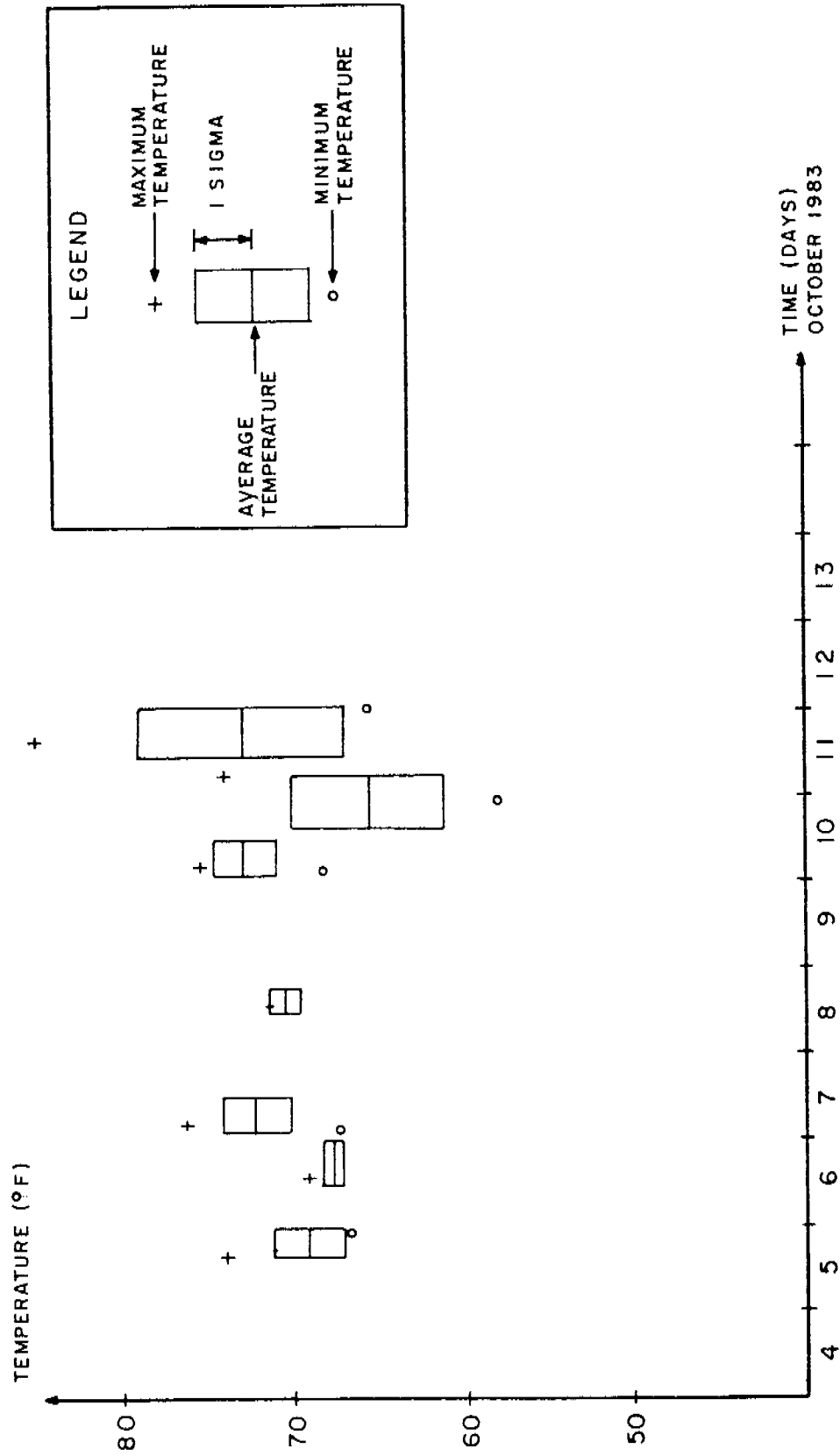
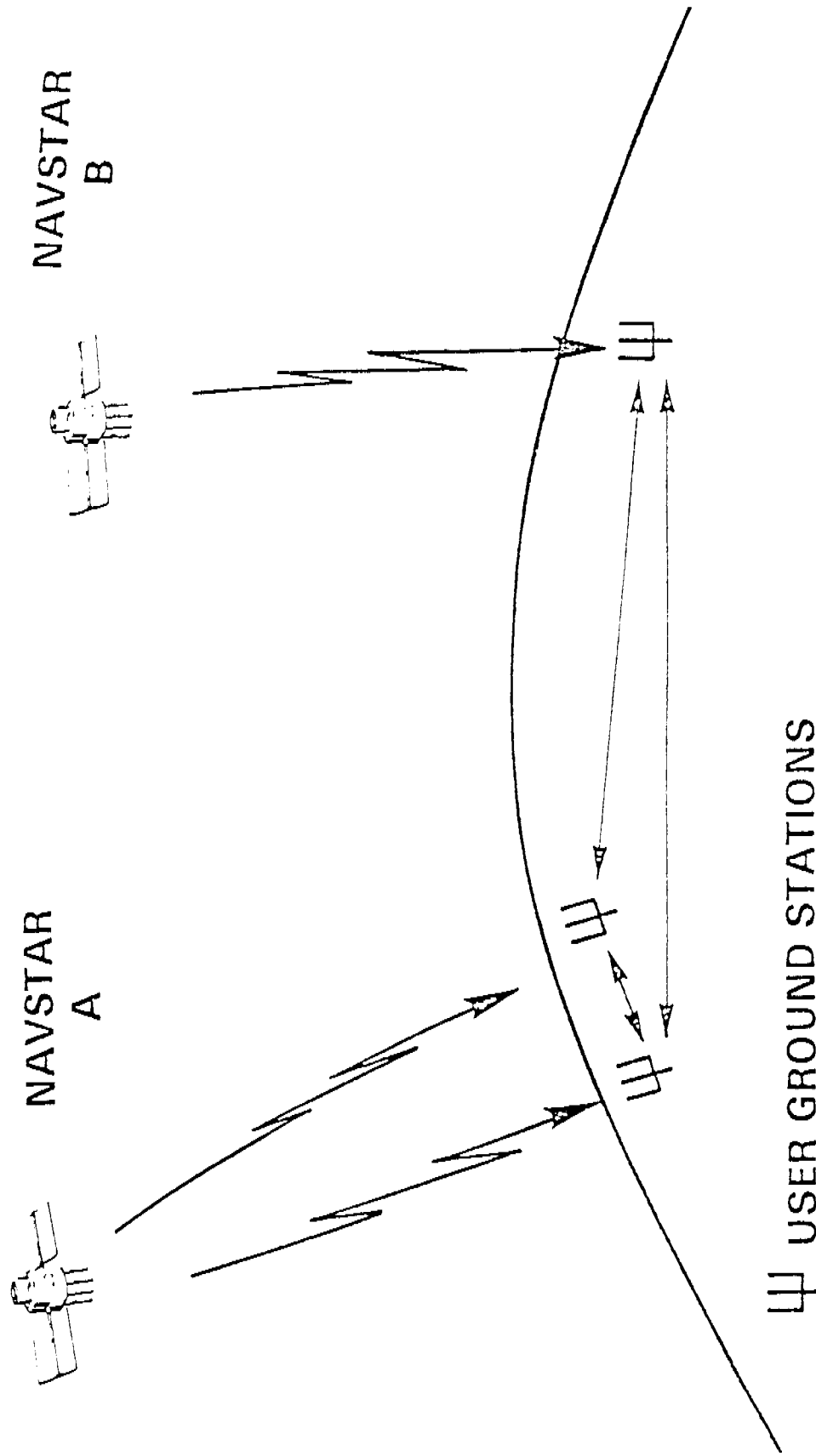

Fig. 17

TEMPERATURE STATISTICS
 =====

DAY	Start time (Z)	Stop time	Average Temperature	Standard Deviation	Max Temp.	Min Temp.	Max-Min
(October)							
5/6	1441	0012	69.14	2.11	72.8	66.9	5.90
6/7	1253	0048	67.41	0.59	69.1	66.7	2.40
7	0247	1707	72.2	1.9	75.7	67.3	8.4
8	1145	1803	70.5	0.7	71.4	69.4	2.0
10	0309	1431	72.6	1.8	75.2	69.2	6.0
10/11	1630	0743	65.4	5.4	73.6	57.9	15.7
11/12	0746	0133	72.8	5.8	85.1	65.9	19.2



U USER GROUND STATIONS

FIG. 18
 NAVSTAR GPS Station Synchronization by Time Transfer

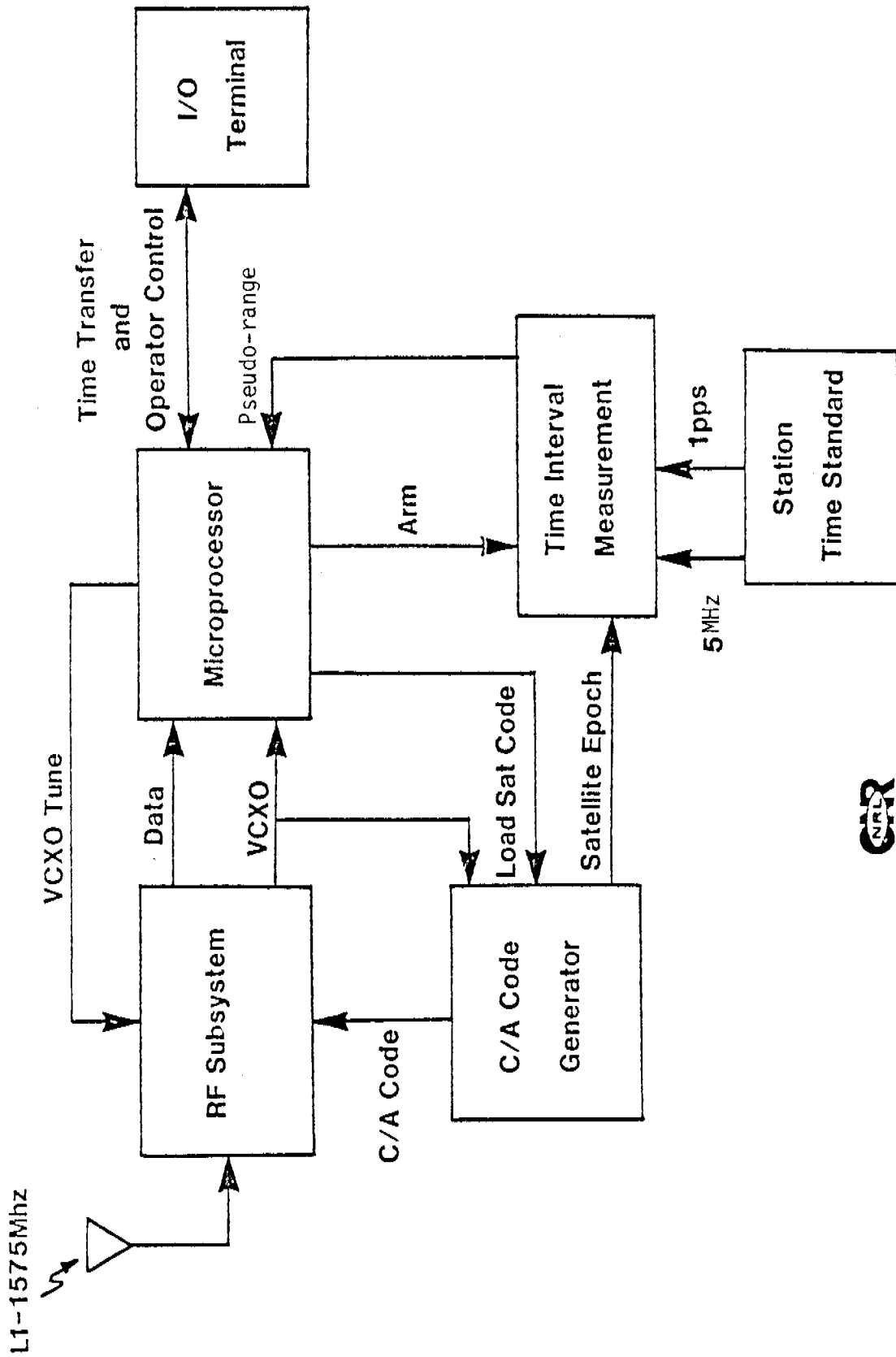
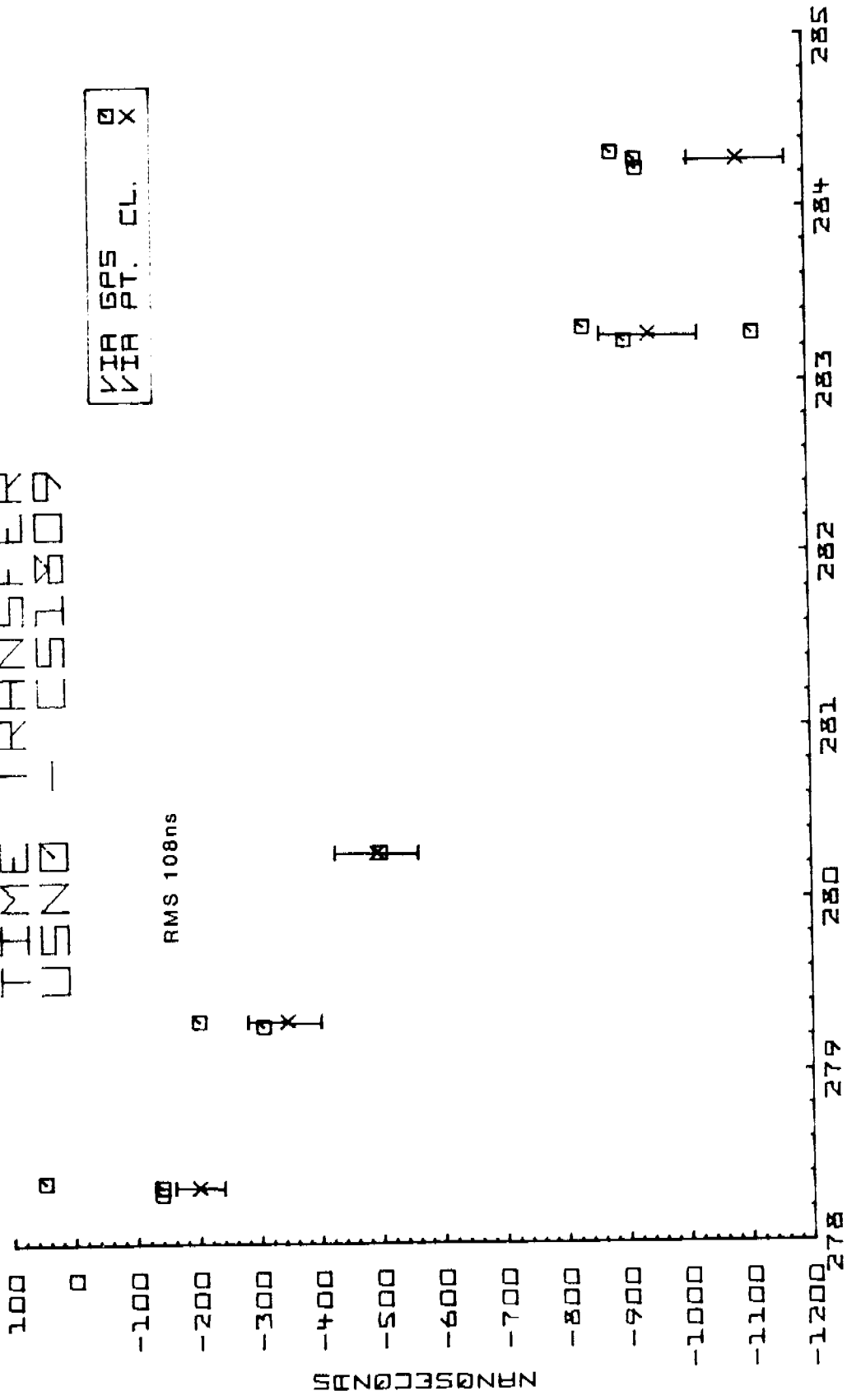

Fig. 19
GPS Time Transfer Receiver Block Diagram

MOVING SHEET TIME - ASSISTOR

VIA PPS CL. X



MAY - 1983

Fig. 20

EQUIPMENT SET-UP AT IEN DURING THE GPS EXPERIMENT 13-20 OCT 1983

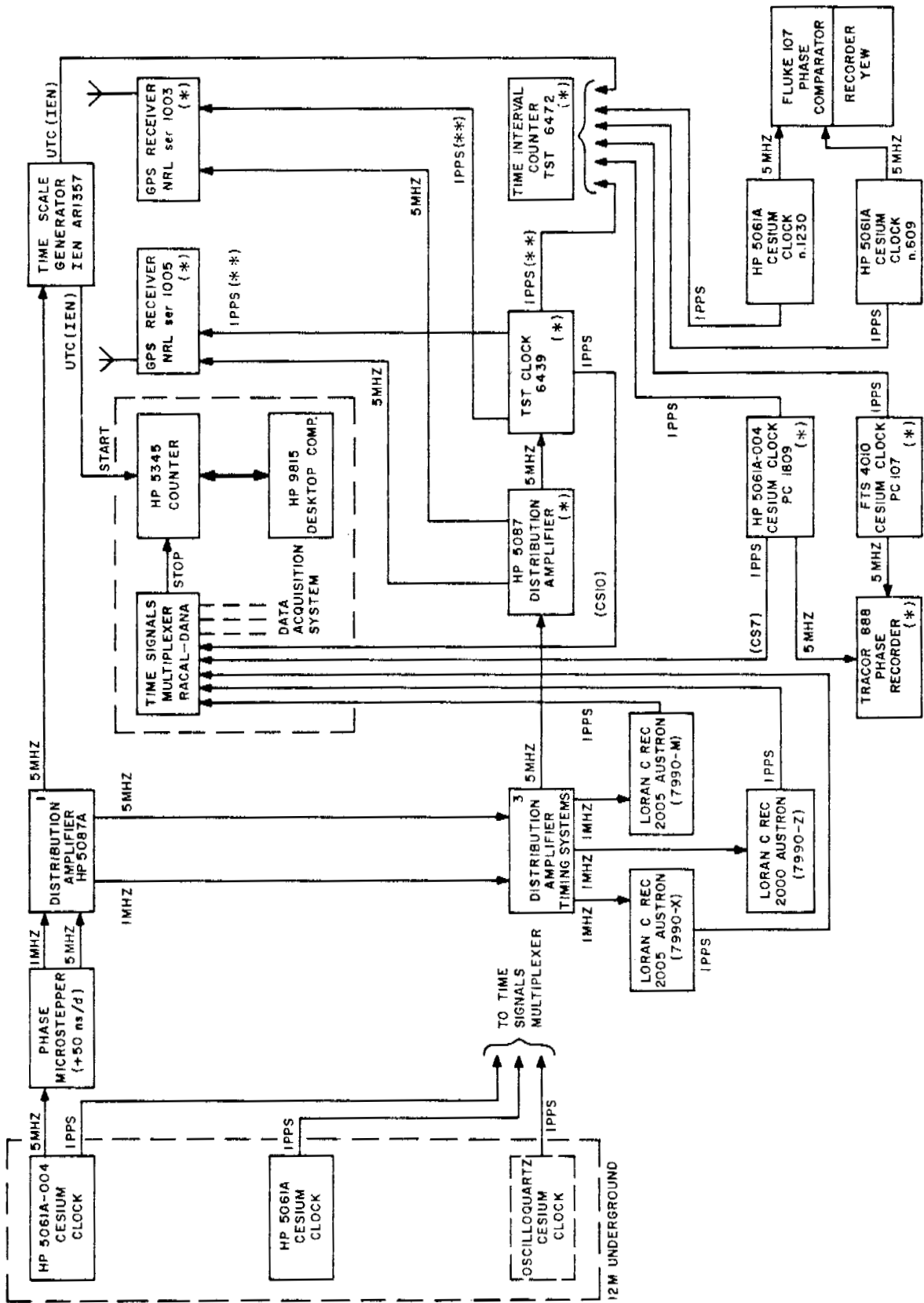

(*) U.S. EQUIPMENT
 (**) 1PPS ≡ UTC (IEN)

FIG. 21

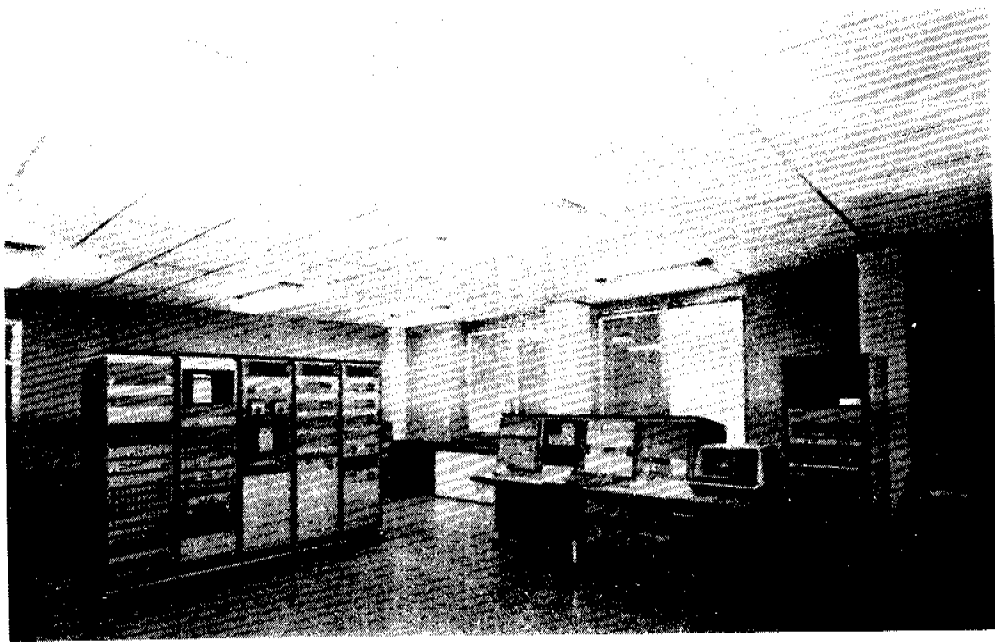

Fig. 22 - The Time-keeping facilities at IEN (Torino)

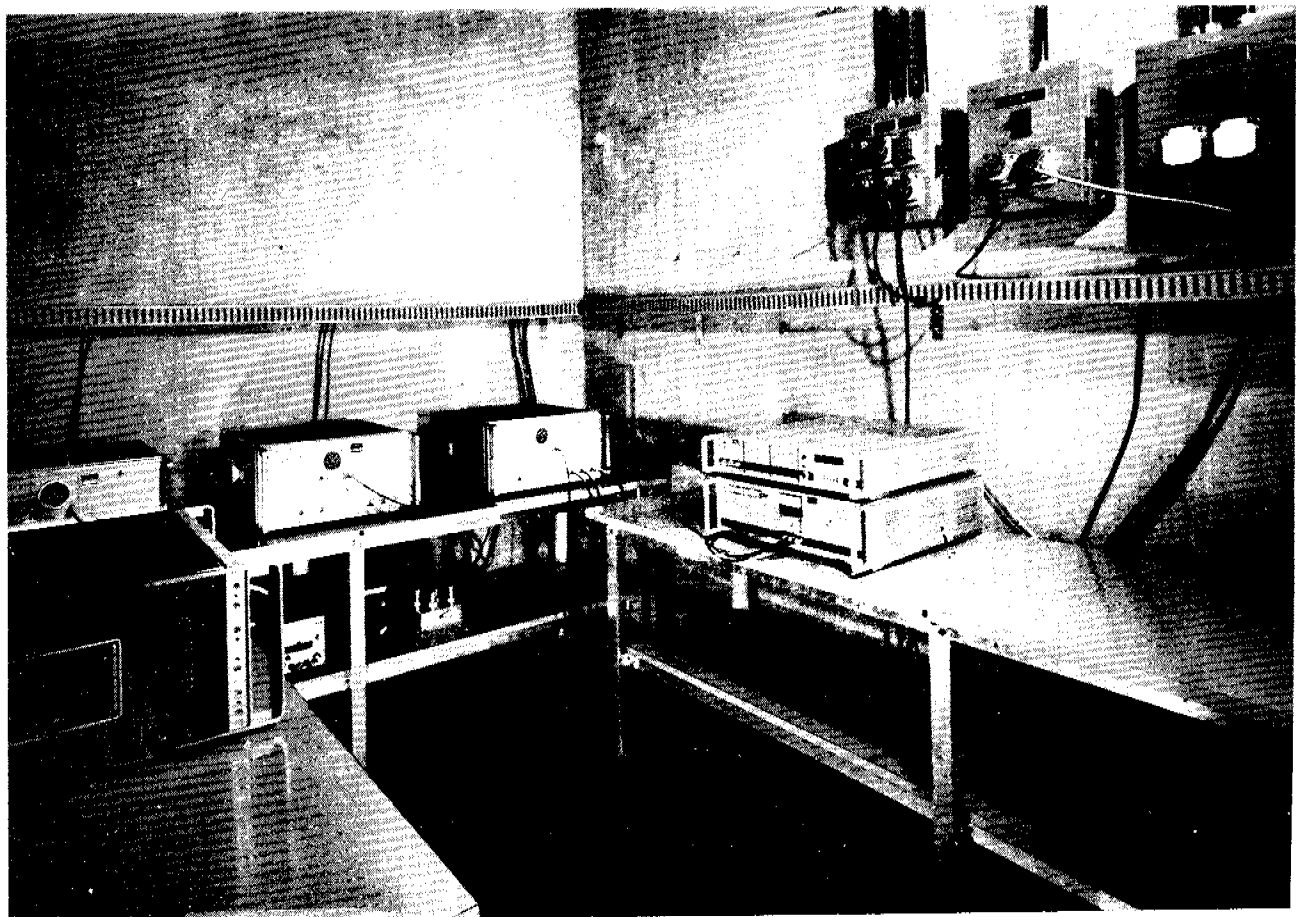

Fig. 23 - Underground clock vault at IEN

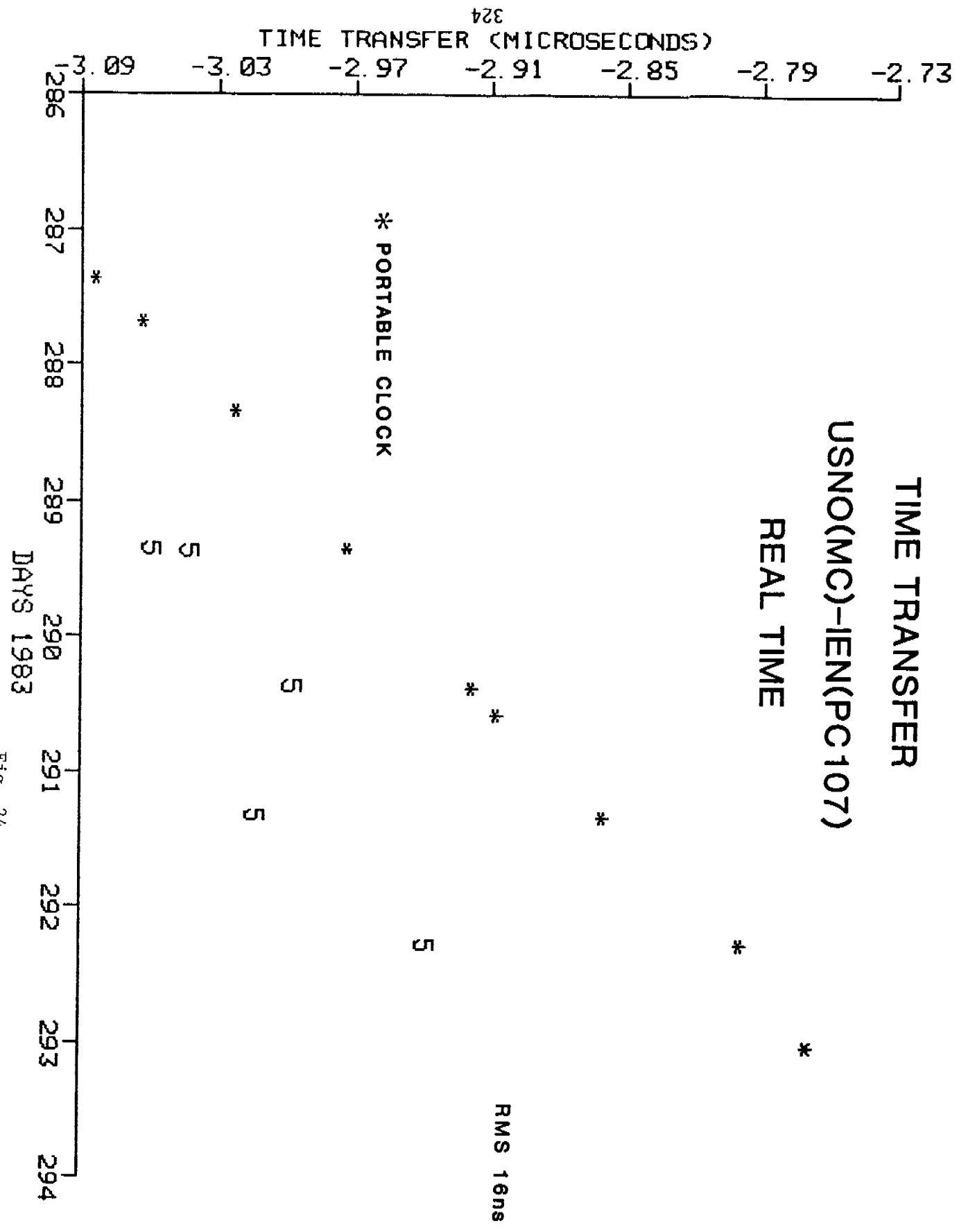

Fig. 24

TIME TRANSFER
 USNO(MC)-IEN(PC107)
 PRECISE

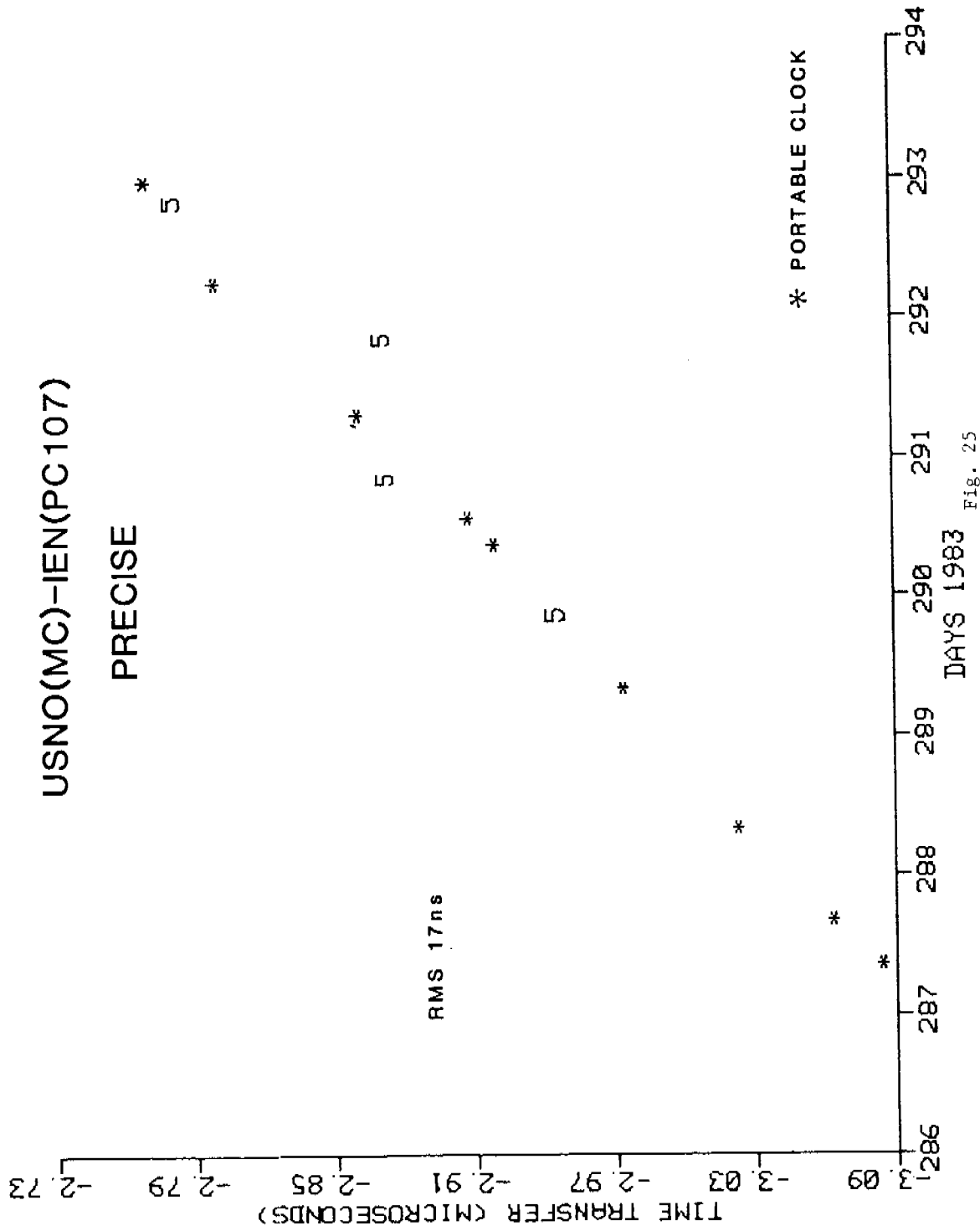

Fig. 25

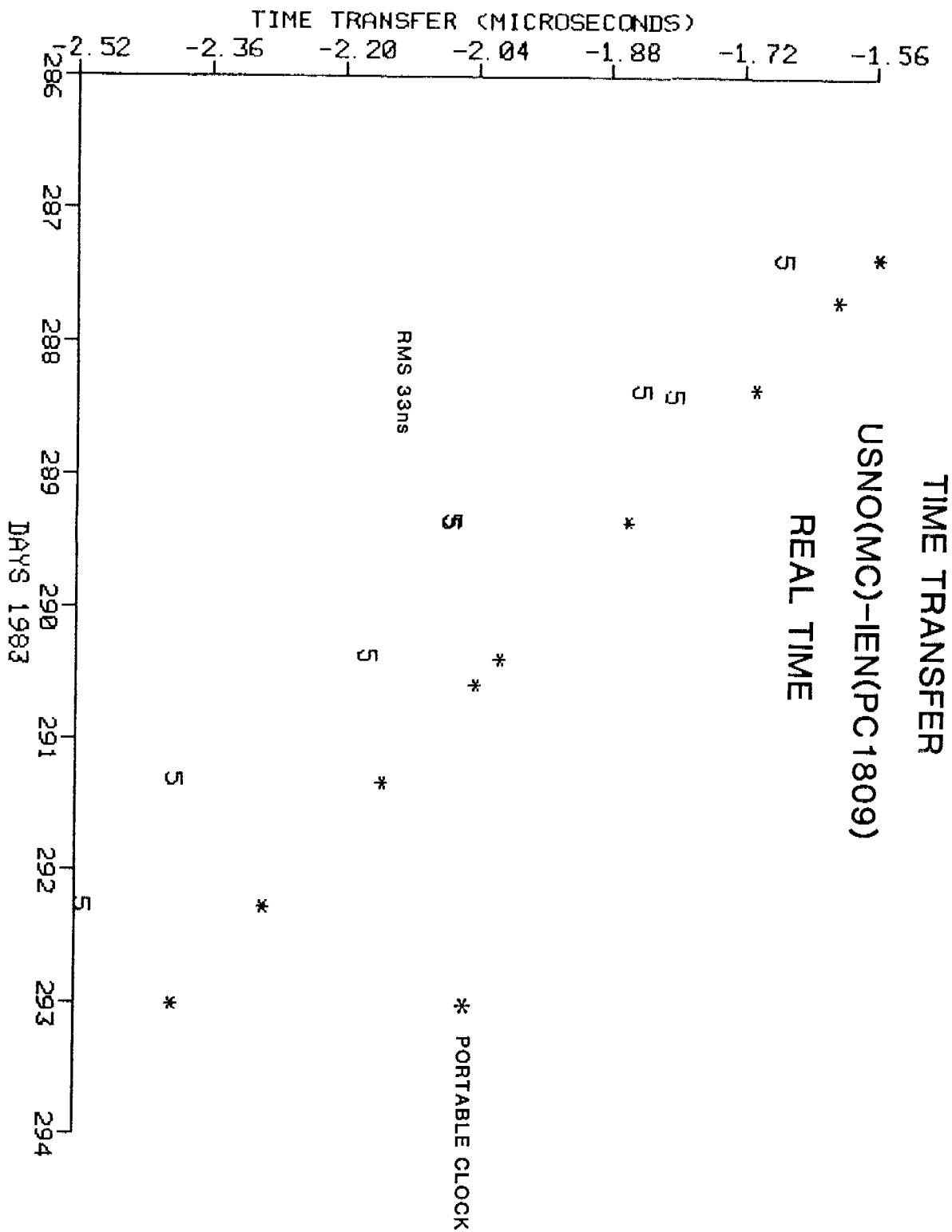

Fig. 26

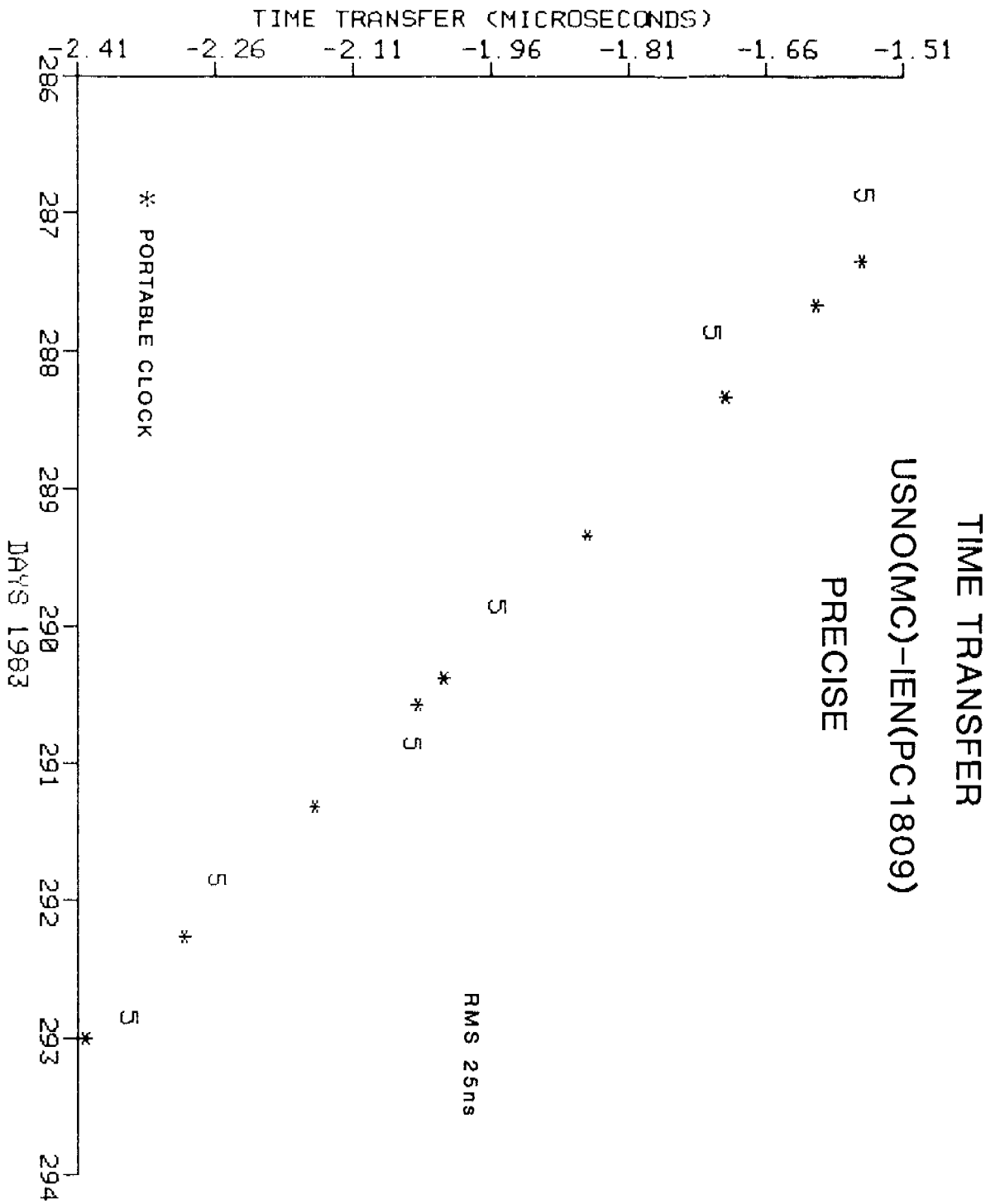

Fig. 27

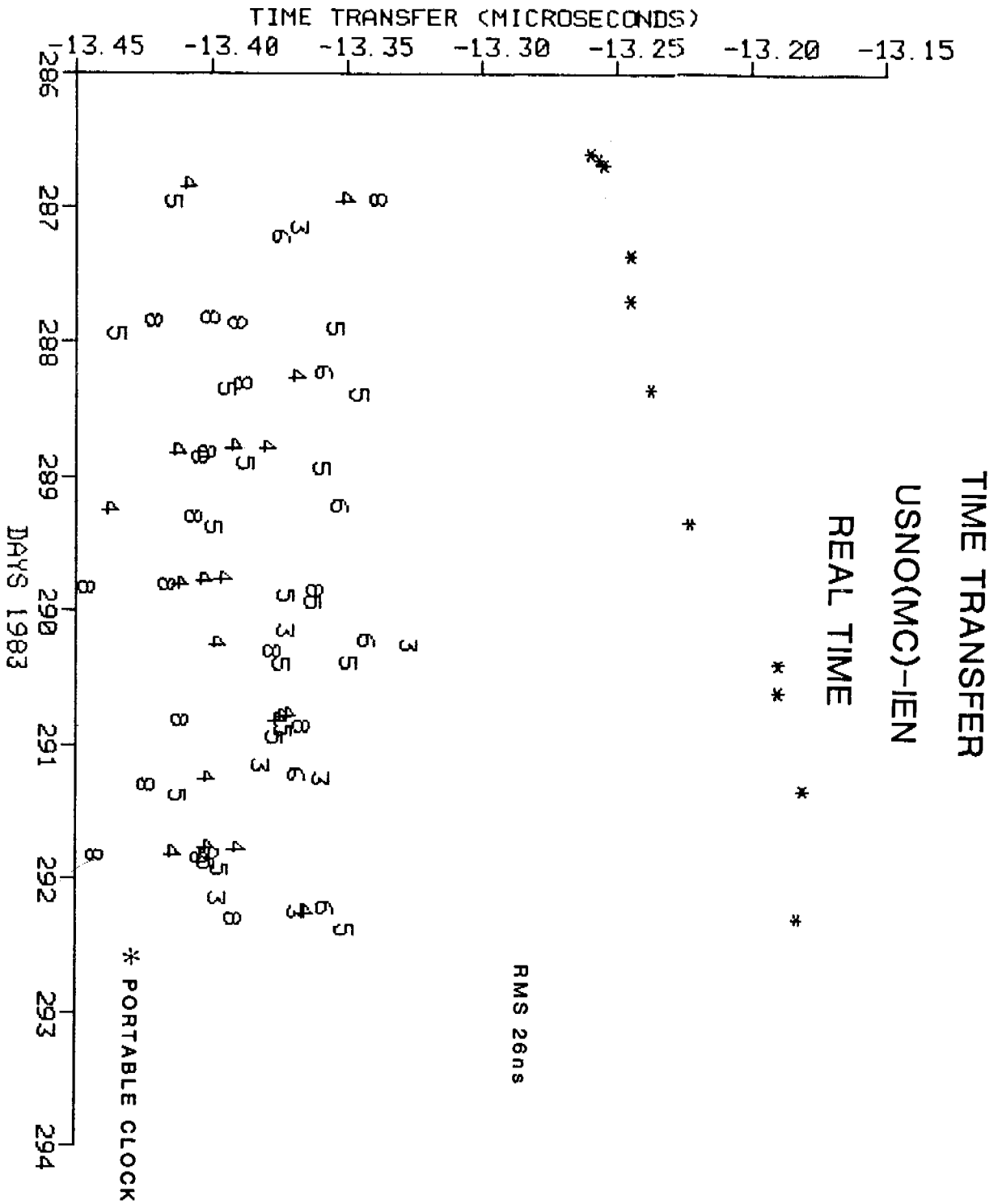

Fig. 28

QUESTIONS AND ANSWERS

MR. JOHNSON:

Andy Johnson, Naval Observatory. Could that thirty meters be reduced by repeated observations over several days from the G.P.S.?

MR. DETOMA:

Yes. As was shown yesterday, the positioning accuracy is much better than the navigation accuracy. This is for a lot of reasons. Also, not only for inaccuracy of the measurement itself, but also for the reason to maintain a straight course of the ship during the period of time between thirty minutes and one hour.

So you can expect an improvement in the order of magnitude, well, probably not in the order of--but at least three times when you perform the synchronization without knowing your position in a fixed site. The results I presented at the I.E.N. were obtained by using the coordinates that were given in the WGS-72 System. But, as was shown yesterday, they were not significantly different from the coordinates obtained from the positioning solution from the receiver.

They were different, if I remember, around ten to fifteen meters maximum in longitude, and less than ten meters in latitude. In average, they were less than ten meters in absolute position. So you can expect almost as good result as was presented here, in a fixed position; but for the time synchronization aboard the ship, we were talking about synchronizing clock while the ship was moving, which is a completely different environment.