

## PRECISE TERRESTRIAL TIME-A MEANS FOR IMPROVED BALLISTIC MISSILE GUIDANCE ANALYSIS

Eldon E. Ehram (Space And Missile Test Center),  
Stephen A. Cresswell, George R. McKelvey, and  
Frank L. Matthews (ITT Federal Electric Corpor-  
ation), Vandenberg AFB, California

### ABSTRACT

Significant improvements in ballistic missile guidance performance has necessitated the guidance systems analysis community to adopt more precise timing standards for the evaluation of test data. To date, data timing is achieved at the ground instrumentation sites since the missile dynamics are too demanding for currently available high precision missile borne timing sources. In the past five years as noted in the 1973 PTTI paper, "Precise Timing Correlation in Telemetry Recording and Processing Systems", accuracy improvements in evaluation of guidance systems were expected to exceed the IRIG timing techniques used in time tagging guidance telemetry data. An approach developed by Space and Missile Test Center (SAMTEC) to improve the ground instrumentation time tagging accuracy has been adapted to support the Minuteman ICBM program and has been designated the Timing Insertion Unit (TIU). The TIU technique produces a telemetry data time tagging resolution of one tenth of a microsecond, with a relative intersite accuracy after corrections to better than 0.5 microsecond. Metric tracking position and velocity data (range, azimuth, elevation and range rate) also used in missile guidance system analysis can be correlated to within ten microseconds of the telemetry guidance  $x$ ,  $y$ ,  $z$  and  $\dot{x}$ ,  $\dot{y}$ ,  $\dot{z}$  data. This requires precise timing synchronization between the metric and telemetry instrumentation sites. The timing synchronization can be achieved by using the radar automatic phasing system time correlation methods. Other time correlation techniques such as Television (TV) Line-10 and the Geostationary Operational Environmental Satellites (GOES) terrestrial timing receivers are being considered. With the continuing improvement of ballistic missile guidance performance, on-board clocking stability of one part in  $10^9$  may be required. This increased on-board stability will influence improvements in terrestrial time precision and accuracy.

## INTRODUCTION

The Air Forces Space and Missile Test Center (SAMTEC), headquartered at Vandenberg Air Force Base, California, manages, operates and maintains the Western Test Range (WTR) and the Eastern Test Range (ETR) in support of Department of Defense (DOD), National Aeronautics and Space Administration (NASA) and other ballistic, space and aeronautical user programs. Figure 1 shows the geographical area of the WTR which extends from the west coast to 90 degrees East longitude in the Indian Ocean and includes instrumentation support provided by the U.S. Navy Pacific Missile Test Center (PMTC), NASA, U.S. Air Force Satellite Control Facility (AFSCF) and the U.S. Army Kwajalein Missile Test Range (KMR). This paper describes the application of precise time synchronization techniques by SAMTEC to provide support for DOD ballistic weapon system user programs with a need to achieve improved ballistic missile inertial guidance system analysis. The SAMTEC has determined through analysis of inertial guidance telemetry data that the missile guidance system clock stability is affected by flight dynamics during the launch and post boost burn. Because of this clock stability problem, another means of providing timing synchronization was required. SAMTEC has recently designed and developed equipment and procedures which allow relative time synchronization between telemetry receiving sites to within 0.5 microsecond and the time tagging of recorded telemetry data to a resolution of 0.1 microsecond. Metric radar sites are synchronized to within one microsecond relative between radar sites and telemetry sites. Figure 2 shows the geographical relationship of westcoast uprange (SAMTEC and PMTC) telemetry receive sites and metric radar sites which support ballistic missiles launched from Vandenberg Air Force Base, California.

### Background

The need for a more accurate timing capability to time tag telemetry inertial guidance data came as an intrinsic result of the improved guidance performance. Timing accuracy requirements have gradually increased over the past few years from milliseconds in the early 1960's until today when the range user is requesting time resolutions to the tenth of a microsecond. Figure 3 shows the history of timing accuracy improvement implemented at WTR for time tagging of telemetered ballistic missile inertial guidance data.

As recent as only a few years ago, timing provided by the Inter-Range Instrumentation Group (IRIG) "B" codes were considered adequate for post flight reduction of telemetered pulse code modulation (PCM) data. With further improvements in ballistic missile guidance systems, WTR was required to distribute IRIG "A" time code format with a resolution of 100 microseconds. However, even with the higher timing carrier frequencies i.e., IRIG "G" with a 100 kilohertz carrier and a resolution of 10 microseconds, timing accuracy and precision were still found to be inadequate for the demands of inertial guidance accuracy analysis. This is primarily due to the methods of recording the timing on independent tracks of an analog tape recorder in parallel with the predetection recorded PCM telemetry data. Tape recorder electronics [1] introduced phase shifts in the recorded IRIG time code carriers. Physical placement (alignment) of the reproduce heads on the tape recorders would also introduce variable time biases from machine to machine. Difficulties in predicting system time delays, not only in the telemetry data but in the IRIG time distribution equipment resulted in the search for a more accurate and reliable means of correlating the same telemetry time tagged data recorded at multiple sites.

The initial investigation by the SAMTEC resulted in the design and implementation of a Time Correlation Generator (TCG) system. The TCG uses a one pulse per second (pps) strobe from the telemetry site local time code generator and then inserts a recognizable pattern into the postdetection recorded telemetry bit stream. Through post launch analysis of this data, the inserted pattern is correlated with the IRIG millisecond markers and a relative timing bias correction factor is calculated and applied to the inertial guidance data during post launch processing. Through the use of the TCG system SAMTEC analysts were able to measure inertial guidance internal timing instabilities which were not previously measured during missile flight. However, the TCG system had two basic limitations, the resolution after data processing was limited to plus or minus one bit time (about 3 microseconds for the prime missile system user) and the repetitive frequency of time correlation (once per second) introduced aliasing.

The ballistic missile user has specified new timing requirements to time tag all telemetry data referenced to the time it was transmitted from the missile. This requires the synchronization of all uprange telemetry sites to within 3 microseconds relative and all metric radar sites to within 10 microseconds relative of each other and the telemetry sites. This has resulted in the latest uprange WTR configuration for time synchronization and distribution. The user's timing requirement was satisfied through

two actions by SAMTEC. First, time tagging of the telemetry data and time synchronization between telemetry sites was accomplished through the design and implementation of a new SAMTEC development designated the Timing Insertion Unit (TIU) and secondly, the metric radar time correlation will be accomplished through the use of intersite time correlation technique using the radar Automatic Phasing System (APS).

#### Timing Insertion Unit

The time synchronization accuracy requirements necessitated the development of a new operational approach to the problem of accurate time tagging of missile events. These events were to be tagged with respect to the time of transmission rather than time of data receipt. This requires not only synchronization of time between telemetry sites but also an accurate knowledge of the missile location during flight. This latter requirement is solved through the use of inertial guidance position and velocity data in terms of  $x$ ,  $y$ ,  $z$  and  $\dot{x}$ ,  $\dot{y}$ ,  $\dot{z}$ , contained within the telemetered PCM data stream. But additional confirmation of the missile position is required for guidance analysis. Therefore, accurate metric radar data, correlatable to the telemetered PCM data, is also required. From these factors, timing support requirements were fixed to within 3 microseconds between telemetry sites and to within 10 microseconds between radar and telemetry sites. Resolution of the telemetered PCM data and inserted timing was fixed at one tenth of a microsecond.

The goals of the design require that all known sources of error such as telemetry propagation delay, receiving system delay, etc. be minimized. In addition this should provide the necessary information to accomplish a relative time correlation between telemetry sites. The TIU units, installed at each telemetry site, derive their time stability from cesium frequency standards traceable to the U.S. Naval Observatory (USNO) Coordinated Universal Time (UTC). The traceability to USNO/UTC is established through a SAMTEC Precise Time and Time Interval (PTTI) calibration program.

The basic operational concept of the approved TIU design recognizes the telemetered frame sync pattern of the PCM frame or subframe. After frame or subframe recognition it then waits for the leading edge of the first PCM bit following frame sync to occur and strobes binary coded decimal (BCD) time (in hours, minutes, seconds, milliseconds, microseconds and hundreds of nanoseconds) into a storage register. The time word is then strobed from the storage register into the PCM data stream at a known and predetermined data word location. The PCM/TIU data is then outputted in a serial format for recording and subsequent data processing.

A functional block diagram of the TIU application is shown in Figure 4. The TIU interface consists of a PCM bit synchronizer which reshapes the raw PCM telemetry data and generates a zero degree clock, a frame decommutator which provides frame sync recognition input, a time code generator for providing BCD timing input, a cesium frequency standard for providing a stable five (5) megahertz (MHz) input frequency to the time code generator, and associated power supplies and output driver circuits.

Since all inserted BCD timing from each TIU is referenced to the arrival of the same telemetry data bit, and the position and velocity information in the terms of  $x, y, z,$  and  $\dot{x}, \dot{y}, \dot{z}$  of the transmitting ballistic missile is well known; it becomes a routine processing computation to first, correct the inserted time tag to the time of data transmission and secondly, to determine relative time from one telemetry site to another. If required, correction of the inserted time at any site relative to any other site can be computed. Thus, through the application of the TIU and post launch processing of data preoperational telemetry site synchronization of time is not required. It is only necessary to have each supporting telemetry site provide overlapping telemetry coverage in order to effect an intersite time correlation of the post launch processed telemetry data.

Figures 5 and 6 show typical telemetered transit time corrected TIU measurements of on-board inertial guidance system clock instability with a peak-to-peak jitter of 40 microseconds. The two sets of data were recorded over the same flight time interval from two independent WTR telemetry acquisition sites with overlapping coverage. The precision and accuracy of the TIU is one part in  $10^7$ .

Metric radar timing correlation is accomplished using the automatic phasing system at uprange locations.

#### Radar Automatic Phasing System

The WTR metric radar systems utilize the APS to prevent "beacon stealing" or multiple radar returns, when two or more radars are tracking a single target. The radar phasing system designates the radar under test into a transmit time slot and maintains the radar transmitter in that time slot regardless of its target range; this prevents an overlapping of the radar returned signals. Figure 7 is a simplified block diagram of the APS used at the WTR. As shown, the radar pulse repetition frequency (PRF) of 160.0864 pulses per second is derived by division of a 5.24571328 MHz signal which is synthesized from a 5 MHz cesium frequency standard signal. The time of occurrence (TOC) of the first pulse of the radar 160.0864 PRF is controlled by a time code generator/ synchronizer

also driven by the cesium 5 MHz frequency reference. Thus, if all radar site cesium frequency standards are "on time" and all radars are assigned to the same transmit time slot, the transmit times of all radars will occur at the same time epoch.

If relative time correlation between two radar sites cesium frequency standards is required as illustrated in Figure 8, it is only necessary that each radar system range on the others transmit pulse. The relative range measurement difference now represents the relative time difference between the two site cesium frequency standards. To synchronize the two sites it is necessary to adjust one of the cesium frequency standards until both radar systems measure the same range. Time correlation using this method has a resolution accurate to within the measurement accuracy of the radar which is less than 50 feet, or approximately 50 nanoseconds in time, and assumes only that the two-way radar range transmission times are the same and that internal system time delays within the radars are known. Typical results of APS measurement are within plus or minus one microsecond as compared against a portable traveling clock. This clock also provides the traceability to USNO/UTC.

The method of time synchronization between radar and telemetry sites at the WTR has been greatly simplified since one of the cesium frequency standards located at the Pillar Point Air Force Station, California provides a common frequency reference to co-located telemetry and metric radar systems.

#### Backup Time Correlation Considerations

The use of the metric radar APS to achieve the 10 microsecond relative time correlation between metric radar sites and telemetry sites has been demonstrated. The APS availability for time correlation measurements cannot always be assured because of the higher priority operational system commitments. To circumvent this, SAMTEC is evaluating the use of other backup time correlation systems i.e., TV Line-10, Geostationary Operational Environmental Satellite (GOES), and other available systems.

The TV Line-10 relative time correlation application is jointly being evaluated between Camp Roberts U.S. Army Satellite Communications Station and the SAMTEC Precision Measurement Electronics Laboratory (PMEL) Vandenberg Air Force Base, California. Preliminary data shows better than one microsecond resolution when compared with the PMEL cesium frequency standard and LORAN-C. In addition, SAMTEC has obtained two GOES satellite timing receivers for evaluation.

A secondary benefit of either system is that it will provide SAMTEC performance analysts a means to trace the cesium frequency standards instability (drift) with USNO reference clocks. This capability provides a more effective method to evaluate cesium frequency standard performance and calibration intervals.

#### Conclusions

SAMTEC has demonstrated that through the use of the Timing Insertion Units and Automatic Phasing Systems, that relative intersite timing can be correlated and controlled to less than one microsecond for telemetry and metric radar sites. Although further improvements to the WTR terrestrial timing system are possible, it appears that until the on-board inertial guidance clock stability is improved to one part in  $10^9$ , the WTR terrestrial timing system will not be a limiting factor.

## REFERENCE

- 1 Pickett, R. B., Matthews, F. L., "Precise Timing Correlation in Telemetry Recording and Processing Systems" Proc. 5th Precise Time and Time Interval Planning Meeting Goddard Space Flight Center, Greenbelt, Md., December 1973. NASA Publication X814-74-225.



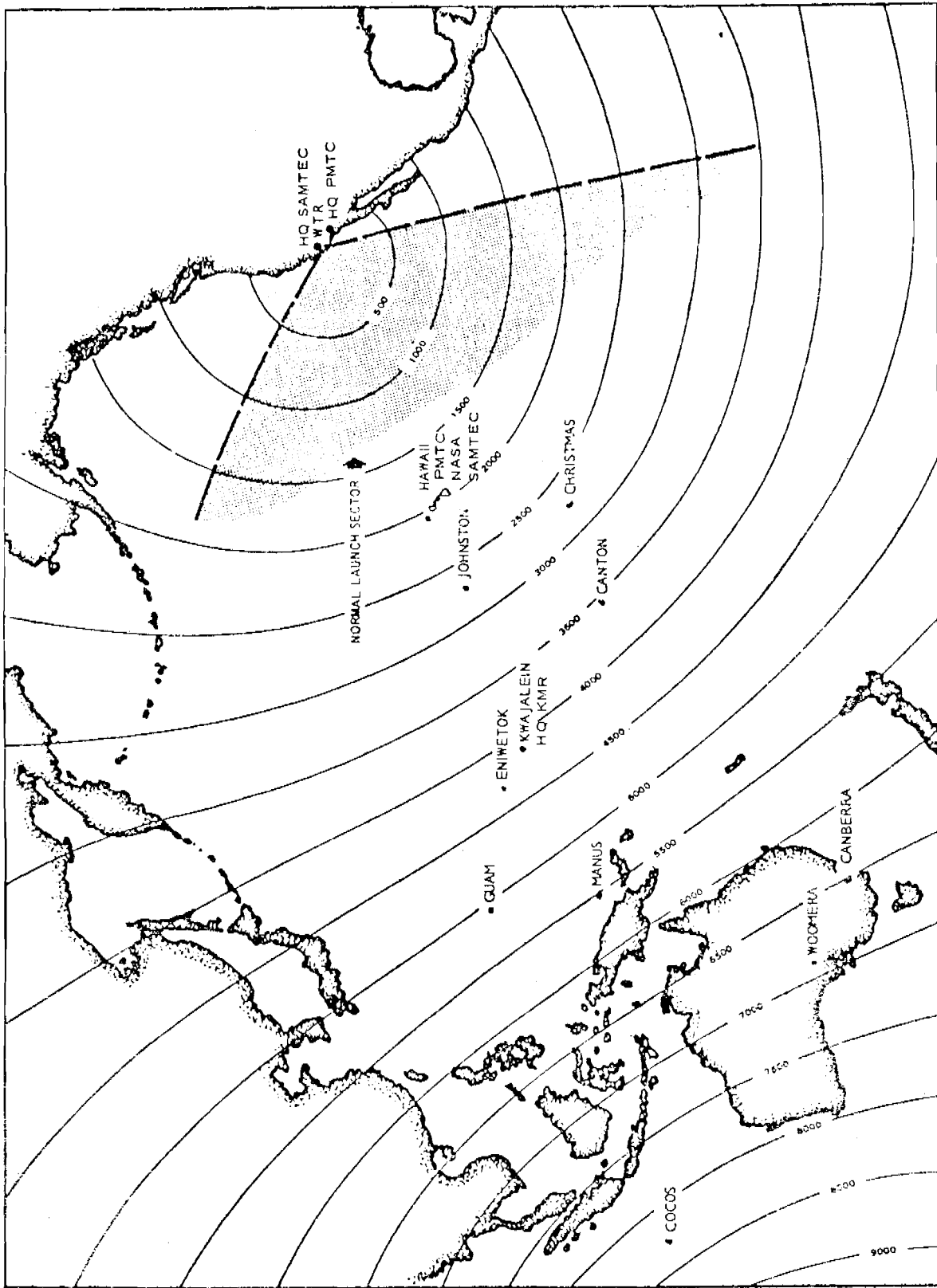

Fig 1 Western Test Range Sector

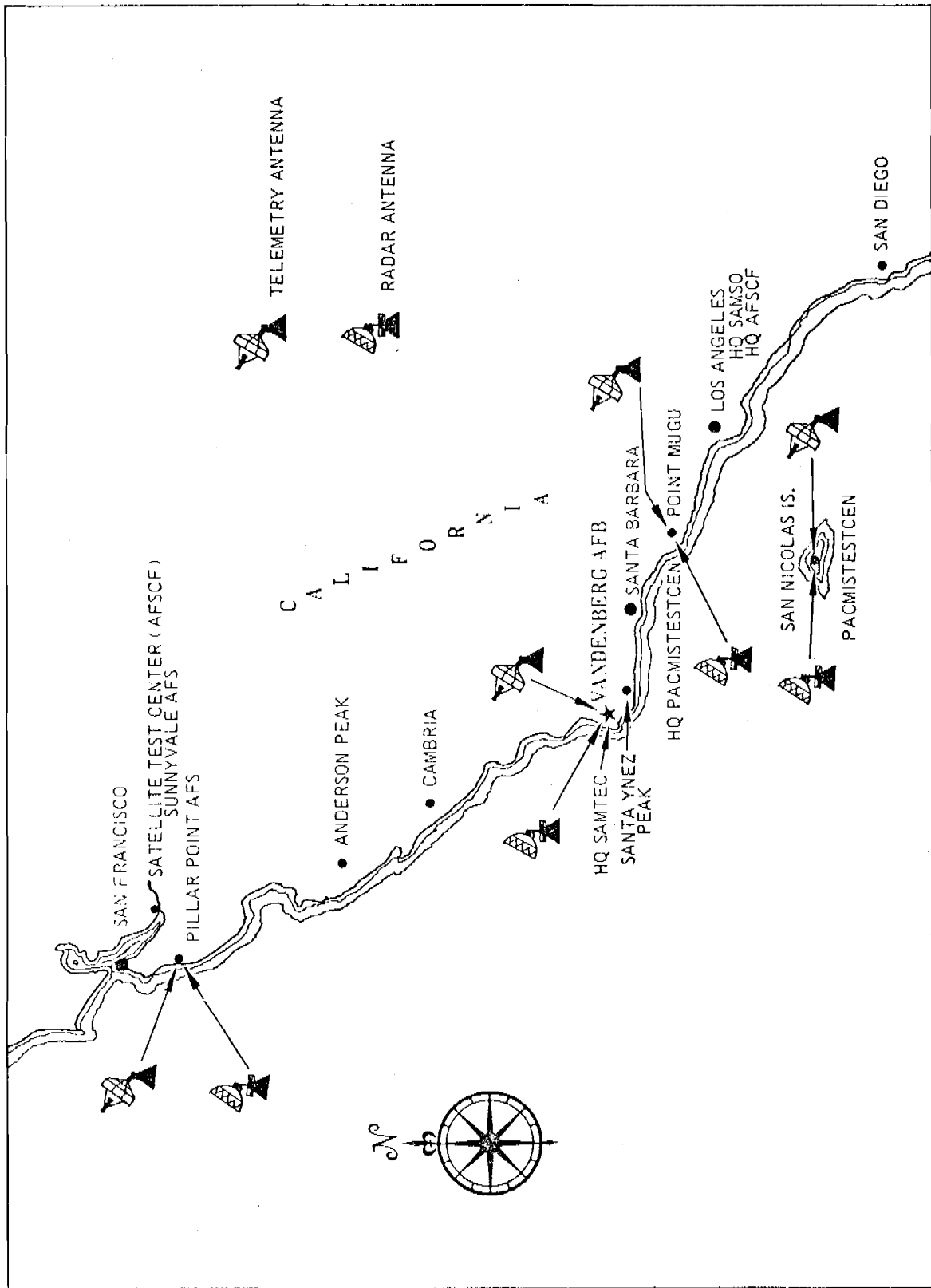

Fig 2 Western Test Range Uprange Facilities

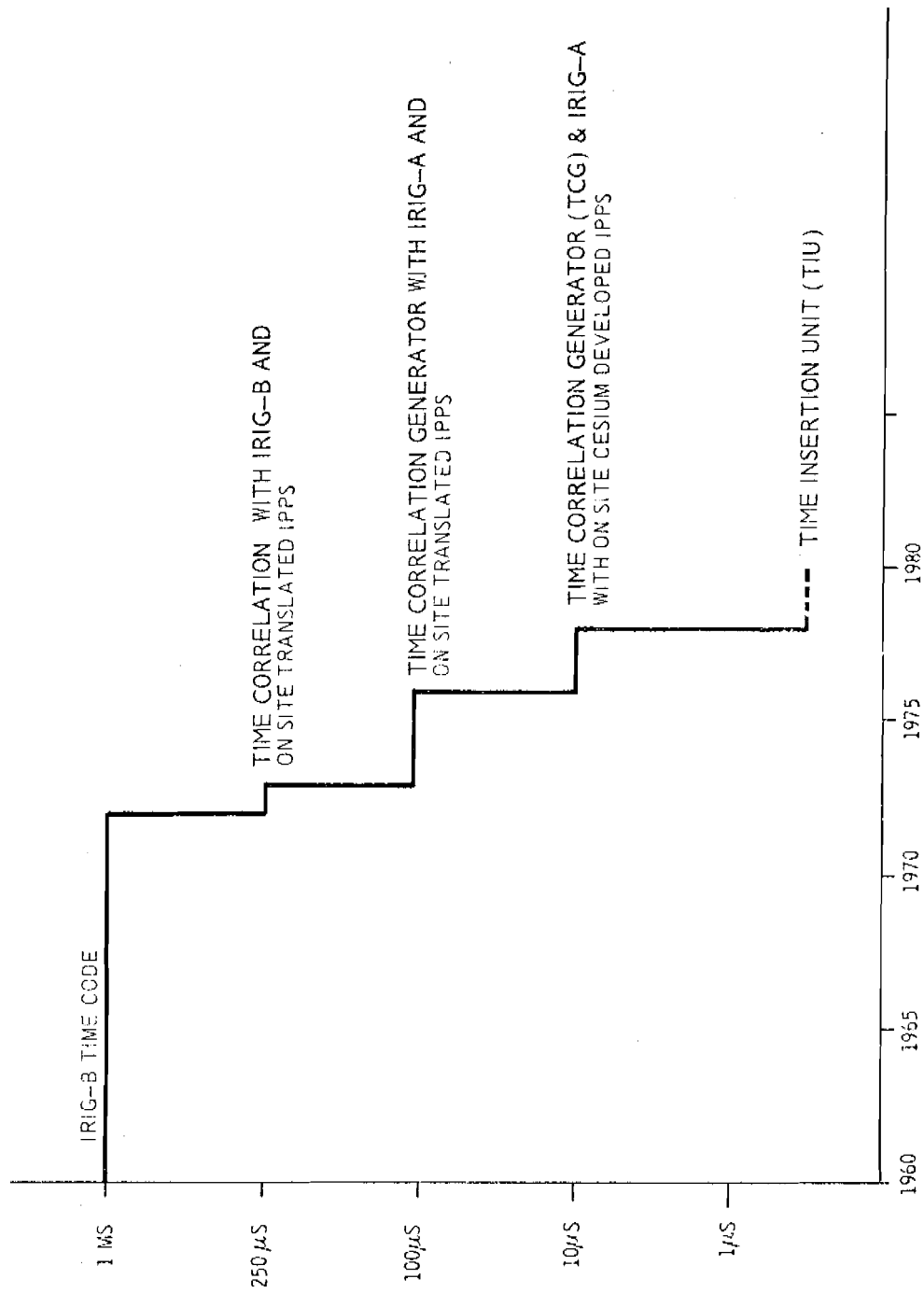

Fig 3 Histogram of Telemetry Data Time Accuracy Improvement

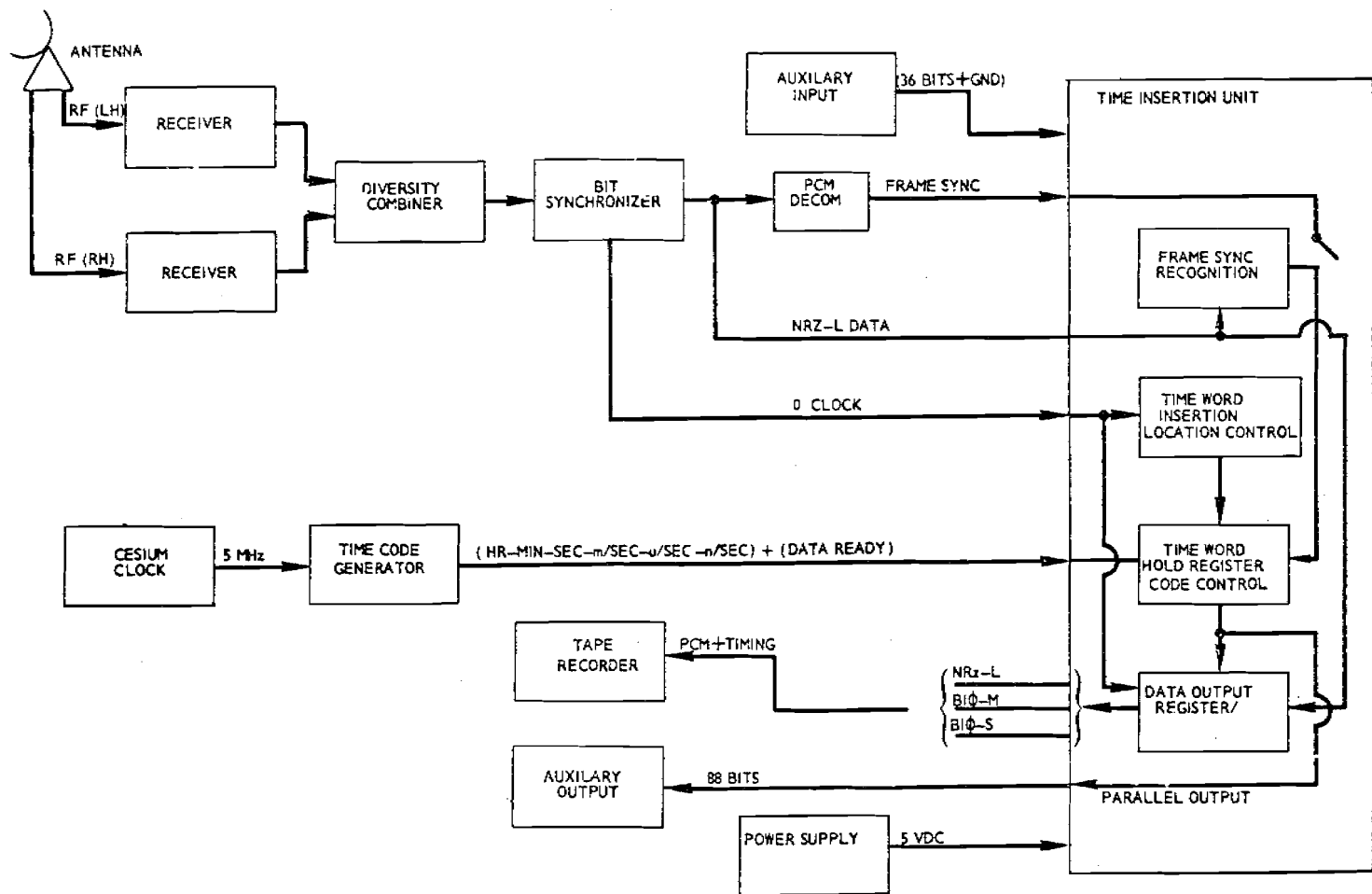
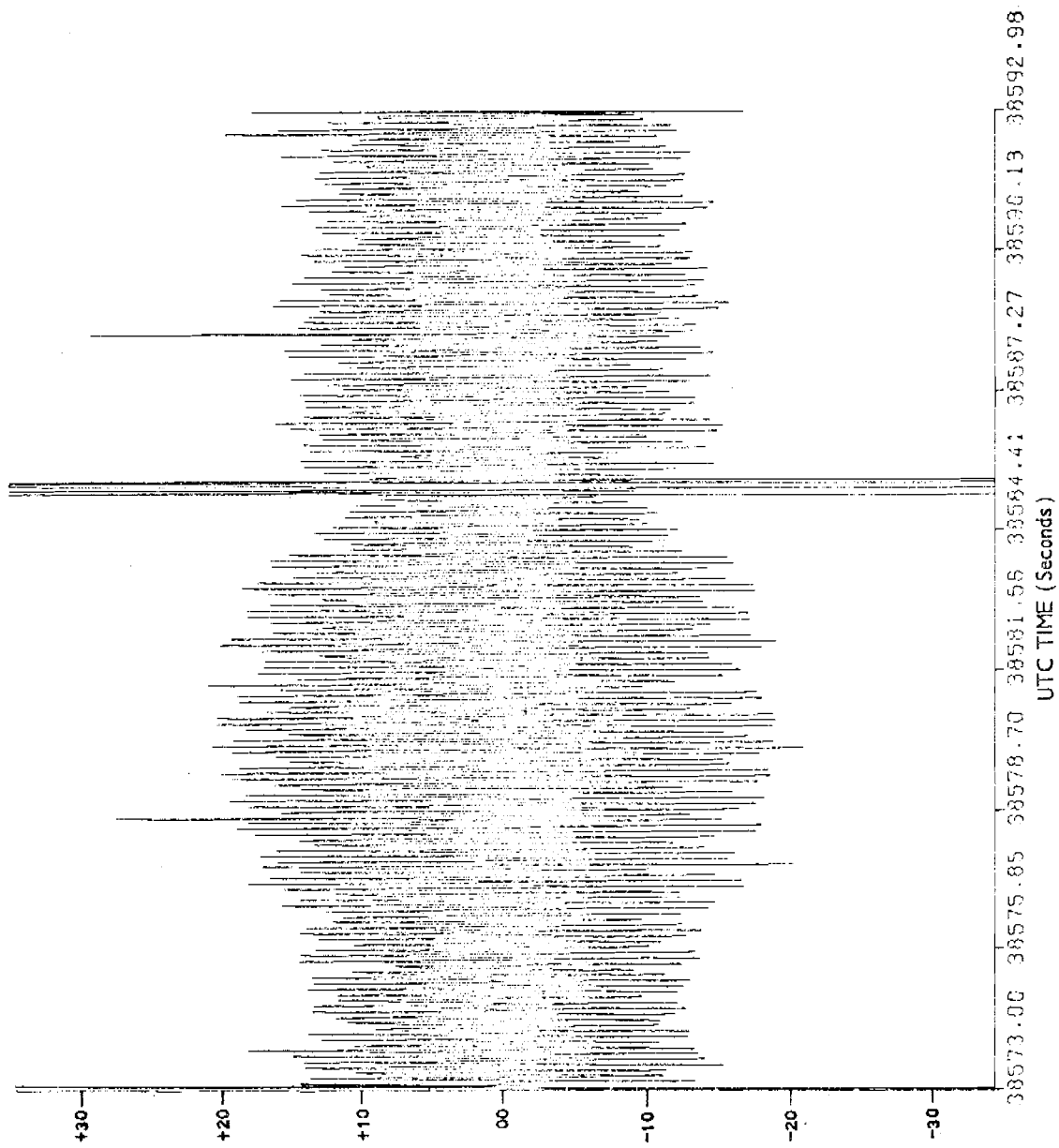

Fig 4 Functional Block Diagram of Time Insertion Unit Application



PILLAR POINT TIU  
 INDICATED MISSILE CLOCK  
 STABILITY ( Seconds)

FIG 5 PILLAR POINT\*

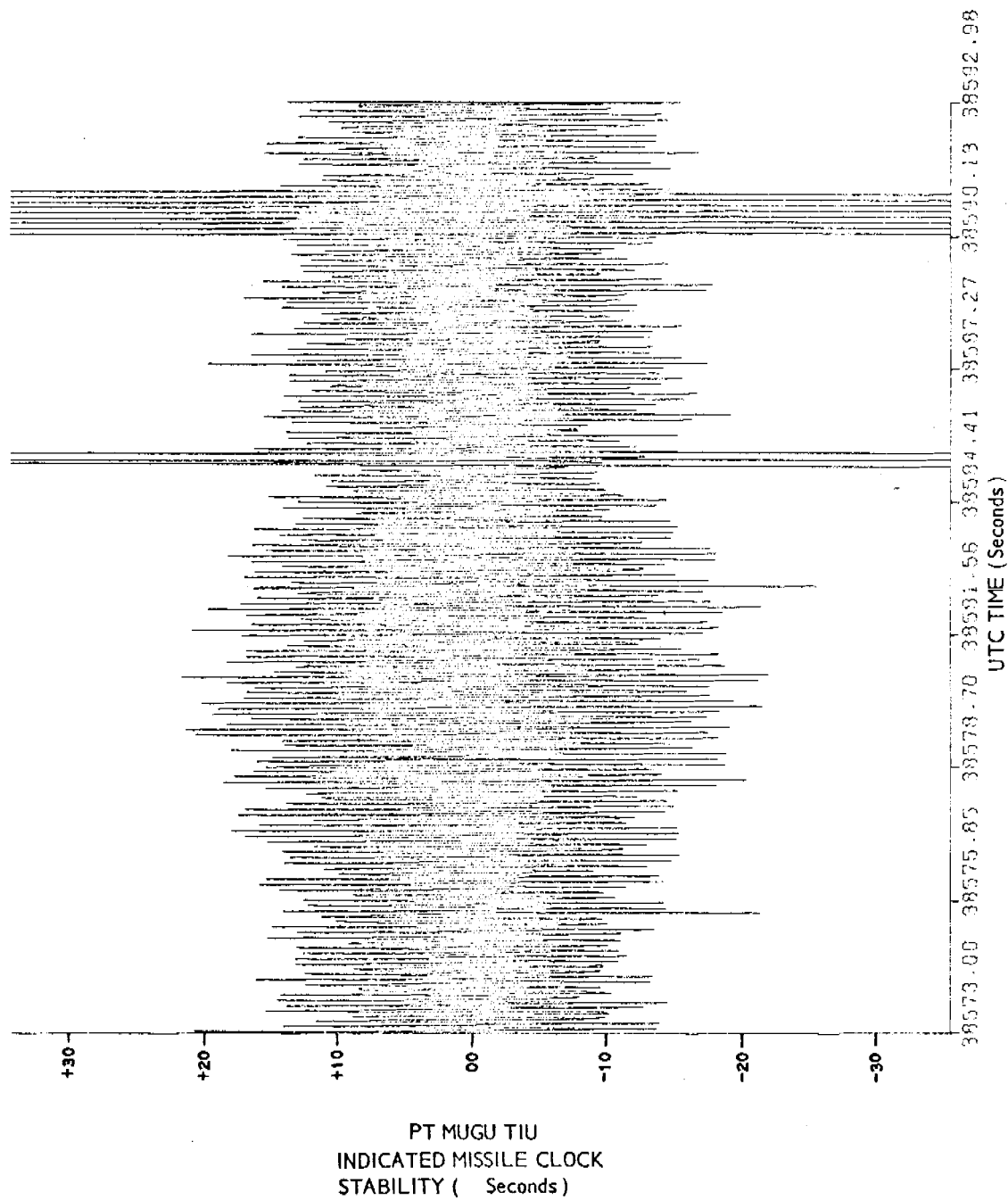

FIG 6 POINT MUGU\*

\* Includes acquisition site hardware anomalies.

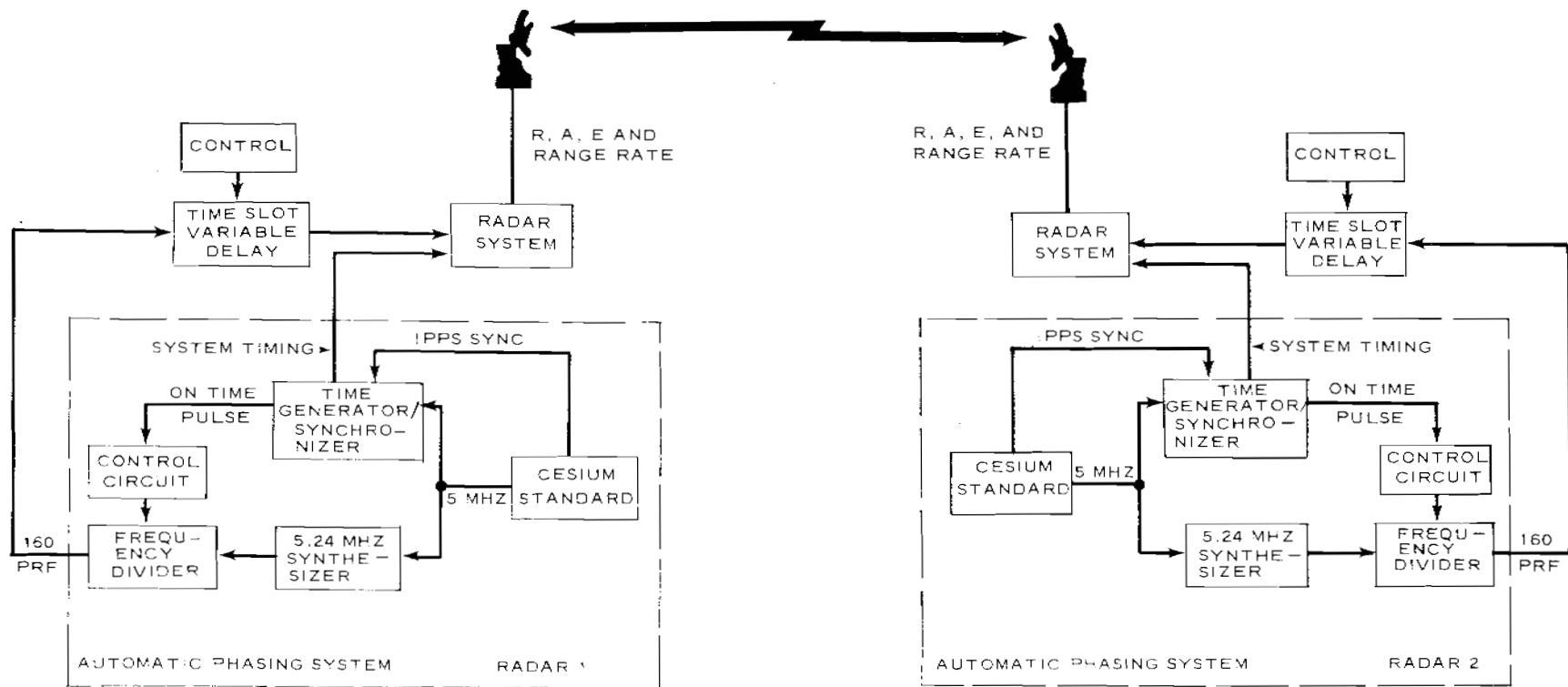

Fig 7 Operational APS block diagram of typical time correlation measurement.

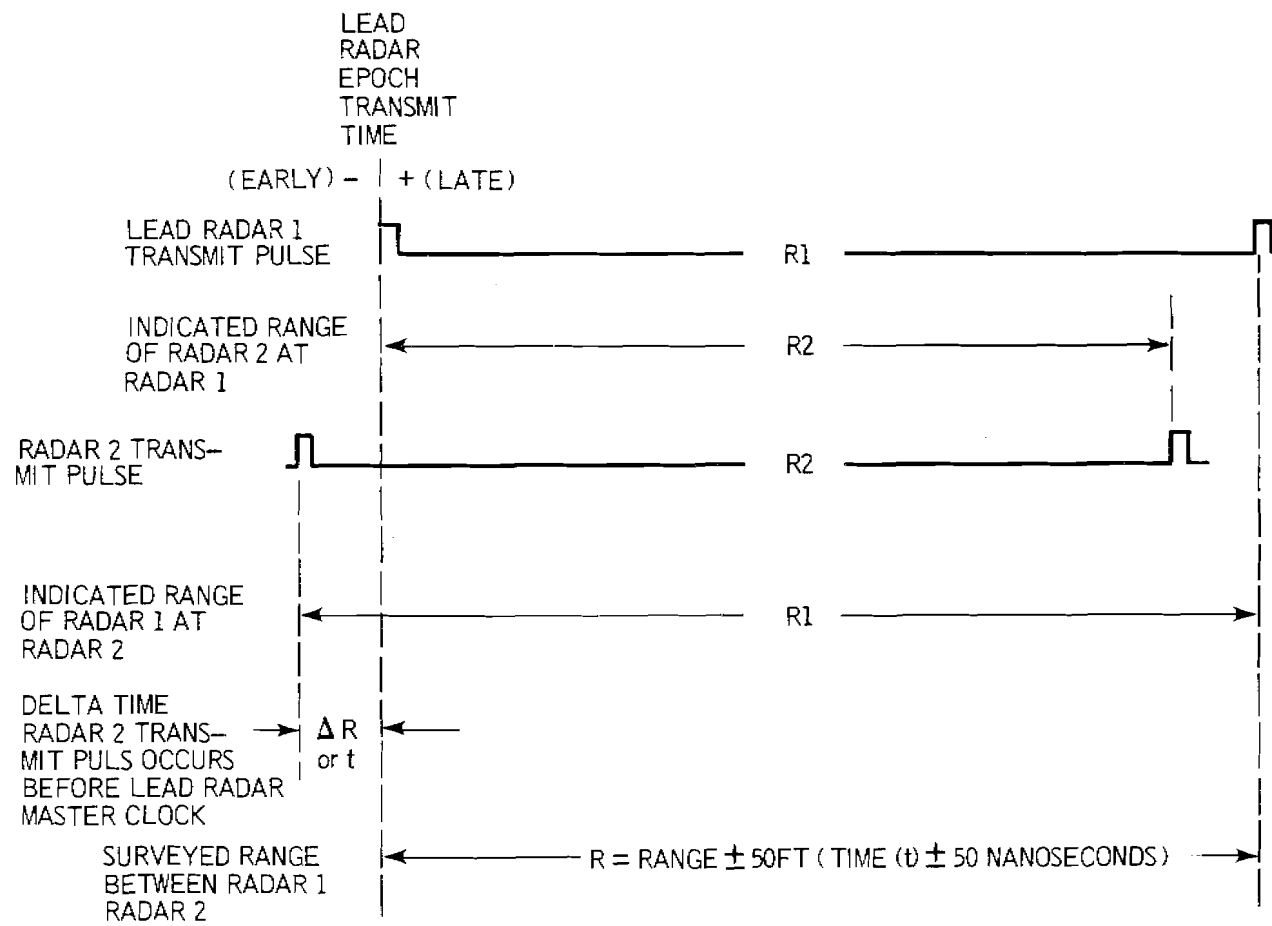

Fig 8 Time Correlation between two radar sites.