

UTILIZATION OF FSK COMMUNICATIONS FOR TIME

Robert R. Stone, Jr.

Thomas H. Gattis

Naval Research Laboratory

Theodore N. Lieberman

Naval Electronic Systems Command

The original purpose of this paper was to present off-the-air data on the recovery of a time stream transmitted by the VLF station NBA at Summitt, Canal Zone. Due to unforeseen difficulties in the procurement of some critical components required in the antenna portion of the system, the commencement date for transmission was delayed until January 1973. No actual data has been received from the station at this time; however, the system has been simulated in the laboratory.

This presentation will be divided into two parts:

- The first part discusses the method of time control employed at NBA for time-signal transmission. It also describes methods of extracting a "recovered clock" at the receiver and presents data derived in an experiment at the Naval Research Laboratory (NRL) and from a signal received from NLK/NPG, located at Oso, Washington.
- The second part of the presentation discusses requirements for adapting PTTI control to Naval Communications Systems. It describes a method for reducing the time required for synchronization or identification of messages and the fallout from the communication system to passive timekeeping users.

FSK COMMUNICATIONS FOR TIME

Figure 1 shows the stations, locations, assigned frequency, and nominal radiated power of the Naval VLF high-powered transmitting stations. At the present time, all of these transmissions are frequency/phase stabilized and are monitored by the Naval Observatory. The local station clocks are derived from cesium-beam oscillators which are maintained in frequency to within several parts in 10^{11} . These stations operate in an FSK mode with the lower carrier on the assigned frequency and the upper carrier offset by 50 cycles. It operates at 50 baud in 7.0 teletype code. In all stations except Northwest Cape Australia, only the on-frequency carrier is phase controlled. The offset frequency phase will vary to compensate for variations in the bit-stream timing. At Northwest Cape the bit stream is retimed.

In order to realize the full capabilities of the VLF system for PTTI purposes, it is necessary to control all time aspects of the signal. A block diagram of the NBA control system

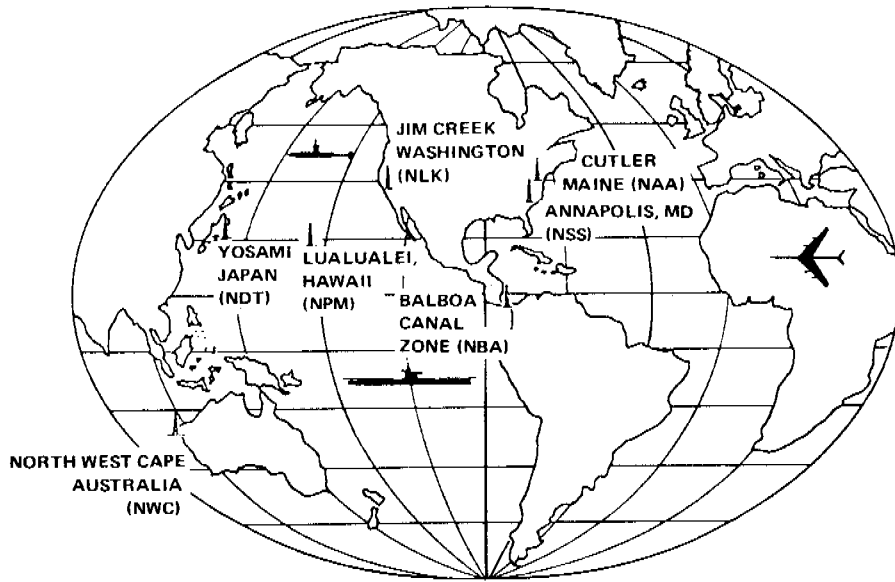

STATION	LOCATION	FREQUENCY (kHz)	NOMINAL RADIATED POWER (kw)
NAA	CUTLER, MAINE 44°38' 9N, 67°16' 9W	17.80	1,000
NBA	BALBOA, CANAL ZONE 09°03' N 79°39' W	24.00	150
NDT	YOSAMI, JAPAN 34°58' N 137°01' E	17.40	50
NLK	JIM CREEK, WASHINGTON 48°12' 1N, 121°55' 0W	18.60	250
NPM	LUALUALEI, HAWAII 21°25' -N 158°09' -W	23.40	140
NSS	ANNAPOLIS, MD. 38°59' -N 77°27' -W	21.40	85
NWC	NORTH WEST CAPE, AUSTRALIA 21°49' 0S, 114°09' 8E	22.30	1,000

Figure 1. The Naval VLF high-powered transmitting stations.

is shown in Figure 2. This system differs significantly from previous control systems since it will provide for not only phase control of both carriers but also the time of transition. All of the driving signals and time references are provided by a cesium-beam clock system which is coordinated in time by the Naval Observatory. The input keying information is stored and retimed in the storage buffer unit. The output from this unit keys the coherent FSK keyer, which provides the signal for driving the transmitter. The output of the transmitter is monitored at the antenna. Both of the carrier frequencies are tracked in the comparator. The positive going-zero crossings of these tracked frequencies are detected and divided down to produce 20-millisecond time streams. These time streams are then compared with a 20-millisecond time-stream reference from the clock. The error signal between the clock stream and the divided-down on-frequency carrier is used to phase control all of the signals required by the storage buffer and the coherent FSK keyer. The error signal produced from the comparison of the clock 20-millisecond stream and the divided-down off-frequency carrier is used to control the differential phase between the on-frequency carrier and the off-frequency carrier. In this manner, an output signal format is produced as shown in Figure 3. The positive going-zero crossings of the carriers are held on time. Selection of a particular cycle in each 20-millisecond segment is accomplished in the digital division. The divided signal marks the point of phase coincidence between the two carriers. This point can then be adjusted in calibration to occur at any selected point in the FSK transition. The center point on a transition was chosen to provide an easily identifiable spot for systems employing discriminators. Once set and calibrated, the control points will hold to within ± 200 nanoseconds of the reference clock.

An experiment was conducted using the block diagram shown in Figure 4 to determine the effects of noise on the recovered clock and to make a comparison between a discriminator demodulator and a coherent demodulator. A communication receiver, BRR-3, was employed. In normal noncoherent operation, the discriminator demodulator is used, but for coherent demodulation a special demodulator unit was developed which demodulates the IF output frequencies and phase locks the local oscillator in the BRR-3 receiver to a stable reference source. The recovered clock was compared in a phase meter with the local clock and displayed on a recorder. A simulated signal attenuated to the normal expected input level was fed into the receiver and a VLF antenna was also connected so that noise conditions would be nearly the same as those encountered when receiving an actual transmission.

Figure 5 shows the results of these tests at three levels of input signal with noise level essentially the same in all cases. The signal level in the upper chart is equivalent to that normally received in Washington from NBA. Note that the width of the line in this case is about 50 microseconds. If the signal is further averaged, ten microseconds can easily be obtained. This is sufficient to identify the cycle of the tracked on-frequency carrier. Even though epoch timing control has not been installed at the other VLF transmitters, the stability of the input keying is sufficient to produce periods of 15 to 20 minutes of stable

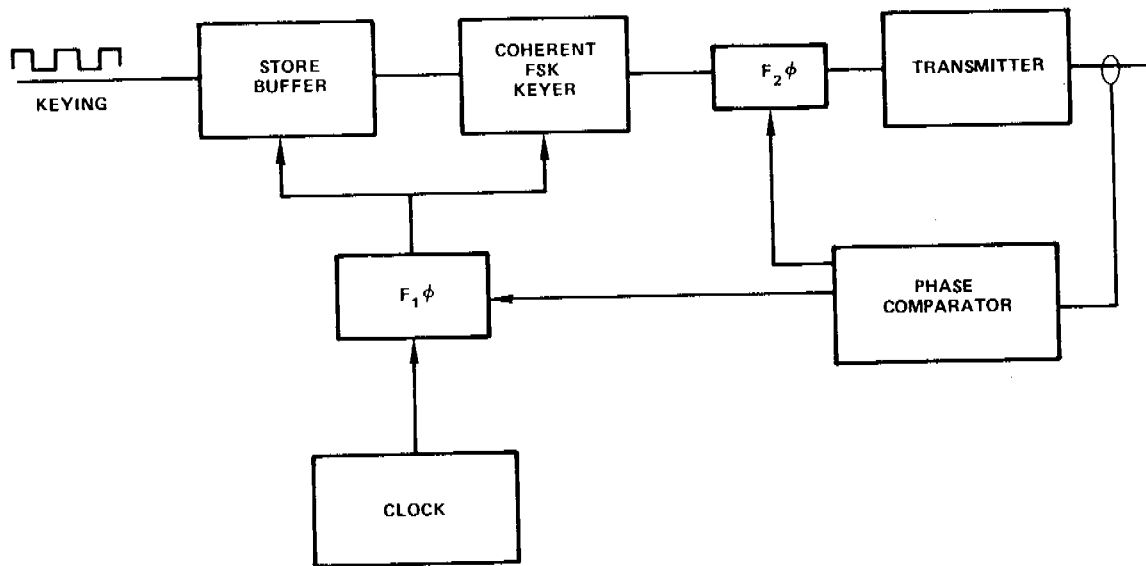

Figure 2. VLF time.

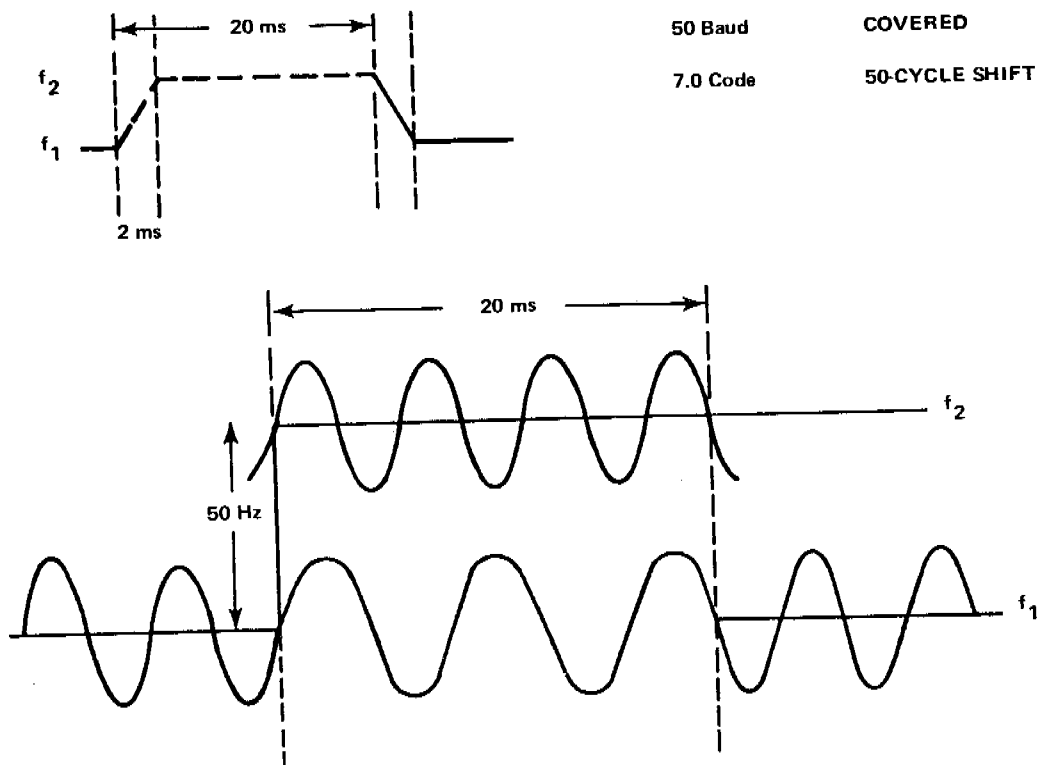

Figure 3. VLF/FSK signal format.

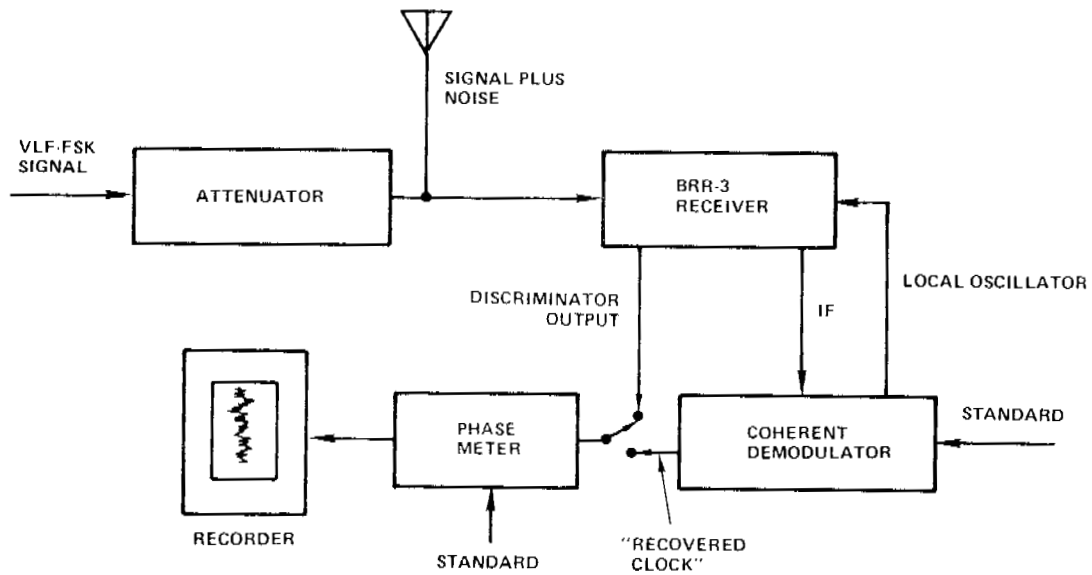

Figure 4. Measurement of VLF/FSK coherent/noncoherent timing transitions.

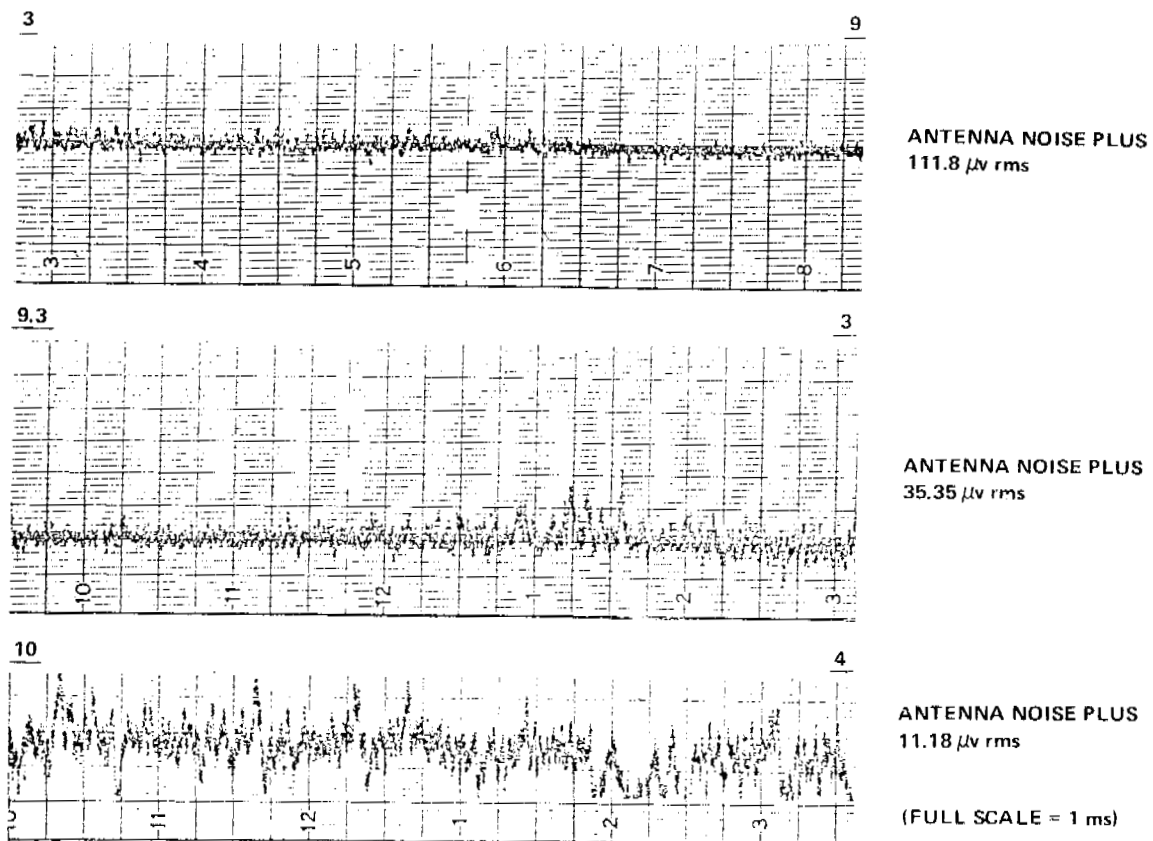

Figure 5. Recovered clock from VLF/FSK signal.

timing. Figure 6 shows data taken from the signal received from NPG/NLK at 18.6 kHz. The left portion of the graph shows the operation with the receiver's discriminator and the right portion of the graph shows the operation with the coherent demodulator. The abrupt shifts in the line were caused by changes in the phase of the offset frequency. The straight portions of the line indicate the stability of the recovered clock. These preliminary data indicate that the system will operate well for timekeeping purposes.

NBA is expected to be on the air in January, and at that time data should be obtained that will permit a more complete evaluation of the system.

PRECISION TIME AND TIME INTERVAL (PTTI) IN NAVAL COMMUNICATIONS

As a result of the application of new technology, the Naval Communications System is rapidly evolving into a high-speed digital network consisting of fixed, mobile, and itinerate users. Such a system portends multiplexing hierarchies based upon command levels, priorities, geographical locations, and so on. A fundamental limiting factor in such a system is network timing and synchronization. Basic to the success of such a system is the ability to define and discipline time interval and time-of-event.

The PTTI program addresses itself to the definition and coordination of precision time and time interval. A communication system may take the form shown in Figure 7. Here several communication nodes or functions are involved. These nodes may originate or transfer communication information and they may operate in a one-way or two-way mode. Furthermore, they may consist of synchronous or asynchronous systems. A rather complex situation is created wherein the interleaving of synchronous, asynchronous, high-speed, and low-speed data streams may be required. In addition, the time required for processing within the nodes, transit between the nodes, and variations in these time lengths must be considered. Unless a discipline is imposed on the bit, frame, link, and network synchronization or an intolerably large buffer is included, the system will be subject to a high error rate. The implementation of the PTTI concept will provide each node with a knowledge of time coordinated from a single point, with an error which is small compared to the length of the bit. It will also provide a means for the precision control of the timing aspects of the station, which will result in an ability to precisely control bit lengths and the position in time of code streams.

A PTTI-coordinated communication node may appear as shown in Figure 8. Bit timing will be coordinated at each node so that as each bit is transmitted by the node, the bit's leading edge will be synchronized to coordinated time. Frame, link, and network timing should be referenced to coordinated time and predesignated according to operational constraints. Predesignation may be made by preassignment, preamble, program, hierarchical level, or operational decision. In any event, the receiving node should be cognizant of the predesignated times so that code-stream presynchronization may be accomplished relative to the station PTTI-coordinated clock.

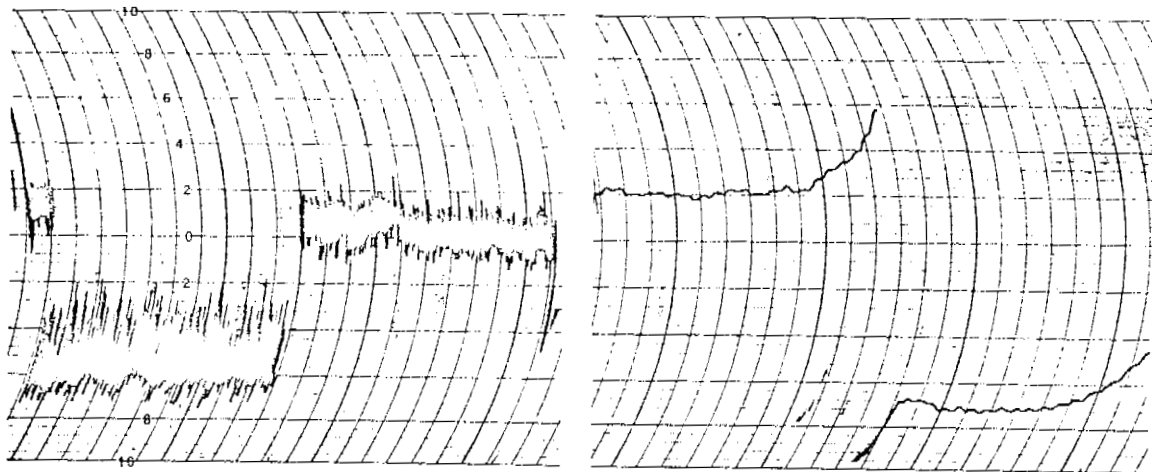

DISCRIMINATOR
NON COHERENT
RECEIVED SIGNAL

DISCRIMINATOR
RECOVERED CLOCK
COHERENT SIGNAL

SCALE 1" = 5 MIN
FULL SCALE = 10 MS

Figure 6. Data summary sheet.

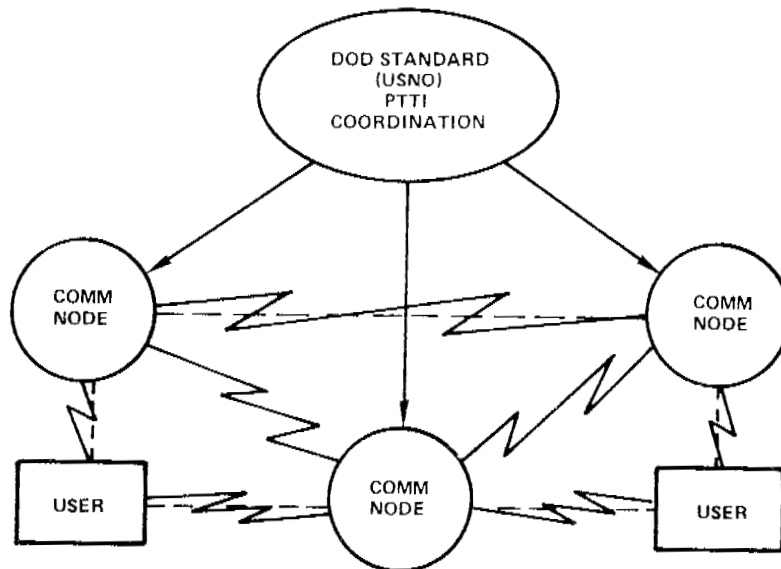

Figure 7. Communications network concept.

PTTI implies that at each communication juncture or node, a time reference be maintained which is sufficiently stable in its long-term average to provide a time of event in which the error is small relative to the length of the bit and to provide this time of event even after considerable periods of no communication. The stability and synchronization of the local reference clock are basic requirements. PTTI assumes the utilization of any available method for synchronization, including both active and passive systems (Figure 9). Any transmission containing a characteristic which can be identified in time can be utilized for time transfer and the subsequent synchronization of a local clock. Two-way systems have a capability for the correction of propagation delays. The time-transfer accuracy will be a function of the system precision. The accuracy of one-way systems will naturally be dependent upon not only the precision of the system but the predictability of the transmission delay as well. At the present time, the most accurate operational method of time transfer over long distances is through the DSCS Satellite System, which can provide coordinated time anywhere in the world to 1/10th of a microsecond. Other systems, such as Loran C, VLF, UHF, or HF, are dependent upon the proximity of the user to the transmitter. The VLF system, for instance, can provide coordinated time on a worldwide basis to within a few microseconds. It is expected that all major areas, such as short-communications stations, shipyards, or any major rendezvous point for ships, would maintain high-precision time and would have the capability for the transfer of this time over short distances to mobile units such as ships or aircraft. It must also be recognized that the systems which are utilized by the communication nodes have a capability for time synchronization (see Figure 8). Extraction of this information can be accomplished without interfering with the normal communication aspects. The ability to keep time and to control time interval is dependent upon the stability and drift rate of the reference oscillators. Two basic modes of operation are envisioned by the PTTI program; namely, one which utilizes a nearly invariant standard, such as the cesium molecular-beam device, and one which utilizes standards which have drift rates and which require updating, such as crystal oscillators or rubidium standards. The basic difference lies in the fact that the frequency or time interval which is produced from a cesium molecular-beam device is based upon the statistical average of the actions of a natural phenomena which essentially remains invariant. The time interval in this case is known within one part in 10^{11} and can be relied upon without reference to other standards. The time-error accumulation in such a system also varies in a straight-line fashion and can be easily predicted over long periods of time. Crystal oscillators have inherent in their mechanical nature, drift rates which are affected by environmental changes. The required stability of an oscillator used for PTTI purposes will be dependent not only upon its inherent drift rate but also on the frequency at which it can be recalibrated.

Figure 10 shows typical frequency drifts of various frequency/time references. Figure 11 indicates the accumulated time error which would result from these drifts. It would be expected in a major communication node, such as a shore communication station, that a cesium molecular-beam reference standard would be utilized as the PTTI source and a

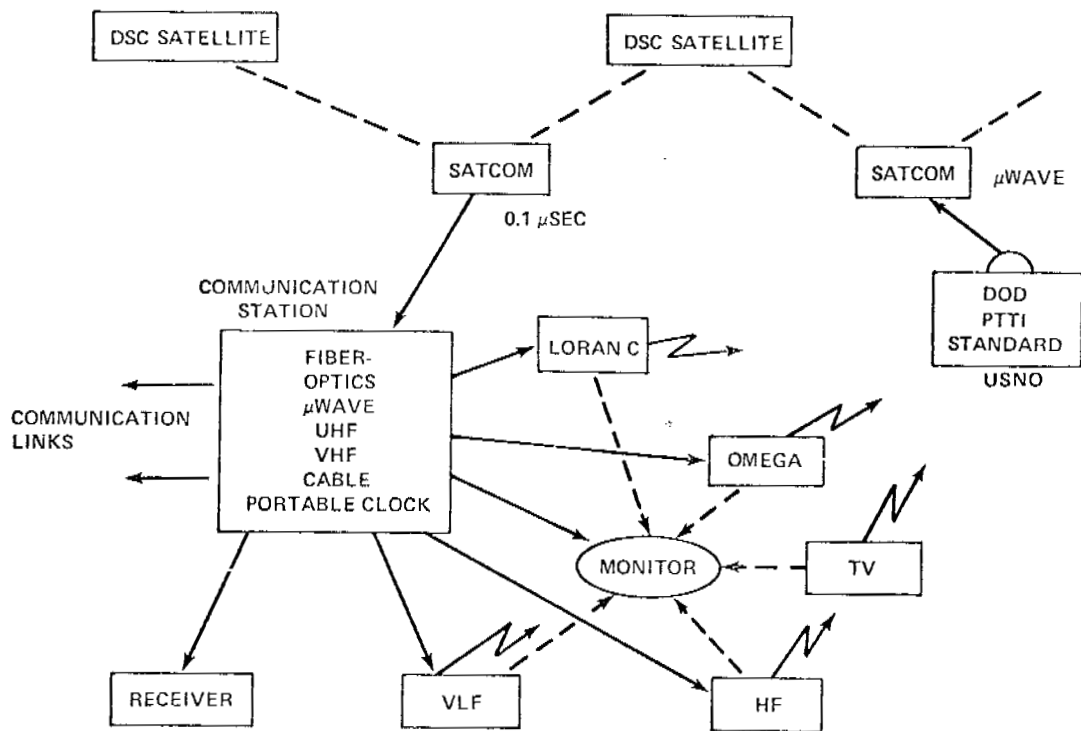

Figure 8. PTTI communication coordination.

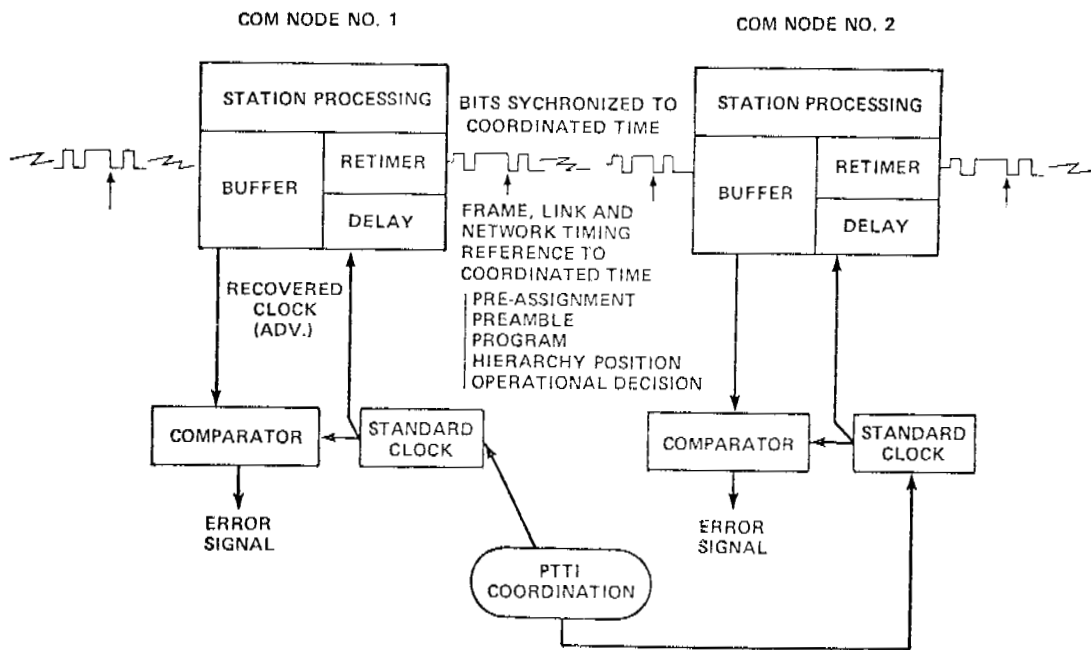

Figure 9. PTTI dissemination.

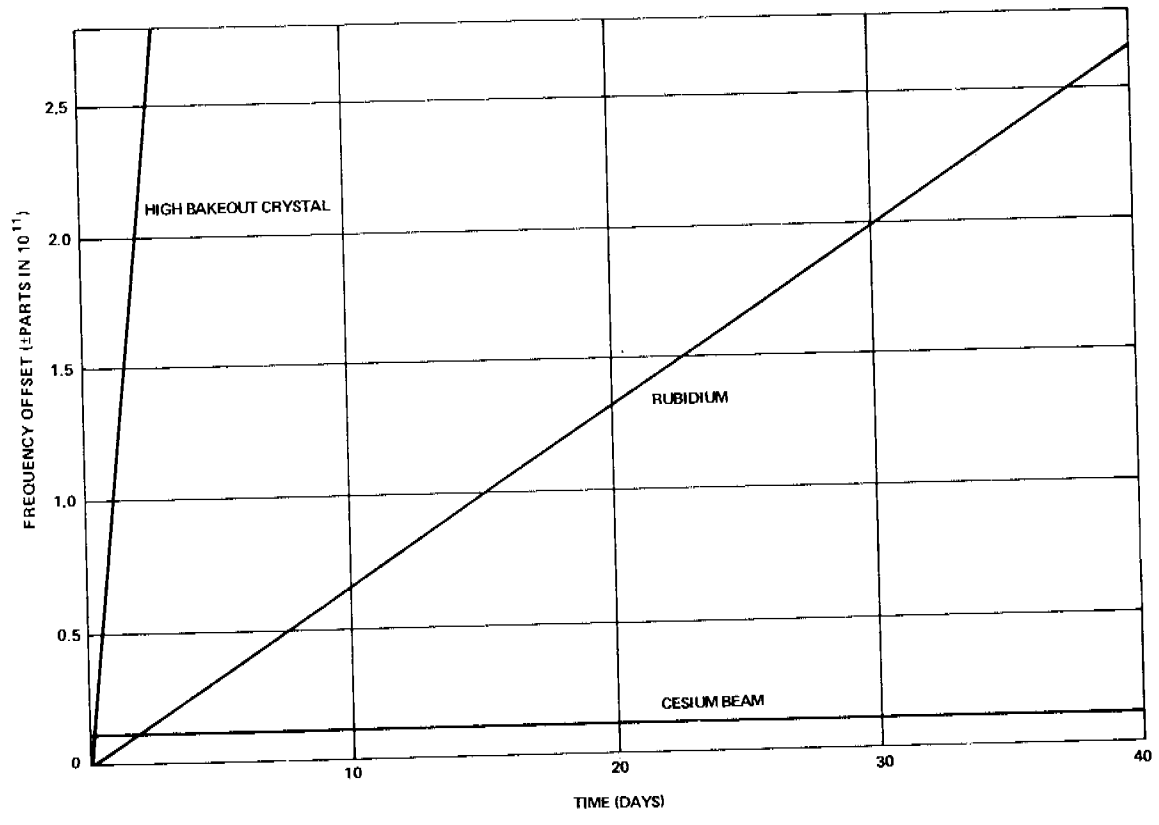

Figure 10. Probable maximum frequency offset without correction.

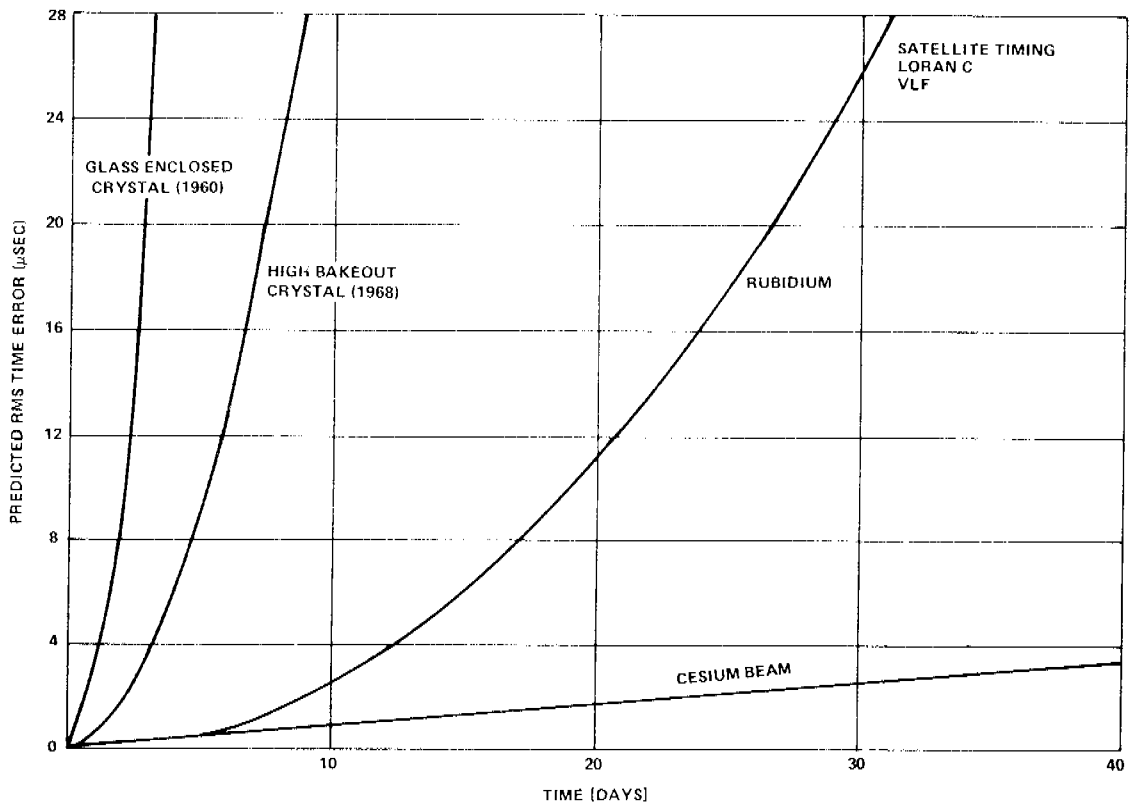

Figure 11. Probable maximum time error without correction.

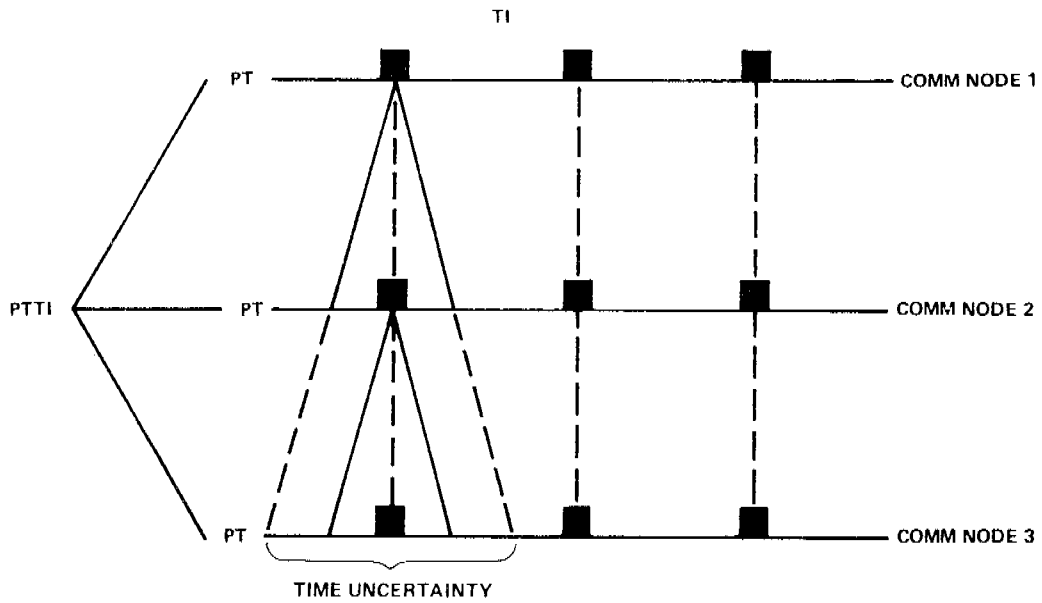

Figure 12. Precision retiming.

distribution made throughout the station. Discipline time/frequency oscillators would be utilized at user points. Synchronization of time kept by the standard clock could be accomplished by the most accurate or the optimum available method. Many COMSTAs have direct access to DSCS terminals. In the case of mobile units, means should be provided for direct synchronization with a major node (at the beginning of the mission).

One of the problems which exists in PTTI discipline of communication systems is that of delays arising from communication paths, instrument errors, or asynchronous systems. The solution to this problem lies in the ability to identify a predesignated time. Original broadcasts can be synchronized to start in a designated time relative to the standard clock. When a transmission is retransmitted after reception by a second communication node, its beginning must be delayed in sufficient time to account for any delays which occurred in the first transmission. One solution would be to normalize transmissions so that they would begin only at predesignated points, for instance, at each second. Another solution would be to designate the transmission start in accordance with the position of the node in the hierarchy. Since the transmission modes and patterns are known by the receivers, the precise beginning of message transmission from any given station would be officially designated. Either of these methods allows the station to presynchronize for any prescribed transmission. Network timing and synchronization can be made inherent in such a system, and the total delay involved in the transmission of a particular message could be reduced to the optimum. Time required for synchronization, resynchronization, or synchronization during jamming periods would be greatly reduced or eliminated. The advantage of retiming can be readily seen from Figure 6. The error introduced in the transmission path would be virtually eliminated when retransmitted from the following node.

In practice, the PTTI system will provide to the communication system a stable base for time-interval control and a coordinated reference for time-of-event control. It will utilize, where possible, characteristics of the communication links to maintain or verify the coordinated time. Under this system, a digital transmission would operate with all of its time-frequency aspects controlled relative to real time. The beginning of the code sequences would be designated by the operational constraints and would be subject to operational control. Such a method of operation permits the transfer of time to the nearest time increment through the communication, without interference. It also allows users who need only the time information the ability to extract it without the necessity of extracting communication information. Under this system many of the communication links would be automatic-position-location points which could be readily utilized by a tactical situation to determine propagation distances or position location.