

PRECISION TIMEKEEPING USING A SMALL PASSIVE HYDROGEN MASER*

F. L. Walls and D. A. Howe
Frequency and Time Standards Group
National Bureau of Standards
Boulder, CO 80303

ABSTRACT

The timekeeping ability of a prototype small passive hydrogen maser developed at NBS was recently compared to UTC(NBS) based on 10 cesium frequency standards including a large primary standard, NBS-4. The frequency of the passive maser was monitored as a function of source pressure, cavity temperature, microwave power, modulation width, and magnetic field. Based on these measurements one would expect a frequency stability of better than 6×10^{-15} over many days, implying a timekeeping ability of order 0.5 ns/day. Measurements vs. UTC(NBS) indicate a joint timekeeping stability of order 1.2 ns/day. In order to obtain a better estimate of the maser performance, simultaneous time measurements were made between NBS-4, UTC(6600), and the small passive maser. UTC(6600) is a time scale composed of nine commercial cesium standards. The estimates for the time stability of each were:

Small passive maser	0.99 ± 0.4 ns/day
NBS-4	0.74 ± 0.3 ns/day
UTC(6600)	0.74 ± 0.3 ns/day

Peak to peak time variations of the small passive maser vs UTC(6600) was 10 ns for the full 32 days if the average rate and drift are taken into account.

The frequency stability of the small passive maser vs UTC(NBS) was $\sigma_y(\tau) = 1.1 \times 10^{-14}$ for $\tau = 1$ to 8 days based on 32 consecutive days of data.

*Contribution of the National Bureau of Standards; not subject to copyright in the United States.

INTRODUCTION

The NBS passive hydrogen maser program has been directed toward the achievement of exceptional long-term frequency stability in order to provide a state-of-the-art frequency reference and basis for improvements in the stability of UTC(NBS), our official time scale. Two major advances have been made. The first demonstrated virtually unequalled frequency stability from 1 to 4 days using a passive full-sized hydrogen maser cavity design [1,2]. The second milestone, which is described in detail here, demonstrates that similar performance can be attained in a more rugged passive design that is about a factor of 5 smaller in size, weight, and cost than any previous design. Such a design is eminently suitable for use in precision time scales as well as space and field use.

SMALL PASSIVE MASER

Many of the features of the small passive maser were described earlier. Briefly, the passive maser allows for lower cavity

Q's, which permits different approaches to the cavity design (see Fig. 1). The type used here ultimately leads to a smaller cavity package [3]. Other small cavity designs have been proposed [4,5,6]. The cavity is a conventional TE_{011} mode with the addition of low loss alumina dielectric material on the inside of the electrical wall. The cavity design is a right circular cylinder with a bore down the central axis. The ends of the bore are capped with the same alumina dielectric material. The closed central bore then is the hydrogen storage volume. It is therefore possible to achieve good filling factor with this geometry, since the instantaneous rf magnetic field reverses sign in the dielectric and not in the open bore, which has the volume of hydrogen being interrogated. This geometry also has the benefit of good symmetry about all axes of the rf magnetic field in the storage volume (see Fig. 2).

Most masers use a conventional TE_{011} mode microwave cavity with a diameter of about 21 cm and length of about 50 cm. The lumped constant equivalent circuit for such a cavity consists of an inductance L in series with a capacitance C in series with a resistance R. The insertion of the low-loss dielectric affects the propagation constant ϵ thus increasing C and decreasing the frequency of the cavity. The overall dimension of the cavity can then be reduced to compensate for the effect of the dielectric. Symmetry, dielectric constant, overall dimension, and filling factor are then considered in order to achieve an optimum geometry. The effect of the frequency of the TE_{011} mode is taken into account at this stage. The dielectric loading of the cavity affects the electric field. The rf magnetic field (which excites the atoms) is pinned to the defined orientation of the electric fields within the cavity. It is possible to choose a cavity open diameter so that the oscillating axial H field does not reverse sign within this volume. Consequently, the inside bore can substitute for the

storage bulb used in a conventional maser with little compromise in the filling factor (see Fig. 3) [3]. A picture of the completed small maser cavity and shield assembly is shown in Fig. 4.

MEASUREMENTS OF PERFORMANCE

Identical designs were used for two small passive hydrogen masers (H3 and H4) which have the same linewidths (about 1Hz) and the same S/N ratios. Other clocks used in the comparisons are the cesium standard NBS-4 and the UTC(6600), a time scale consisting of nine commercial cesium clocks.

The first set of data was compiled based on a 32 day uninterrupted comparison between H3, NBS-4, and UTC(6600). These three sources were treated as independent clocks. By simultaneously comparing three independent clocks, it is possible to deduce the stability of each individual clock. The points shown in figure 5, which extend beyond averaging times of 10,000 seconds, represent the individual performance of H3 in a three-way intercomparison. The relations for determining the stability of an individual clock in a three-way comparison is [7]

$$\sigma_i^2 = \frac{1}{2} [\sigma_{ij}^2 + \sigma_{ik}^2 - \sigma_{jk}^2] \quad \text{Eq. 1}$$

The slight rise in σ_y of H3 at averaging times of about $\frac{1}{2}$ day and 1 day are most likely attributable to environmental effects (a diurnal). Day-to-day temperature and pressure changes appear to enter at about the 1×10^{-14} level. Although there is some degradation of stability for times around 1 day, the longer term stability is on an improving trend as shown by the last σ_y point at an averaging time of eight days (4 data samples). The eight-day value of σ_y is 8.1×10^{-15} ($\pm 5.6 \times 10^{-15}$).

Figure 6 and figure 7 show the frequency fluctuations as a function of time for H3. Figure 6 shows a comparison between H3 and NBS-4 and figure 7 is the comparison between H3 and UTC(6600). A more graphic comparative measure is the residual time fluctuations indicated in figure 8 and figure 9. Over the 32 day data run, figure 8 shows the time residual (taken from day-to-day epoch data) between H3 versus NBS-4. The time residuals are the integrated fractional frequency fluctuations. Figure 9 shows the same plot of time residuals between H3 and UTC(6600). To a large extent, the measurements of long-term stability are limited by the stabilities of NBS-4 and UTC(6600). The peak-to-peak time difference of H3 versus NBS-4 is 14 nanoseconds and the peak-to-peak difference of H3 versus UTC(6600) is 10 nanoseconds. For these long term data, the fluctuations are noticeably smoother in the comparison to the UTC ensemble of nine Cs clocks. The end points for these runs of data are deliberately set to return to zero time difference, thus removing an average frequency offset. In this 32 day data set, there appears to be correlated frequency changes of parts in 10^{15} with period of order 7 days. This possible effect is under further study.

Shorter term stability measurements (from 1 second to 10,000 seconds) on H3 and H4 consistently produced the straight solid line shown on the stability plot of figure 5. This is the white frequency behavior of the masers at $1.7 \times 10^{-12} \tau^{-\frac{1}{2}}$ and is the stability referred to each individual hydrogen maser. This individual stability was based on the three-way comparison among each: H3, H4, and NBS-4. NBS-4 has an individual stability of about $2.7 \times 10^{-12} \tau^{-\frac{1}{2}}$.

First attempts to compare H3 with H4 in a stability measurement uncovered a number of problems. These problems were evidently

associated with a cross-talk signal which affected the phase of the output of a maser when the other nearby maser was in operation and being compared. Virtually identical hardware exists in the generation of 1.420 GHz in each maser. This is accomplished in each by multiplying a quartz crystal oscillator at 4.93 MHz by 288. Non-linear amplification at various stages in the multiplication chain generates a spectrum of lines extending from 4.93 MHz to 1.420 GHz. Two such multiplier chains, located within close proximity of one another, present an opportunity for both to have a preferred common phase, if the two oscillators are very close in frequency. In the case of the masers here, the frequency difference between the two hydrogen masers is 5×10^{-12} or less. Stray rf coupling between oscillators/multipliers created a type of injection locking which was very troublesome. The multipliers were subsequently repackaged and additional shields applied around the input amplifiers. This has eliminated the problem.

CORRELATION STUDY

Long term measurements of environmental temperature and barometric pressure were made coincident with frequency in order to determine the level of sensitivity to these environmental effects. Interestingly, there is no perceivable barometric pressure effect to the 1×10^{-14} level limited by the length of the data set. The barometric pressure changed by 7% (maximum) during this 32 day comparison. Other parameters were adjusted and their effects on the maser frequency are summarized in Table 1.

SUMMARY OF SMALL PASSIVE MASER PERFORMANCE

<u>EFFECT</u>	<u>OFFSET</u>	<u>INSTABILITY</u>
1. Spin Exchange	2×10^{-13}	2×10^{-15}
2. Resonator Temperature Sensitivity	$< 3 \times 10^{-14}/K$	$2 \times 10^{-15}/K$
3. Magnetic Field	3×10^{-13} for $\pm 3 \times 10^{-5} T$ ($\pm 0.3G$)	10^{-15}
4. Power Dependence	$< 10^{-13}/dB$	10^{-15}
5. Phase Modulator Drive	$< 10^{-13}/dB$	10^{-15}

Frequency Stability: $\cong 1.7 \times 10^{-12} \tau^{\frac{1}{2}}$, $1 < \tau < 10^5$

Drift vs. UTC(NBS): $7 \pm 20 \times 10^{-16}/\text{day}$
17 day measurement
for H3 and also H4

TABLE 1

DRIFT

The long-term stability measurements presented in figure 5 represent a 32 day accumulation of data. In this data, a linear drift term of $4 \times 10^{-15}/\text{day}$ was removed. After degaussing, another measurement of 17 days was made which exhibited a drift vs UTC(NBS) of $7 \pm 20 \times 10^{-16}/\text{day}$ for both H3 and H4.

Based on separate long-term stability measurements made in a three-way comparison, the drift of the passive hydrogen masers is at most the same level as UTC(NBS) over several weeks against which it was compared. The uncertainty in this level is about 2×10^{-15} per day over several weeks limited by the day to day fluctuations of UTC(NBS).

The largest contributor to the originally observed drift of the H3 maser was due to the drift in the magnetic shields after moving the maser from one lab to another without degaussing. Degaussing in position apparently removed the drift. Environmental changes of temperature and pressure appear to affect the maser stability at the 1×10^{-14} level.

CONCLUSION

We have taken, and are continuing to take, intercomparative frequency stability measurements among four clocks; passive H3 and H4 hydrogen masers and NBS-4 and UTC(NBS). No appreciable drift above 2×10^{-15} per day has been detected. Some environmental sensitivity (pressure and temperature) affects frequency stability at about the 1×10^{-14} level. We have made considerable improvements in the original small passive maser design in the area of increased maser-to-maser isolation and increased environmental insensitivity. The preliminary long-term stability measurements presented here indicate great potential for the passive maser design as clocks. For the first time, small passive hydrogen masers will be contributors to the NBS time scale. In the future, we plan to deploy a full-size hydrogen maser (of passive design) also into the time scale. The large maser has the potential to perform with a stability of:

$$\sigma_y(\tau) = 1.3 \times 10^{-13} \tau^{-\frac{1}{2}} + 1 \times 10^{-15}, \quad 0 < \tau < 10^5 \text{ sec.}$$

ACKNOWLEDGEMENTS

The authors thank D. W. Allan and J. Levine for help in processing of clock comparison data. This work is partially supported by Jet Propulsion Laboratories, Pasadena, CA and Naval Research Laboratories, Washington, DC.

REFERENCES

1. F. L. Walls and H. Hellwig, "A New Kind of Passively Operating Hydrogen Frequency Standard," Proc. 30th Ann. Symp. on Freq. Control, 473, 1976.
2. F. L. Walls, "Design and Results from a Prototype Passive Hydrogen Maser Frequency Standard," Proc. 8th Ann. Precise Time and Time Interval (PTTI) Planning Meeting, 369, 1976.
3. D. A. Howe, F. L. Walls, Howard E. Bell, and Helmut Hellwig, "A Small, Passively Operated Hydrogen Maser," Proc. 33rd Ann. Symp. on Freq. Control, 554, 1979.
4. H. T. M. Wang, J. B. Lewis, and S. B. Crampton, "Compact Cavity for Hydrogen Frequency Standard," Proc. 33rd Ann. Symp on Freq. Control, 543, 1979.
5. E. M. Mattison, E. L. Blomberg, G. U. Nystrom, and R. F. C Vessot, "Design, Construction, and Testing of a Small Passive Hydrogen Maser," Proc. 33rd Ann. Symp. on Freq. Control, 549, 1979.
6. Harry E. Peters, "Small, Very Small, and Extremely Small Hydrogen Masers," Proc. 32nd Ann. Symp. on Freq. Control, 469, 1978.
7. James A. Barnes, et al., "Characterization of Frequency Stability," IEEE Trans on Instr. and Meas. IM-20, 105, 1971.

FIGURE CAPTIONS

- Fig. 1. In the passive mode, the H-maser is not oscillating. The NBS H3 and H4 electronics use two servo systems involving the narrow H-line and cavity separately.
- Fig. 2. A small cavity is realized by the addition of low-loss alumina dielectric.
- Fig. 3 The conventional H-maser storage bulb is eliminated and the wall of the open center is coated with Teflon.
- Fig. 4. Completed prototype cavity assembly with four nested magnetic shields.
- Fig. 5. Frequency stability of small H-maser based on 32 day comparison simultaneously against UTC(6600) and cesium standard NBS-4.
- Fig. 6. Daily frequency of H3 vs. NBS-4 (average frequency offset removed).
- Fig. 7. Daily frequency of H3 vs. UTC(6600) (average frequency offset removed).
- Fig. 8. Daily time of H3 vs. NBS-4 (average frequency offset removed).
- Fig. 9. Daily time of H3 vs. UTC(6600) (average frequency offset removed).

PASSIVE HYDROGEN MAGER

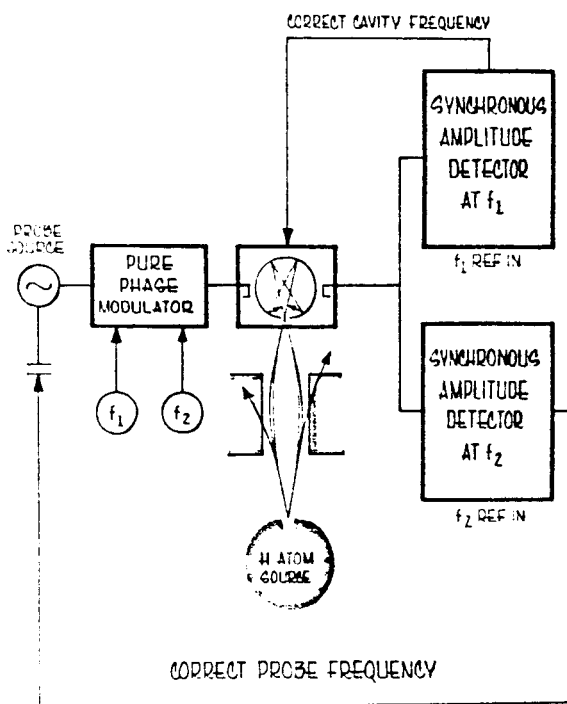

Fig. 1

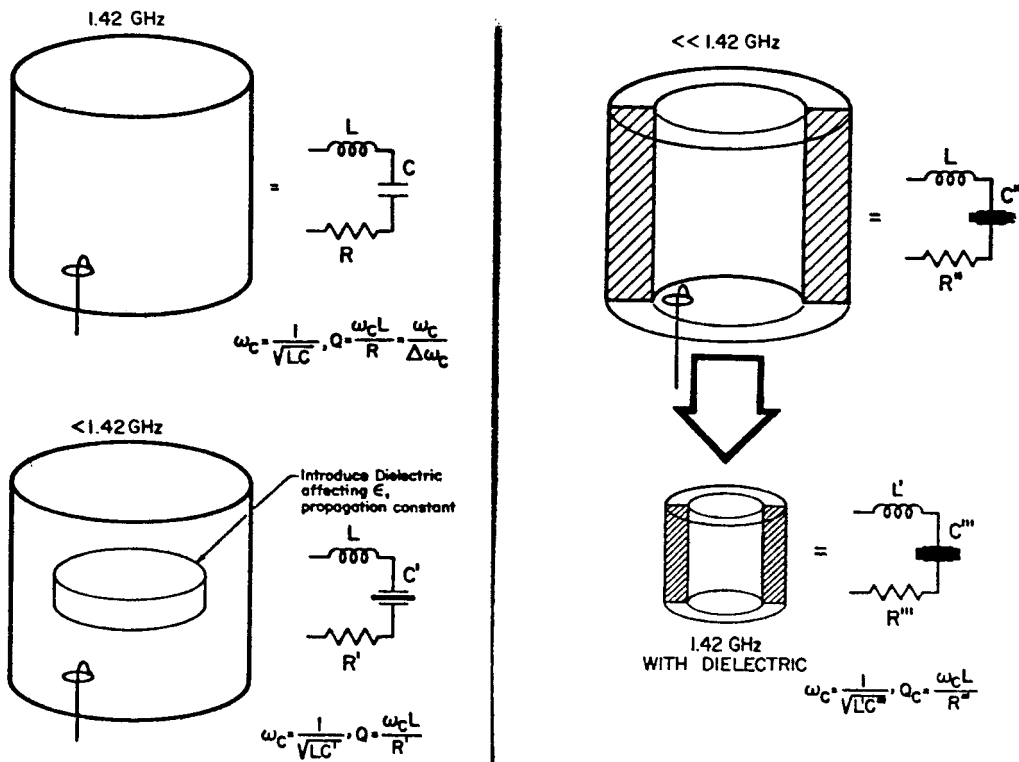
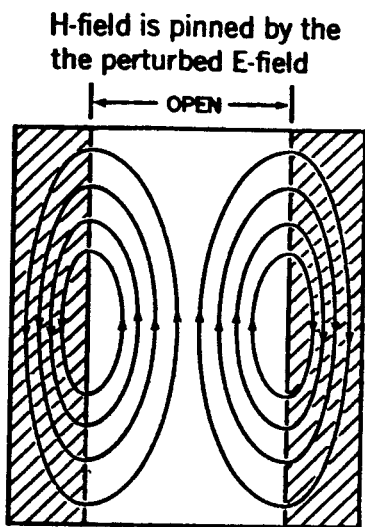

Fig. 2



A geometry is chosen so that
the oscillating H-field
does not reverse sign in the
open bore.

No bulb is needed to confine
the interrogated atoms to a
volume of non-reversing H-field,

Fig. 3

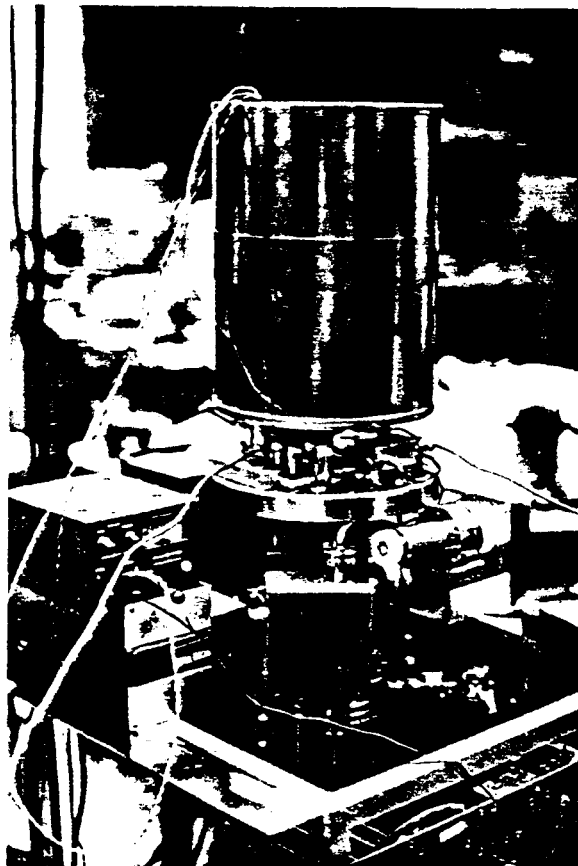

Fig. 4

NBS SMALL PASSIVE HYDROGEN MASER PERFORMANCE
 $1.7 \times 10^{-12} \tau^{-1/2}$

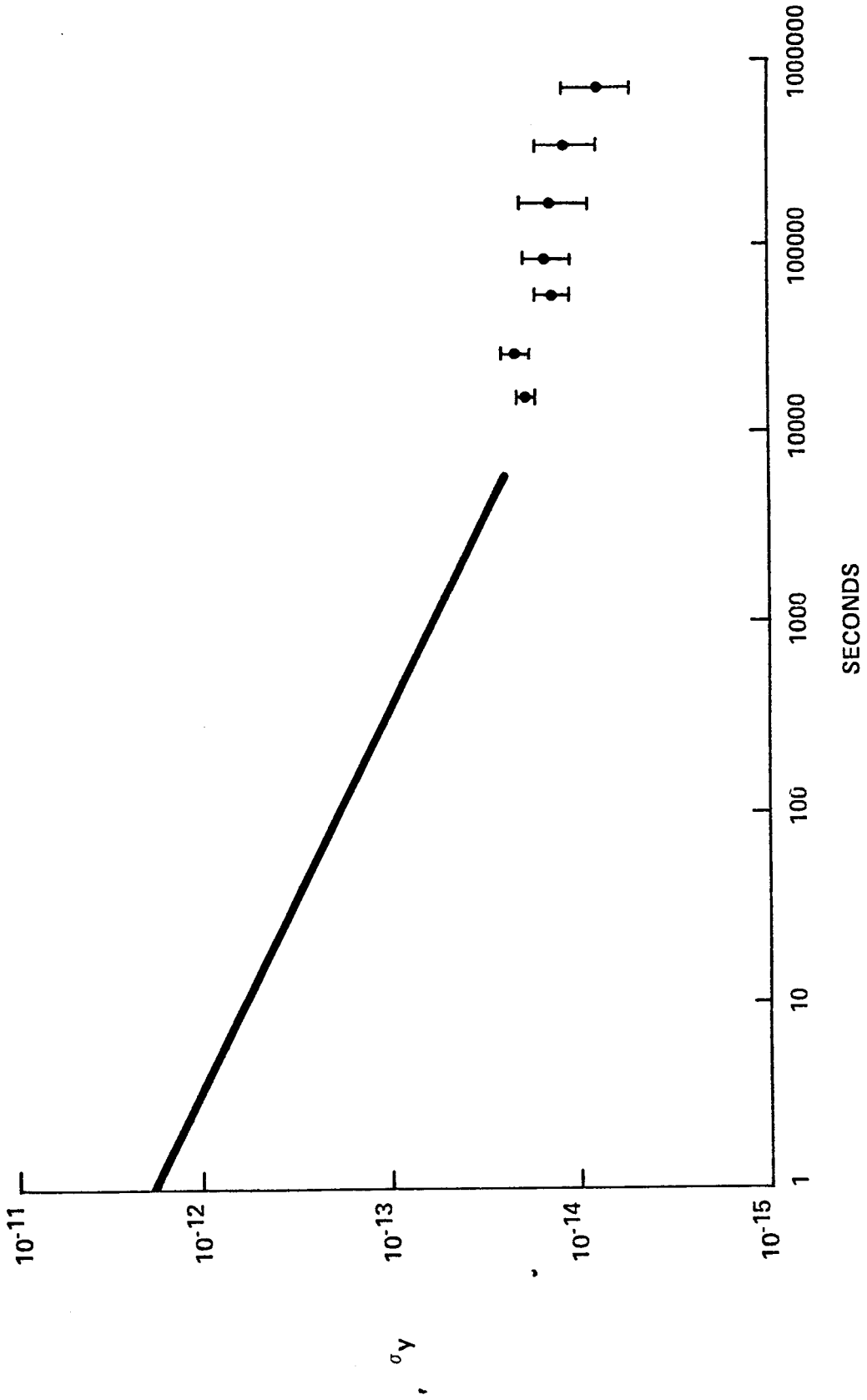

Fig. 5

SMALL PASSIVE MASER VS NBS-4

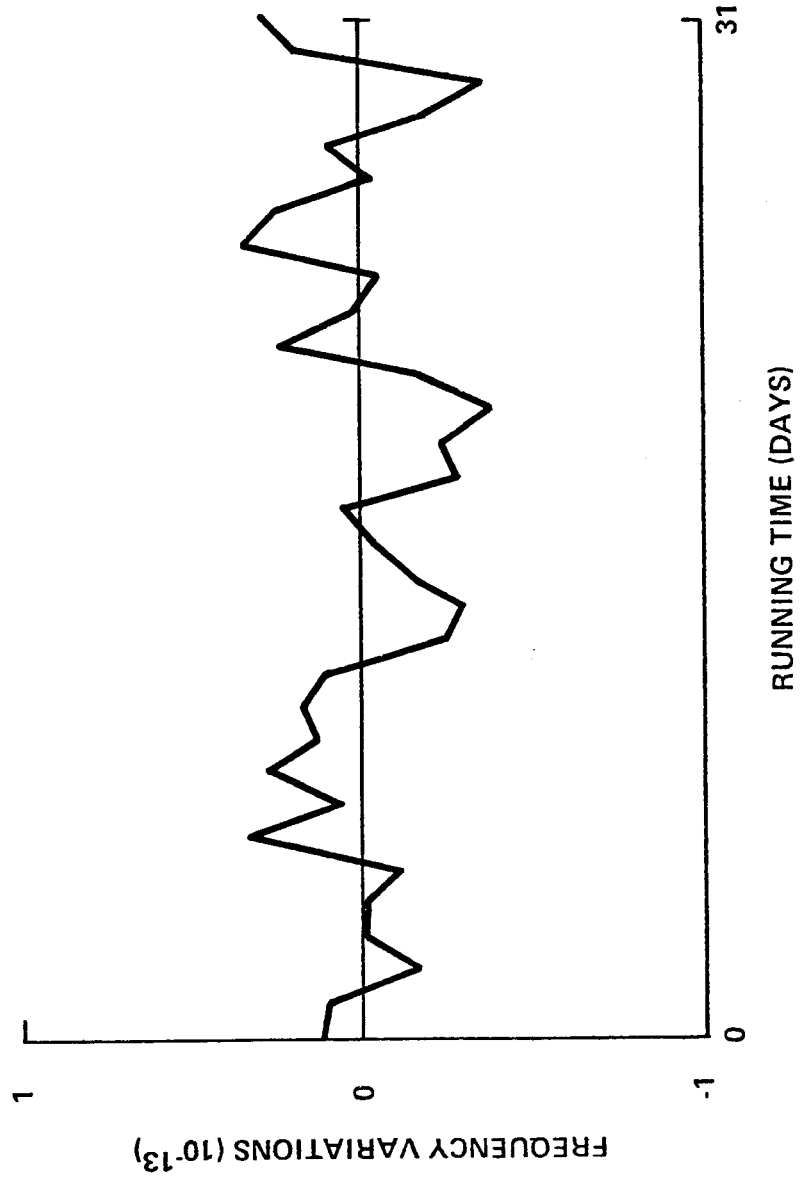

Fig. 6

SMALL PASSIVE MASER VS UTC (6600)

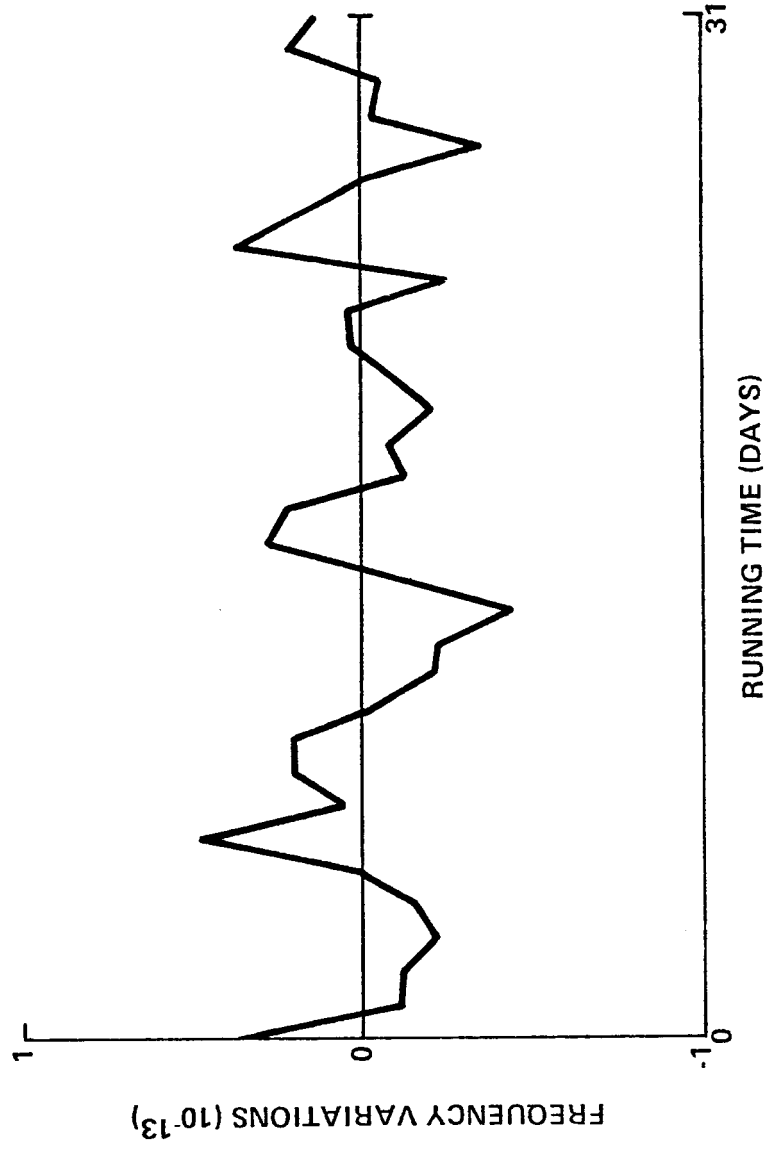
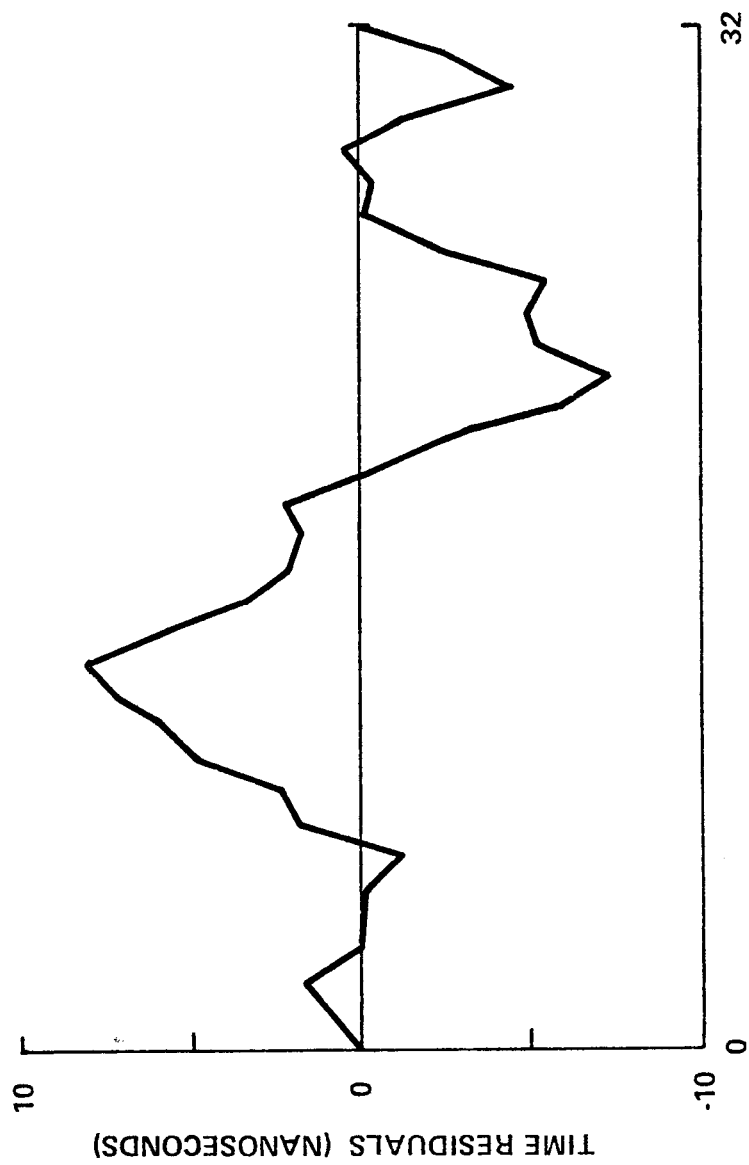

Fig. 7

SMALL PASSIVE MASER VS NBS-4



RUNNING TIME (DAYS)

Fig. 8

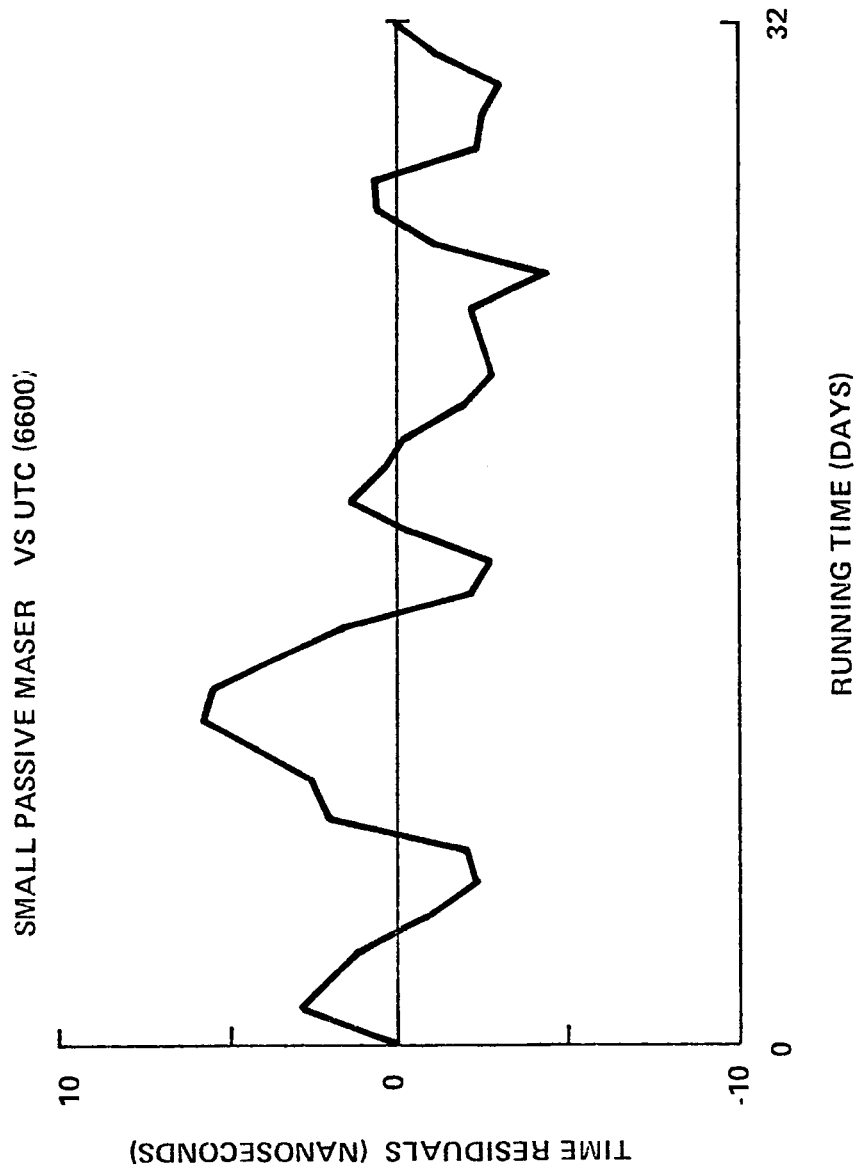

Fig. 9